

ASPPRO

19-20

ACSUD SACIM DISTRIBUTION



Un moteur de recherche performant étudié suivant vos besoins.

Un motore di ricerca performante studiato secondo le tue necessità

Une recherche par famille produit >
Una ricerca per famiglia di prodotti >



Pour consulter ou valider votre panier, cliquez sur le bouton " Voir mon panier "

Per consultare o convalidare il carrello clicca sul bottone «Visualizza il carrello»

Télécharger le guide d'utilisation
Scaricare il manuale d'uso

Votre espace personnel protégé.
Le tue credenziali sono protette



Entrez votre login et votre mot de passe pour vous connecter.
Inserisci login e password per accedere



< Une recherche par multi-mots
< Una ricerca per parole chiave

Vous pouvez saisir plusieurs mots pour rechercher un produit par désignation .

Exemple :

Saisissez
CYLINDRE FONTE CARENZI

Saisissez les quantités et cliquez sur le bouton

" Ajouter tout au panier "

Puoi inserire una o più parole per ricercare un prodotto.

Esempio :

Inserisci CILINDRO CARENZI

Inserisci le quantità e clicca sul bottone

«Aggiungere al carrello»





SOMMAIRE INDICE

	MOTEUR MOTORE	5 > 106
	PARTIE CYCLE PARTI CICLISTICA	107 > 164
	CARROSSERIE CARENA	165 > 198
	ELECTRICITE PARTE ELETTRICHE	199 > 228
	ECLAIRAGE LUCI	229 > 248
	FREINAGE FRENI	249 > 288
	PNEUMATIQUE PNEUMATICI	289 > 306
	MAINTENANCE MANUTENZIONE	307 > 322
	ANTIVOL ANTIFURTO	323 > 326
	EQUIPEMENT PILOTE ABBIGLIAMENTO MOTO	327 > 354
	OUTILLAGE ATTREZZI	355 > 364



- > Pièces type Origine
- > Ricambi Originali



- > Gamme Casques
- > Gamma Caschi



- > Pièces type Racing
- > Ricambi Racing



- > Pièces Moto type Origine
- > Ricambi Moto Originali



- > Gamme Antivols SRA / non homologués
- > Gamma Antifurti, Catene e Luchetti



- > Pièces Off Road
- > Ricambi ed Accessori Enduro/Cross



- > Gamme Gants Eté / Hiver
- > Gamma Guanti Estate / inverno



- > Pièces Racing / Tuning Maxiscooter
- > Ricambi e Parti Maxiscooter



- > Gamme Accessoires Pilote
- > Gamma Accessori Conducente



- > Pièces et Outillage Atelier
- > Attrezzatura per Officina

> INDEX

	PAGES		PAGES
ACCESSOIRES GY6	100 > 103	EMBRAYAGE	61 > 64
ACCESSOIRES POCKET	104	FEU DECORATIF	248
ACCESSOIRES PW 50/80	105 > 106	FEUX ARRIERES	237 > 240
ADMISSION	89 > 91	FIL DE BOUGIE	211
ALARME	227	FILTRE A AIR	91 > 99
ALLUMAGE	215 > 219	FILTRE A HUILE	74 > 75
AMORTISSEUR	14 > 143	FILTRE ESSENCE	88
AMPOULE	230 > 231	FOURCHE	145 > 147
ANTIVOL	324 > 326	FREIN A DISQUE	282 / 288
BATTERIE	201 > 207	FREIN A PIED	288
BEQUILLES	149 > 151	GALET DE VARIATEUR	60
BLOC CDI	221	GANTS	328 > 336
BOBINE	221	GARDE-BOUE	153
BOITE DE VITESSE	54	GUIDON	125
BOUCHON D'HUILE	51	HOUSSE	155
BOUCHON DE RESERVOIR	88	HUILE & LUBRIFIANT	308 > 314
BOUGIE	208 > 209	IMMATRICULATION	153
CABLE	117	INJECTEUR	86
CABLE TRANSMISSION	118	INTERRUPTEUR	211
CABOCHONS	211 / 241 > 244	JANTE	148
CACHE PIGNON	52	JEU DE DIRECTION	148
CAGOULE	353	JOINT	40 > 46
CAPUCHON DE BOUGIE	211	JOINT "SPY"	40 / 147
CARBURATEUR & PIECES CARBURATEUR	76 > 84	KICK	56
CARROSSERIE *BOOSTER / BW'S 99 2003	170 > 172	KIT CHAINE	112
CARROSSERIE *BOOSTER 2004 / BW'S	173 > 174	LEVIER	119 > 123
CARROSSERIE *CPI	189	MAINTENANCE ENTRETIEN	316 > 320
CARROSSERIE *DERBI SENDA	187 > 188	MACHOIRE DE FREIN	250 > 251
CARROSSERIE *LIBERTY 50	185	MASQUE PILOTE	351 > 352
CARROSSERIE *LUDIX AIR COOLED	166	MENBRANE DE CARBURATEUR	83
CARROSSERIE *MACH G / JOG R	183	MOUSSE DE FILTRE A AIR	97 > 99
CARROSSERIE *NEXT / ROCKET	175	MOUSSE DE GUIDON	127
CARROSSERIE *NITRO / AEROX	178 > 181	OPTIQUE	234 > 236
CARROSSERIE *OVETTO	182	OUTILLAGE ATELIER	356 > 363
CARROSSERIE *PCX 125	198	PARE-BRISE	163 > 164
CARROSSERIE *RIEJU	189	PEINTURE	321
CARROSSERIE *SH 125/105 > 08	196	PIGNON	110 > 117
CARROSSERIE *SH 300i	197	PISTON	22 > 33
CARROSSERIE *SPEEDFIGHT 2	168 > 169	PIPE D'ADMISSION	89 > 91
CARROSSERIE *STALKER	181	PLAQUETTE DE FREIN	252 > 281
CARROSSERIE *STUNT	176 > 177	PNEUS & CHAMBRE A AIR	290 > 304
CARROSSERIE *T-MAX 500	192 > 195	POIGNEE DE GAZ	123 > 124
CARROSSERIE *TREKKER	167	POMPE A EAU	49 > 50
CARROSSERIE *TYPHOON / NRG / NTT / MC2 EXTREME	182	POMPE ESSENCE	86
CARROSSERIE *X-MAX	190 > 191	POMPE A HUILE	51
CARROSSERIE *ZIP	184	PONTET DE GUIDON	125 > 126
CARTER ALLUMAGE	52	POTENCE	126
CARTER DE CHAINE	108	POULIE	65
CARTER MOTEUR	46	PROTEGE MAIN	128 > 164
CARTER POMPE A EAU	48	RADIATEUR	50
CARTER POMPE A HUILE	51	REFROIDISSEMENT	48 > 50
CARTER VARIATEUR	47	REGULATEUR DE TENSION	220
CASQUE	338 > 350	REHAUSSEUR D'AMORTISSEUR	144
CHAINE	108	RELAIS	213
CLAPET	89 > 91	REPARATION PNEUMATIQUE	305 > 306
CLIGNOTANT	245 > 248	REPOSE PIED	152
CONTACTEUR A CLÉ	223 > 235	RESSORT	61
CONTACTEUR DE STOP	212	RETROVISEUR	135 > 140
COMMUTATEUR	222	REVETEMENT	129 > 134
COMMUTATEUR DE CONTACTEUR A CLE	225	ROBINET ESSENCE	86 > 87
COMPTEUR	226 > 227	ROULEMENT	39 > 40 / 144
COURROIE	66 > 72	STARTER	83
COURONNE	109 > 117	SEGMENT	22 > 33
COUPE-CIRCUIT	212	SELECTEUR DE VITESSE	57
COUVERCLE DE RESERVOIRE DE FREIN	288	SELLE	155
COUVRE RAYON	127	TABLIER	162
COUVRE SELLE	154	TETE DE FOURCHE	232 > 233
CULASSE	33	TRANSMISSION RB MAX	65
CYLINDRE	22 > 31	TOP CASE	157 > 162
DEMARREUR	54 > 55 / 214	VARIATEUR	58 > 59
DISQUE DE FREIN	282 > 287	VETEMENT DE PLUIE	253
DURITE	88	VILEBREQUIN	24 > 39
ECHAPPEMENT	6 > 20	VIS	47
EMBOUT DE GUIDON	126		

• Certains de nos produits sont photographiés "montés" sur les cyclos et les scooters de marques PEUGEOT, MBK, VESPA, PIAGGIO, etc ... dans un but de simple présentation et peuvent cotôyer des pièces appartenant à d'autres marques. Toutes les photos sont non-contractuelles.

• Les produits non signalés comme "HOMOL." ou "HOMOLOGUE" figurant dans ce catalogue ne doivent pas être utilisés sur la Voie Publique (où leur usage est interdit) ni sur les espaces ouverts à la circulation des personnes (chemin, parking, etc...).

• *ADAPTABLE
Tous les produits présentés dans ce catalogue sont du type "ADAPTABLE". Ils ne sauraient en aucun cas être considérés comme de vraies "PIECES D'ORIGINE".

> INDICE

	PAGINE		PAGINE
ACCESSORI GY6	100 > 103	FORCELLA	145 > 147
ACCESSORI POCKET	104	FRECCE	245 > 248
ACCESSORI PW 50/80	105 > 106	FRENO A DISCO	282 / 288
ABBIGLIAMENTO PIOGGIA	253	FRIZIONE	61 > 64
ACCELERATORE	123 > 124	GANASCE FRENO	250 > 251
ACCENSIONE	215 > 219	GEMME FARO	211 / 241 > 244
ALBERO MOTORE	24 > 39	GUANTI	328 > 336
ALLARME	227	GUARNIZIONI	40 > 46
AMMORTIZZATORE	14 > 143	INIEZIONE	86
ANTIFURTO	324 > 326	INTERRUTTORE	211
ASPIRAZIONE	89 > 91	INTERRUTTORE EMERGENZA	212
ATTREZZI OFFICINA	356 > 363	KIT CATENA PIGNONE CORONA	112
BATTERIA	201 > 207	KIT SERRATURE	222
BAULETTO	157 > 162	KIT SERRATURE / CONTATTO CHIAVE	225
BOBINA	221	LAMPADINA	230 > 231
CAMBIO DE VELOCITA	54	LEVA M/M	56
CANDELA	208 > 209	LEVE	119 > 123
CARBURATORE & RICAMBI CARBURATORE	76 > 84	LUCI TUNING	248
CARENA *BOOSTER / BW'S 99 2003	170 > 172	MANOPOLE	129 > 134
CARENA *BOOSTER 2004 / BW'S	173 > 174	MANUBRIO	125
CARENA *CPI	189	MANUTENZIONE	316 > 320
CARENA *DERBI SENDA	187 > 188	MARMITTA	6 > 20
CARENA *LIBERTY 50	185	MASCHERA FARO	232 > 233
CARENA *LUDIX AIR COOLED	166	MENBRANA CARBURATORE	83
CARENA *MACH G / JOG R	183	MESSA IN MOTO	54 > 55 / 214
CARENA *NEXT / ROCKET	175	MOLLE	61
CARENA *AEROX / NITRO	178 > 181	OCCHIALI	351 > 352
CARENA *NEO'S	182	OLIO & LUBRIFICANTE	308 > 314
CARENA *PCX 125	198	PACCO LAMELLARE	89 > 91
CARENA *RIEJU	189	PARA COLPI MANUBRIO	126
CARENA *SH 125/105 2006	196	PARABREZZA	163 > 164
CARENA *SH 300i	197	PARAFANGO ANTERIORE	153
CARENA *SPEEDFIGHT 2	168 > 169	PARAOLIO	40 / 147
CARENA *STALKER	181	PASTIGLIE FRENO	252 > 281
CARENA *STUNT	176 > 177	PEDALE FRENO	288
CARENA *T-MAX 500	192 > 195	PEDALINE	152
CARENA *TREKKER	167	PIGNONE	110 > 117
CARENA *TYPHOON / NRG / NTT / MC2 EXTREME	182	PIPETTA CANDELA	211
CARENA *X-MAX	190 > 191	PISTONE	22 > 33
CARENA *ZIP	184	PNEUMATICI & CAMERE D'ARIA	290 > 304
CARTER ACCENSIONE	52	POMPA ACQUA	49 > 50
CARTER MOTORE	46	POMPA BENZINA	86
CARTER POMPA ACQUA	48	POMPA OLIO	51
CARTER POMPA OLIO	51	PORTA TARGA	153
CARTER VARIATORE	47	PROTEGGI CATENA	108
CASCHI	338 > 350	PROTEGGI MANI	128 > 164
CATENA	108	RADIATORE	50
CAVALLETTO	149 > 151	RAFFREDDAMENTO	48 > 50
CAVI	117	REGOLATORE DI TENSIONE	220
CAVO TRASMISSIONE	118	RELÈ	213
CENTRALINA	221	RETROVISORI	135 > 140
CERCHIO	148	RIALZO AMMORTIZZATORE	144
CILINDRO	22 > 31	RIPARAZIONE PNEUMATICO	305 > 306
CINGHIA	66 > 72	RUBINETTO BENZINA	86 > 87
CINGHIA PULEGGIA	65	RULLI VARIATORE	60
COLLETTORE D'ASPIRAZIONE	89 > 91	SEGMENTI	22 > 33
CONTATTO CHIAVE	223 > 235	SELETTORE DI VELOCITÀ	57
CONTATTO STOP	212	SELLA	155
CONTRAPPESI MANUBRIO	126	SOTTO CASCO	353
COPERCHI POMPA FRENO	288	SPUGNA FILTRO ARIA	97 > 99
COPRI PIGNONE	52	SPUGNA MANUBRIO	127
COPPRI RAGGI	127	STARTER	83
COPRI SELLA	154	STRUMENTAZIONE	226 > 227
COPRIGAMBE	162	SUPPORTI MANUBRIO	125 > 126
CORONA	109 > 117	TAPPO OLIO	51
CUSCINETTI DI DIREZIONE	148	TAPPO SERBATOIO	88
CUSCINETTO RUOTA	39 > 40 / 144	TELO COPRI MOTO	155
DISCO FRENO	282 > 287	TESTA	33
FARO ANTERIORE	234 > 236	TRASMISSIONE RB MAX	65
FARO POSTERIORE	237 > 240	TUBO BENZINA	88
FILO CANDELA	211	VARIATORE	58 > 59
FILTRO ARIA	91 > 99	VERNICE	321
FILTRO BENZINA	88	VITI	47
FILTRO OLIO	74 > 75		

• Alcuni nostri prodotti sono fotografati "montati" su bici e scooter di marca PEUGEOT, MBK, VESPA, PIAGGIO, ecc... a scopo di semplice presentazione e possono essere accostati a pezzi di altre marche. Tutte le foto sono non contrattuali.

• I prodotti non segnalati come "OMOL." od "OMOLOGATO" in questo catalogo non devono essere usati su strade pubbliche (dove vietato) ne su spazi aperti alla circolazione delle persone (cammini, parcheggi, ecc...).

• *COMPATIBILE
Tutti i prodotti presentati in questo catalogo sono di tipo "COMPATIBILE". Non sono in nessun caso da considerare come "PEZZI ORIGINALI".



MVT

GAMME MVT IRONMAX EN FONTE POUR UNE UTILISATION "ALLDAYS"

Modèle	HM Alu	HM Fonte	Vilebrequin	Admission	Echappement	Embrayage
Mina-Vertical		033006	090980F	35627 D.19mm 35627 D.28mm	014400D	35455 50/80cc D.107mm
Mina-Horizontal H20	035584	033009	090980D D.10mm	110440 D.19mm 090980E D.12mm	0144008 0110440A	35455 50/80cc D.107mm
Ludix H20	033003		090980H	35626 D.19mm	014400E	
AM6	033001	033007	090980*	110450 D.19mm 35627A D.28mm	014500A	35453 50cc 35453A 80cc
Derbi E2	033000		090980C	110450A D.19mm 35627B D.28mm	0145500	35452 50cc 35452A 80cc
Derbi E3	033002	033008	090980G	110450A D.19mm 35627B D.28mm	0145500	35452 50cc 35452A 80cc

*Nécessite rouf. 6204

GAMME IRON MAX

	AM6 50	Derbi E3 50	Aerox 50	BW's 50
Moteur	IM1	IM2	IM51	M6
Echappement	EC01	EC02	EC51	EC31
Carburateur	19	19	17,5	17,5
Admission	CL01	CL02	CL03	CL08
Allumage	EXT112/121	EXT111	EXT107/12	EXT106/119
Vilebrequin	VI01	VI13	VI05	VI08
Embrayage	EMB01	EMB02	EMB03	EMB03



GAMME S-RACE

	AM6 50	Derbi E2 50	Derbi E3 50	Ludix LC	Ludix Air	BW's 50	Aerox 50	103 G1	MBK 51 G1
Moteur	HM1		HM3				HM17	HM33	HM34
Echappement	EC01	EC02	EC02	EC61	EC61	EC31	EC51	EC16	EC17
Carburateur	28	28	28	21	21	17,5/21	17,5/21	21	21
Admission	CL10	CL20	CL20	CL04	CL04	CL08	CL03	CL09	CL11
Allumage	DD12/21	DD11	DD11	PREM10	PREM10	PREM06/19	PREM06/19	PREM02/03	PREM01
Vilebrequin	VI01	VI02	VI13	VI19	VI19		VI08		
Embrayage	EMB01	EMB02	EMB02			EMB03	EMB03		

MVT Service technique MVT - Tél : 0034 972 534 212

MOTEUR

- > POT D'ÉCHAPPEMENT
- > CYLINDRE
- > CULASSE
- > PISTON & SEGMENT
- > VILEBREQUIN
- > ROULEMENT
- > JOINT
- > CARTER MOTEUR
- > CARTER VARIATEUR
- > REFROIDISSEMENT
- > POMPE A EAU
- > CARTER POMPE A HUILE
- > CARTER ALLUMAGE
- > CARTER CHAINE
- > DEMARREUR
- > KICK
- > SELECTEUR DE VITESSE
- > VARIATEUR
- > EMBRAYAGE
- > COURROIE
- > FILTRE A HUILE
- > ADMISSION
- > POCKET BIKE PIECES
- > KIT TRANSMISSION
- > CARBURATEUR
- > BOUCHON ESSENCE
- > ROBINET ESSENCE
- > POMPE ESSENCE
- > FILTRE ESSENCE
- > FILTRE A AIR

MOTORE

- > MARMITTA
- > CILINDRO
- > TESTA
- > PISTONE & SEGMENTI
- > ALBERO MOTORE
- > CUSCINETTI
- > GUARNIZIONI
- > CARTER MOTORE
- > CARTER VARIATORE
- > RAFFREDDAMENTO
- > POMPA ACQUA
- > CARTER POMPA OLIO
- > CARTER ACCENSIONE
- > CARTER CATENA
- > MESSA IN MOTO
- > LEVA M/M
- > SELETTORE DI VELOCITA
- > VARIATORE
- > FRIZIONE
- > CINGHIA
- > FILTRO OLIO
- > ASPIRAZIONE
- > RICAMBI POCKET BIKE
- > KIT DI TRASMISSIONE
- > CARBURATORE
- > TAPPO BENZINA
- > RUBINETTO BENZINA
- > POMPA BENZINA
- > FILTRO BENZINA
- > FILTRO ARIA

MOTEUR MOTORE POT D'ÉCHAPPEMENT SCOOTER MARMITTA SCOOTER

TNT
Original

Conception identique à l'origine, excellent rapport qualité/prix

- Structure acier
- Bas niveau sonore
- Résistance et durabilité
- Homologué CE selon la directive 97/24/EC

Concezione identica all'originale, eccellente rapporto qualità/prezzo

- Struttura in acciaio
- Contenuto livello sonoro
- Resistente e duratura
- Omologazione CE secondo le direttive 97/24/EC



013050A	*MINARELLI Vert. BOOSTER / STUNT
013051A	*MINARELLI Horiz. NITRO / OVETTO
013071A	*PEUGEOT LUDIX AIR / H2O / JET FORCE
013060A	*PEUGEOT SPEEDFIGHT / TREKKER / ELYSEO
013055A	*PIAGGIO TYPHOON/NRG/STALKER



013055B CHROME



*PEUGEOT 103 VOGUE
S70151



POT ECHAPPEMENT COMPLET MOTEUR 4T 50CC
971163L MOTEUR 139QMB/A



*SOLEX 3800
S3800



*PEUGEOT 103 COBRA 3
012105



*MBK 51
012110



*MBK 51 DAKOTA
012110A



*MBK 51
S700051



*PIAGGIO CIAO PX
010500

MOTEUR MOTORE POT D'ÉCHAPPEMENT SCOOTER MARMITTA SCOOTER

SILENCERS **SITO**



013030M	*KYMCO AGILITY 50 ROUES DE 12"	SITO 737
013030J	*KYMCO DINK / VITALITY	SITO 701
013030I	*MINARELLI Horiz. OVETTO / NITRO FIN 99	SITO 587
013030C	*MINARELLI Horiz. NITRO/AEROX 2004	SITO 716
013030B	*MINARELLI Horiz. OVETTO/NEOS >2003	SITO 574
013043	*MINARELLI Vert. STUNT/SLIDER	SITO 590
013041	*MINARELLI Vert. BOOSTER / BW'S	SITO 559
013041A	*MINARELLI Vert. BOOSTER / BW'S 2004	SITO 715
013030A	*PEUGEOT JET FORCE / LUDIX BLASTER	SITO 723
013030G	*PEUGEOT LUDIX ONE	SITO 714
S70711	*PEUGEOT SPEEDFIGHT 2 / X-FIGHT	SITO 711
013030H	*PEUGEOT SPEEDFIGHT	SITO 588
013030	*PEUGEOT BUXY / TREKKER	SITO 568
013042B	*PIAGGIO NRG MC2 EXTREME H2O / SCARABEO STREET 50 07	SITO 586
013042A	*PIAGGIO NRG MC2 / ZIP / TYPHOON 03 / STALKER	SITO 572
013042	*PIAGGIO TYPHOON < 2003	SITO 554
013030D	*PIAGGIO / ET2	SITO 264
013030F	*VESPA 50 / ET4 / LIBERTY 50	SITO 713
013030E	*VESPA 125 / ET4 / LIBERTY	



NOENO

**BANDE THERMIQUE POUR COLLECTEUR
NASTRO TERMICO ISOLANTE CHIARO**

20MM X 50MM X 3M

013100 BLANC BIANCO

013100A NOIR NERO

017902 SILENCIEUX ECHAPPEMENT VINTAGE NOIR MAT ADAPT Ø26 - 45MM UNIVERSEL

* Adaptable
* Adattabile

Les références du constructeur sont seulement indicatives et n'impliquent pas que les pièces de rechange viennent du constructeur.
I codici di riferimento originali sono indicativi e non implicano che i ricambi provengano necessariamente dalla stessa fabbrica del costruttore.

AS 7

MOTEUR MOTORE

POT D'ÉCHAPPEMENT SCOOTER MARMITTA SCOOTER

> LEOVINCE TOURING



013043F	*BOOSTER / BWS / STUNT
013043E	*GILERA / PIAGGIO RUNNER
013043D	*GLILERA / TYPHOON / STORM / NTT / ZIP SP
013043A	*OVETTO / NEOS
013043B	*SQUAB / SPEEDFIGHT
013043C	*VESPA 50 ET2 / LX



> LEOVINCE TT



S704091	*BOOSTER 2004>
S704088	*LUDIX
S704039	*NITRO/AEROX/KEEWAY FOCUS 2001>
S704064	*TYPHOON

MOTEUR MOTORE

POT D'ÉCHAPPEMENT SCOOTER MARMITTA SCOOTER

> MVT S-ROAD



Race and Run !

Corps gros volume en acier 12/10.
Destinée au scooters 50cc
homologué aux normes CE.

Race and Run !

Espansione di grande volume in acciaio 12/10
Per scooter 50cc 2t
Omologazione CE secondo le direttive 97/24/EC



MVT ROAD

014400B *NITRO / AEROX / JOG / MACH G
014400C *GRIDO MOTEUR ASIATIQUE 1PE40QMB 2T
014400D *BOOSTER

> POT D'ÉCHAPPEMENT 50CC A BOITE MARMITTA 50CC A MARCE > MVT S-ROAD



Développé par le Service Course MVT, le S-ROAD est un pot qui change radicalement le comportement des moteurs grâce à une innovation interne. Il offre une grande plage d'utilisation, tout en conservant un niveau sonore similaire à l'origine.
Produit en tôle d'acier et roulé Soudé à la main.
Le S-ROAD allie la simplicité de montage grâce à sa technologie MD10 montage en moins de 10 minutes à la beauté et la performance.

Sviluppato dal Servizio Corse MVT, S ROAD è uno scarico che cambia radicalmente il comportamento del motore, grazie ad una innovazione interna, offre un gran ventaglio di utilizzo, sempre conservando un livello sonoro simile all'originale.
Prodotto in lamiera d'acciaio con saldature a tig eseguite a mano.
S ROAD combina facilità di montaggio con la sua tecnologia MD10 (Montaggio in meno di 10 minuti) alla bellezza e le prestazioni.



014500	*DERBI SENDA	BAS
014500A	*MINARELLI AM6	BAS
014500B	*CPI SM	BAS

CARTOUCHE SILENZIATORE

014505 L. 350 MM

* Adaptable
* Adattabile

Les références du constructeur sont seulement indicatives et n'impliquent pas que les pièces de rechange viennent du constructeur.
I codici di riferimento originali sono indicativi e non implicano che i ricambi provengano necessariamente dalla stessa fabbrica del costruttore.

> CARENZI DAEMON**CARENZI****Ligne Racing et rapport qualité/prix excellent !**

Silencieux :

- Aluminium noir satiné L.270 mm
- Collier de fixation inox
- Fixation 2 vis sur bride aluminium
- Gravure laser Carenzi

Corps :

- Tôle Acier emboutie, soudure mécanique TIG
- Vernis haute température
- Platine de fixation aluminium sur silentbloc
- Homologué normes CE

Linea Racing con ottimo rapporto qualità/prezzo !

Silenziatori :

- Alluminio nero satinato (L.270 mm)
- Collare di fissaggio in inox
- Viti sulla culatta terminale in alluminio
- Incisione laser Carenzi

Corpo :

- Lamiera stampata con saldatura a TIG meccanica
- Vernici ad alta temperatura
- Piastra di fissaggio in alluminio con silentbloc
- Omologazione CE

**CARTOUCHE SILENZIATORE**

017181 ALU ALLUMINIO

CARENZI

017270 *BOOSTER / MINARELLI Vert.

017271 *NITRO / MINARELLI Horiz.

017272 *TYPHOON

017273 *SPEEDFIGHT

017274 *LUDIX

017275 *GRIDO

017270A SILENCIEUX SILENZIATORE

MOTEUR MOTORE

POT D'ÉCHAPPEMENT 50CC A BOITE MARMITTA 50CC A MARCE

> CARENZI DAEMON EVO

CARENZI

Artisanal, performant, design exclusif !

Silencieux :

- Aluminium noir satiné L.300 mm
- Collier de fixation inox
- Embout inox brossé
- Cerclage inox riveté
- Sticker Carenzi haute température

Corps :

- Tôle Acier P04 10/10eme, roulé-soudé à la main
- Vernis haute température
- Manchon corps/silencieux caoutchouc
- Homologué normes CE

Artigianale, performante, dal design esclusivo !

Silenziatori :

- Alluminio nero satinato (L.300 mm)
- Collare di fissaggio in inox
- In acciaio inox lucidato
- Raggiature in acciaio rivettate
- Adesivi Carenzi specifici per alta temperatura

Corpo :

- In lamiera d'acciaio 10/10, saldatura a tig effettuata a mano
- Vernici ad alta temperatura
- Silentbloc in caucciù
- Omologazione CE



PASSAGE BAS PASSAGGIO BASSO

017702 *AM6 / RIEJU / BETA / YAMAHA DTR

017703 *DERBI SENDA / GILERA SMT



SILENCIEUX SILENZIATORE CARENZI DAEMON EVO

017702B



BRIDE ÉCHAPPEMENT EXHAUST CLAMP

019949 AM6 SUR CPI SM/SX



COLLIER COLLARE Ø60

017702A CARENZI DAEMON EVO



KIT FIXATION KIT DI FISSAGGIO

017702C *AM6



KIT FIXATION KIT DI FISSAGGIO

017702D *YAMAHA DTR



KIT FIXATION KIT DI FISSAGGIO

017702E *DERBI SENDA

* Adaptable
* Adattabile

Les références du constructeur sont seulement indicatives et n'impliquent pas que les pièces de rechange viennent du constructeur.
I codici di riferimento originali sono indicativi e non implicano che i ricambi provengano necessariamente dalla stessa fabbrica del costruttore.

MOTEUR MOTORE POT D'ÉCHAPPEMENT SCOOTER MARMITTA SCOOTER

> YASUNI R

YASUNI

Le «R» est une évolution du «Z», avec un volume plus important et un cône plus large, un complément idéal pour les cylindres Sport/MidRace.

Il fonctionne parfaitement avec les cylindres de 50 ou 70 cc, mais c'est sur les cylindres Sport de 70 cc qu'il exprime véritablement tout son potentiel.

Pour un rendement optimal, il est conseillé de modifier le rapport du variateur.

Avec certificat d'homologation. Il est équipé d'un silencieux en aluminium d'excellente qualité.

Également disponible en Noir, Carbone ou en Carbone-Kev.

L «R» è un'evoluzione dello «Z», con un volume più importante ed un cono più largo, un supplemento ideale per i cilindri Sport/Medi. Funziona perfettamente con i cilindri da 50 o 70 cc, ma è sui cilindri Sport di 70 cc che esprime veramente tutto suo potenziale. Per un rendimento ottimale, è consigliato di modificare il rapporto del variatore. Con certificato di omologazione. È fornito di un silenziatore in alluminio di eccellente qualità. Disponibile anche in versione Nero, Carbonio o in Carbonio-Kev.



YASUNI R EMBOUT ALUMINIUM

017811	*BOOSTER / MINARELLI Vert.
017831	*MBK NITRO - MINARELLI Horiz.
017802	*PEUGEOT BUXY - SPEEDAKE-SPEEDFIGHT
017817	*PIAGGIO NRG-NTT-TYPHOON-ZIP



YASUNI R EMBOUT ALUMINIUM BLACK

017812	*MBK BOOSTER - MINARELLI Vert.
017832	*MBK NITRO - MINARELLI Horiz.



YASUNI R EMBOUT CARBON

017813	*BOOSTER / MINARELLI Vert.
017833	*MBK NITRO - MINARELLI Horiz.



YASUNI R EMBOUT CARBON / KEVLAR

017814	*BOOSTER / MINARELLI Vert.
017818	*PIAGGIO NRG-NTT-TYPHOON-ZIP

MOTEUR MOTORE POT D'ÉCHAPPEMENT SCOOTER MARMITTA SCOOTER

> YASUNI Z

YASUNI

Le «Z» est un échappement étonnamment puissant qui ne nécessite aucune autre préparation.

Il fonctionne également avec un cylindre «Big Bore» Avec certificat d'homologation.

Il est équipé d'un silencieux en aluminium d'excellente qualité. Également disponible en Noir, Carbone ou en Carbone-Kev.

Lo «Z» è uno scarico straordinariamente potente che non necessita di nessuna altra preparazione.

Funziona bene anche con un cilindro Maggiorato

Con certificato di omologazione. È fornito di un silenziatore in alluminio di eccellente qualità. Disponibile anche in versione Nero, Carbonio o in Carbonio-Kev.



YASUNI Z EMBOUT ALUMINIUM

017809	*BOOSTER / MINARELLI Vert.
017828	*MBK NITRO - MINARELLI Horiz.
017801	*PEUGEOT BUXY - SPEEDAKE-SPEEDFIGHT
017816	*PIAGGIO NRG-NTT-TYPHOON-ZIP



YASUNI Z EMBOUT ALUMINIUM BLACK

017810	*MBK BOOSTER - MINARELLI Vert.
017829	*MBK NITRO - MINARELLI Horiz.



YASUNI Z EMBOUT CARBON

017830	*MBK NITRO - MINARELLI Horiz.
--------	-------------------------------

> YASUNI ECO

YASUNI

Nouveaux pots Yasuni ECO type standard, homologués CEE. Très bon rapport qualité / prix / performance. Plaque de protection percée avec logo gravé Yasuni. Peinture noire haute température pour résister longtemps dans le temps. Disponible pour un grand nombre de modèles de scooters.

Nuove marmitte Yasuni ECO, omologate CE. Ottimo rapporto qualità / prezzo / rendimento. Piastra di protezione incisa a rilievo con logo Yasuni. Vernice nera alta temperatura top quality per lunga durata.

Disponibi per una vasta gamma di scooter.



N
NEW



N
NEW

YASUNI ECO

017848	*MINARELLI HORIZONTAL
017849	*MINARELLI VERTICAL
017850	*PEUGEOT BUXY 50 ('98)
017851	*GILERA DNA

MOTEUR MOTORE

POT D'ÉCHAPPEMENT 50CC A BOITE MARMITTA 50CC A MARCE

> YASUNI CROSS ML

YASUNI

Le Cross ML est l'équivalent Cross du R1 de route.
Il fournit une puissance notable aux motos de série sans avoir besoin de préparations supplémentaires.

Il Cross/Enduro ML è l'equivalente del R1 stradale.
Fornisce un notevole incremento alle moto di serie senza avere bisogno di preparazioni supplementari.



YASUNI CROSS ML EMBOUT MAX NOIR
017842B *AM6 - BETA RR-T - YAMAHA DT-50 -
PEUGEOT XPS-XP6 - RIEJU MRT

YASUNI CROSS ML EMBOUT MAX ALU BROSE
017842X *AM6 - BETA RR-T - YAMAHA DT-50 -
PEUGEOT XPS-XP6 - RIEJU MRT

> YASUNI HM

YASUNI

Le Cross HM est l'équivalent Cross du SPR 3 et du HMR2 de route avec plusieurs adaptations possibles sur de nombreux modèles de moto.

Il permet de mieux optimiser les performances du moteur de série ou préparé.

Avec certificat d'homologation.

Il Cross/Enduro HM è l'equivalente del SPR 3 e del HMR2 stradale con vari adattamenti possibili su di numerosi modelli di moto. Permette di ottimizzare al meglio le prestazioni del motore di serie o preparato. Con certificato di omologazione.



YASUNI CROSS EMBOUT MAX ALU BROSE
017843B *DERBI SENDA - DRD RACING

YASUNI CROSS EMBOUT MAX NOIR
017843X *DERBI SENDA - DRD RACING

MOTEUR MOTORE

POT D'ÉCHAPPEMENT 50CC A BOITE MARMITTA 50CC A MARCE

> YASUNI CROSS

YASUNI

Échappement offrant des bonnes prestations, pouvant être monté sur de nombreux modèles de moto. Il permet de mieux optimiser les performances du moteur de série. Son design est de type classique.

Scarico che offre delle buone prestazioni, può essere montato su numerosi modelli di moto. Permette di ottimizzare meglio le prestazioni del motore di serie. Il suo design è di tipo classico.



YASUNI CROSS EMBOUT CARBON / KEVLAR
017807 *DERBI SENDA R-SM 2000/LOBITO/ZULU

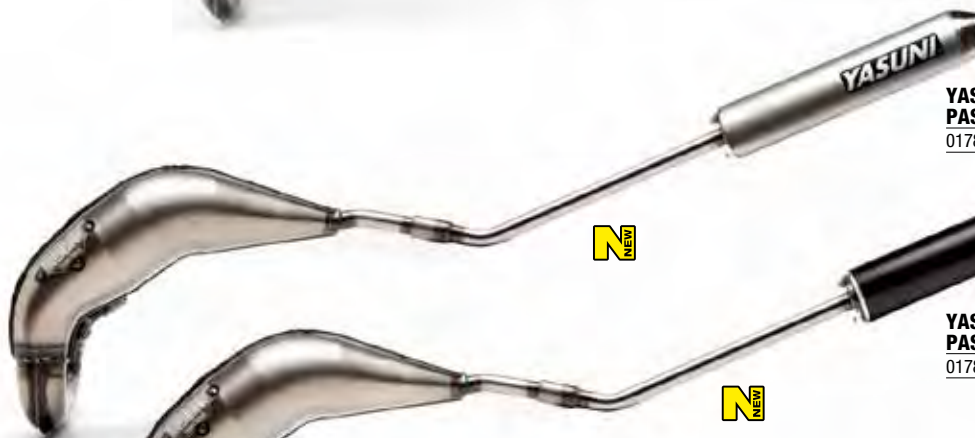

**YASUNI CROSS EMBOUT MAX ALU BROSSE
PASSAGE HAUT-GAUCHE**
017841X *DERBI SENDA - DRD RACING

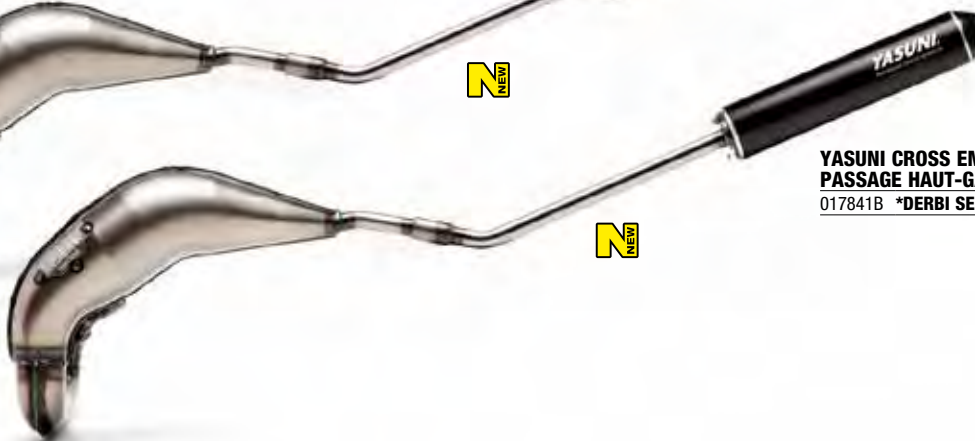

**YASUNI CROSS EMBOUT MAX NOIR
PASSAGE HAUT-GAUCHE**
017841B *DERBI SENDA - DRD RACING

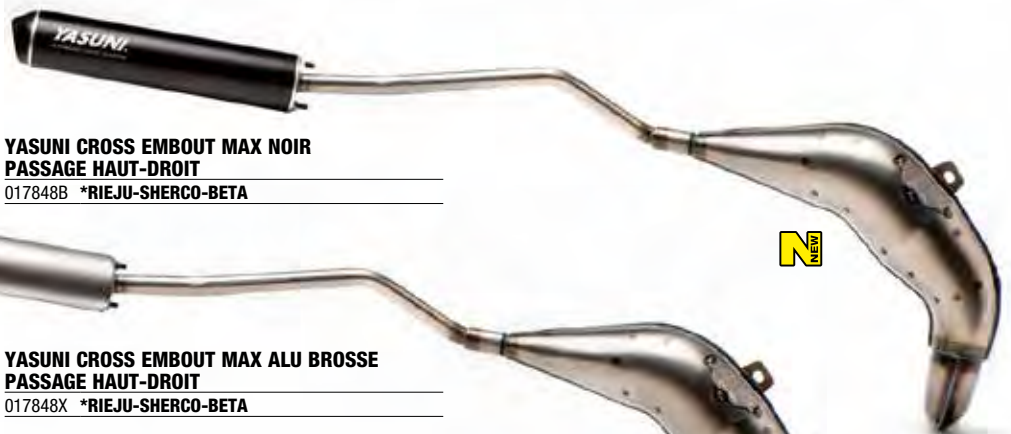

**YASUNI CROSS EMBOUT MAX NOIR
PASSAGE HAUT-DROIT**
017848B *RIEJU-SHERCO-BETA

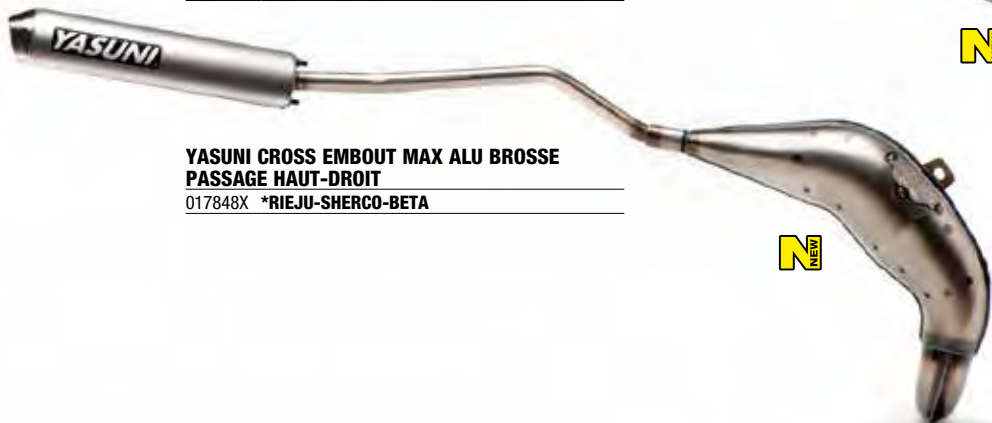

**YASUNI CROSS EMBOUT MAX ALU BROSSE
PASSAGE HAUT-DROIT**
017848X *RIEJU-SHERCO-BETA

* Adaptable
* Adattabile

Les références du constructeur sont seulement indicatives et n'impliquent pas que les pièces de rechange viennent du constructeur.
I codici di riferimento originali sono indicativi e non implicano che i ricambi provengano necessariamente dalla stessa fabbrica del costruttore.

MOTEUR MOTORE

POT D'ÉCHAPPEMENT 50CC A BOITE MARMITTA 50CC A MARCE

> YASUNI R1

YASUNI

Le R1 est un échappement développé pour les motos de série qui fournit une grande puissance sans avoir besoin de préparations supplémentaires. Avec certificat d'homologation.
Diamètre de sortie: 25 mm.

L' R1 è uno scarico sviluppato per le moto di serie che fornisce un grande incremento senza avere bisogno di preparazioni supplementari. Con certificato di omologazione.
Diametro di uscita: 25 mm.



YASUNI R1 EMBOUT CARBON / KEVLAR

017835 *APRILIA RS 50



YASUNI R1 EMBOUT MAX ALU NOIR Ø25MM

017844B *AM6 - BETA RR-T - YAMAHA DT-50 -
PEUGEOT XPS-XP6 - RIEJU MRT

017845B *APRILIA RS 50 - RIEJU RS2 MATRIX -
YAMAHA TZR50 - MBK XPOWER



YASUNI R1 EMBOUT MAX ALU BROSSE Ø25MM

017844X *AM6 - BETA RR-T - YAMAHA DT-50 -
PEUGEOT XPS-XP6 - RIEJU MRT

017845X *APRILIA RS 50 - RIEJU RS2 MATRIX -
YAMAHA TZR50 - MBK XPOWER

MOTEUR MOTORE

POT D'ÉCHAPPEMENT 50CC A BOITE MARMITTA 50CC A MARCE

> YASUNI R2

YASUNI

S'agit d'un échappement pour cylindres de 50 cc, mais prévu pour offrir les meilleures performances avec les préparations, y compris les modifications des cylindres pour passer à 70 cc. Diamètre de sortie : 28 mm.

Si tratta di uno scarico per cilindri di 50 cc, ma previsto per offrire le migliori prestazioni con le preparazioni, ivi compreso le modifiche per passare a 70 cc. Diametro di uscita: 28 mm.

YASUNI R2 EMBOUT MAX ALU NOIR Ø28MM

017846B *AM6 - BETA RR-T - YAMAHA DT-50 -
PEUGEOT XPS-XP6 - RIEJU MRT

017847B *APRILIA RS 50 - RIEJU RS2 MATRIX -
YAMAHA TZR50 - MBK XPOWER

YASUNI R2 EMBOUT MAX ALU BROSSE Ø28MM

017846X *AM6 - BETA RR-T - YAMAHA DT-50 -
PEUGEOT XPS-XP6 - RIEJU MRT

017847X *APRILIA RS 50 - RIEJU RS2 MATRIX -
YAMAHA TZR50 - MBK XPOWER

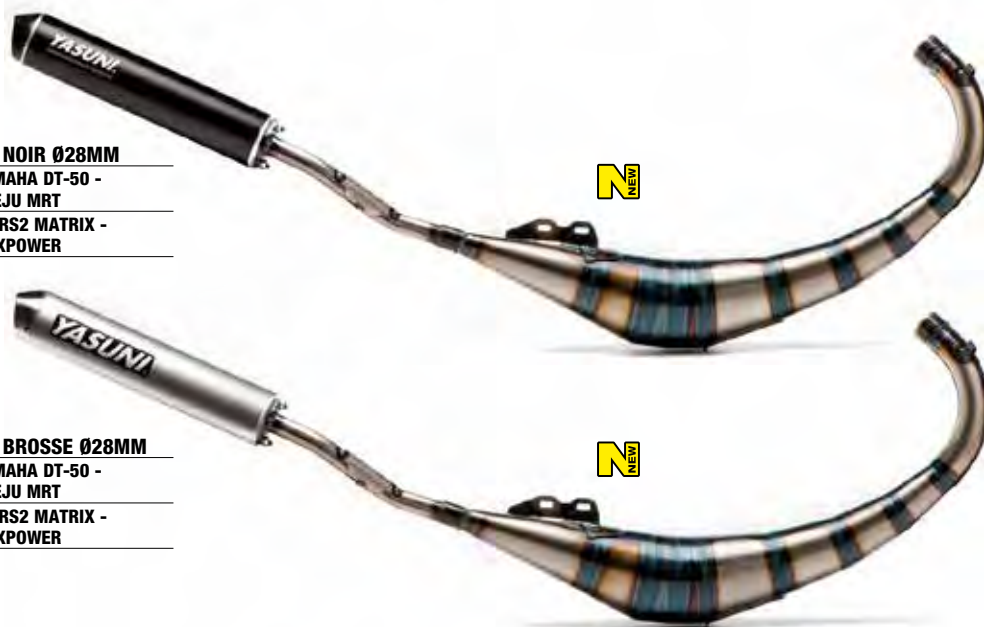

> YASUNI

YASUNI



Pot d'échappement aux lignes sportives et modernes qui offrent jusqu'à 10% d'augmentation en puissance, un plus grand couple moteur et le poids le plus léger du marché.

Silenziatote con linee sportive e moderne che dona fino al 10% di incremento, con una coppia motore maggiore ed il peso più leggero esistente sul mercato.

YASUNI MAXISCOOTER TITANIUM LOOK

017815 *YAMAHA XMAX 125

YASUNI MAXISCOOTER BLACK CARBON

017838C *YAMAHA 530 TMAX

017815C *YAMAHA XMAX 125

YASUNI MAXISCOOTER BLACK EDITION

017839B *HONDA 125 FORZA

017815B *YAMAHA XMAX 125



* Adaptable
* Adattabile

Les références du constructeur sont seulement indicatives et n'impliquent pas que les pièces de rechange viennent du constructeur.
I codici di riferimento originali sono indicativi e non implicano che i ricambi provengano necessariamente dalla stessa fabbrica del costruttore.

MOTEUR MOTORE

POT D'ÉCHAPPEMENT MAXI SCOOT MARMITTA MAXI SCOOTER

> POT D'ÉCHAPPEMENT CITY MARMITTA CITY



Pot échappement carbone NHRC HC-0116C adaptable city 1 et 2 non homologué.
Chicane amovible.

MARMITTA carbonio NHRC HC-0116C adattabile city 1 e 2 non omologato.
Briga amovibile.

EURO4

EPI



HC-0116C PASSAGE BAS CARBONE

970911L *CITY 12 TUNING NON HOMOLOGUÉ

LIVRÉ AVEC KIT DE FIXATION

CON KIT DI FISSAGGIO



N-0130C PASSAGE HAUT CARBONE

*CITY 12 TUNING NON HOMOLOGUÉ

LIVRÉ AVEC KIT DE FIXATION

CON KIT DI FISSAGGIO

970911J



N-0130C PASSAGE HAUT

*CITY 12 TUNING NON HOMOLOGUÉ

LIVRÉ AVEC KIT DE FIXATION

CON KIT DI FISSAGGIO

970910Z CHROME



MOTEUR MOTORE POT D'ÉCHAPPEMENT MARMITTA

➤ ACCESSOIRES T-MAX 500/530 & X-MAX



EMBOU ECHAPPEMENT FONDELLO MARMITTA

***YAMAHA T-MAX 2008-2011**

380000 NOIR MAT NERO OPACO
380000A GRIS MAT GRIGIO OPACO
380000B NOIR BRILLANT NERO BRILLANTE
380000C CARBONE CARBONIO



EMBOU ECHAPPEMENT FONDELLO MARMITTA

***YAMAHA T-MAX 500 2007-2011**

368001P ANTHRACITE GRIGIO
368001Q CARBON STYLE CARBONIO



EMBOU ECHAPPEMENT FONDELLO MARMITTA

***YAMAHA *X-MAX / XCITY / MAJESTY 125**

368001B



EMBOU ECHAPPEMENT INFERIEUR PROTEZIONE COLLETTORE SCARICO

***YAMAHA T-MAX 500 530 2008-2016**

380000I NOIR MAT NERO OPACO
368000Y CARBON STYLE CARBONIO
368000X CHROME CROMO



PROTECTION ECHAPPEMENT INFERIEUR PROTEZIONE COLLETTORE SCARICO

***YAMAHA T-MAX 500 2001-2007**

368000Q CARBON STYLE CARBONIO
368000P CHROME CROMO



COUVERCLE SUPERIEUR ECHAPPEMENT PROTEZIONE COLLETTORE SCARICO

***YAMAHA T-MAX 500 2008-2012**

369000A CARBON STYLE CARBONIO



PROTECTION ECHAPPEMENT PROTEZIONE MARMITTA

***YAMAHA T-MAX 500 2001-2006**

3680000 CARBON STYLE CARBONIO
368000N CHROME CROMO
368001M BRONZE BRONZO



PROTECTION ECHAPPEMENT FONDELLO MARMITTA

***X-MAX / XCITY / MAJESTY 125 250 / VERSITY 300**

368001 CHROME CROMO
368001A CARBON STYLE CARBONIO



PROTECTION ECHAPPEMENT PROTEZIONE MARMITTA

***YAMAHA T-MAX 500 / 530 2008-2016**

380000H NOIR MAT NERO OPACO
368000T SILVER ARGENTO
368000U CHROME CROMO
368000V ANTHRACITE BRONZE GRIGIO BRONZO
368000W CARBON STYLE CARBONIO



EMBOU ECHAPPEMENT FONDELLO MARMITTA

***YAMAHA T-MAX 530 2007-2013**

368001I ANTHRACITE GRIGIO
368001J CARBON STYLE CARBONIO



PROTECTION ECHAPPEMENT PROTEZIONE MARMITTA

***YAMAHA T-MAX 530 2007-2013**

368001C ANTHRACITE BRONZE GRIGIO BRONZO
368001D CARBON STYLE CARBONIO
380000I NOIR MAT NERO OPACO

MOTEUR MOTORE POT D'ÉCHAPPEMENT EXHAUST

> ACCESSOIRES ACCESSORI MAJESTY 400 07-2010



PROTECTION ECHAPPEMENT PROTEZIONE MARMITTA

***YAMAHA MAJESTY 400 2004-2006** entraxe 268mm (1)
380000K *MAJESTY 400 2004-2006 SILVER
380000J *MAJESTY 400 2004-2006 SILVER MAT
***YAMAHA MAJESTY 400 2007-2010** entraxe 310mm (2)
370000M NOIRE NERO
370000N CHROME CROMO
370000O CARBON STYLE CARBONIO



EMBOU ECHAPPEMENT FONDELLO MARMITTA

***YAMAHA TMAX 500 / MAJESTY 400 2001-2006**
3680010 CARBONE CARBONIO
368001N GRIS GRIGIO



EMBOU ECHAPPEMENT FONDELLO MARMITTA

***YAMAHA TMAX 500 / MAJESTY 400 2001-2006**
380000D NOIR MAT NERO OPACO
380000G CARBONE CARBONIO
380000E GRIS MAT GRIGIO OPACO
380000F NOIR BRILLANT NERO BRILLANTE

> ACCESSOIRES ACCESSORI HONDA SH 300



PROTECTION ECHAPPEMENT PROTEZIONE MARMITTA

***HONDA SH 300 2007-2013**
368001E A PEINDRE DA VERNICE
368001F ARGENT ARGENTO
368001G NOIR METAL NERO METAL
368001H CARBON STYLE CARBONIO



EMBOU ECHAPPEMENT FONDELLO MARMITTA

***HONDA SH 300 2007-2013**
368001K A PEINDRE DA VERNICE

> ACCESSOIRES ACCESSORI



REDUCTEUR ECHAPPEMENT DEPRESSION RIDUTTORE

***POT AM6**
019949A Ø28/25



CARTOUCHE SILENZIATORE

017181 ALU ALLUMINIO



ADAPT. CARTOUCHE R-1 ADAPT. SILENZIATORE R-1

017350 Ø 18
017351 Ø 20
017352 Ø 22



LAIN DE CERAMIQUE LANA CERAMICA

019970 20 X 25 50CC
019971 30 X 25 50CC
017515B 30 X 61 X 1,5 125CC
S701903 30 X 25



RESSORT DE POT MOLLA SILENZIATORE

019960 COURT 44 MM
019960A LONG 67 MM



VIS D'ÉCHAPPEMENT VITE MARMITTA

170500 *PEUGEOT 103 (1)
170510 *BOOSTER (2)



COLLIER POUR CARTOUCHE COLLARE PER SILENZIATORE

080096 *SCOOTER Ø60



32 RÉFÉRENCES ADAPTABLES SH 125/150 2005-2008



MOTEUR MOTORE CYLINDRE ALUMINIUM CILINDRO COMPLETO

> SCOOTER

TNT
Original



*BOOSTER/STUNT

032000		CYLINDRE COMPLET CILINDRO COMPLETO
050341	🔧	Ø40
050342	🔧	Ø40 PISTON PLAT FLAT PISTON
060004	🔧	Ø40 X 1,2



*BUXY/SPEEDFIGHT

032001		CYLINDRE COMPLET CILINDRO COMPLETO
032001A	🔧	Ø40
032001B	🔧	Ø40 X 1,2



*NITRO AEROX

032050		CYLINDRE COMPLET + CULASSE CILINDRO COMPLETO + TESTA
050341	🔧	Ø40
060004	🔧	Ø40 X 1,2



*OVETTO/SR MINARELLI

032002		CYLINDRE COMPLET CILINDRO COMPLETO
050341	🔧	Ø40
060004	🔧	Ø40 X 1,2



*TYPHOON/STALKER/ET2/LX2

032003		CYLINDRE COMPLET CILINDRO COMPLETO
032003A	🔧	Ø40
032003B	🔧	Ø40 X 1,2

> CYCLO CICLOMOTORE

TNT
Original



*PEUGEOT 103

032100		CYLINDRE COMPLET CILINDRO COMPLETO
051610	🔧	Ø40 "A"
051611	🔧	Ø40 "B"
060100	🔧	Ø40



*MBK 51

032101		CYLINDRE COMPLET CILINDRO COMPLETO
050800	🔧	Ø39 MBK 40/50/88/89/51 CDEFG
060105	🔧	Ø39
071801	🔧	Ø39



*CIAO Ø10

032122		CYLINDRE COMPLET CILINDRO COMPLETO
060105	🔧	Ø39



CULASSE *PEUGEOT 103

038506		AVEC DECOMPRESSEUR CON DECOMPRESSOR
--------	--	-------------------------------------



*SOLEX

S56496		CYLINDRE SEUL UNICAMENTE CILINDRO
S22274	🔧	Ø39,5
S95172	🔧	Ø39,5
S7644	🔧	Ø39,5
S7645	🔧	Ø39,5

MOTEUR MOTORE CYLINDRE ALUMINIUM CILINDRO ALLUMINIO

➤ 50CC A BOITE 50CC A MARCE

TNT
Original



*MINARELLI AM6

032065		CYLINDRE COMPLET CILINDRO COMPLETO
032065A	🔧	Ø40
032065B	🔧	Ø40 X 1,2



*CPI SUPERMOTO

032062		CYLINDRE COMPLET + CULASSE CILINDRO COMPLETO + TESTA
032062A	🔧	Ø40
071821	🔧	Ø40



*DERBI SENDA 2006 > EURO 3

032061		CYLINDRE COMPLET + CULASSE CILINDRO COMPLETO + TESTA
052305	🔧	Ø40
061405	🔧	Ø40



*DERBI SENDA EURO 2

032060		CYLINDRE COMPLET + CULASSE CILINDRO COMPLETO + TESTA
032060A	🔧	Ø40
032060B	🔧	Ø40
032060C	🔧	Ø40



093097	*DERBI SENDA	(1)
093097A	*MINARELLI AM6	

➤ CYLINDRE FONTE CILINDRO GHISA
➤ SCOOTER

TNT
Original



*MINARELLI Vert. BOOSTER/BW'S

030300		CYLINDRE COMPLET CILINDRO COMPLETO
030300A		BOITE X12 CYL.
050341	🔧	Ø40 X 1,2
050342	🔧	Ø40 X 1,2 PLAT FLAT
060004	🔧	Ø40 X 1,2 NEW
060005	🔧	Ø40 X 1,5 OLD
071803	🔧	Ø40



*PEUGEOT SCOOTER BUXY

030301		CYLINDRE COMPLET CILINDRO COMPLETO
051610	🔧	Ø40 "A"
051611	🔧	Ø40 "B"
060100	🔧	Ø40
071804	🔧	Ø40



*SPEEDFIGHT H20

030301A		CYLINDRE COMPLET CILINDRO COMPLETO
051610	🔧	Ø40 "A"
051611	🔧	Ø40 "B"
060100	🔧	Ø40
071811	🔧	Ø40

MOTEUR MOTORE CYLINDRE FONTE CILINDRO GHISA

> SCOOTER



*PIAGGIO SCOOTER TYPHOON

030302		CYLINDRE COMPLET CILINDRO COMPLETO
050343	☒	Ø40
060007	☒	Ø40
071805	☒	Ø40



*MINARELLI Horiz. OVETTO/NEOS

030305		CYLINDRE COMPLET CILINDRO COMPLETO
030305A		BOITE X12 CYL.
050341	☒	Ø40
060004	☒	Ø40 X 1,2
071808	☒	Ø40



*PIAGGIO SCOOTER H20 NRG/NTT

030306	1	NEW CYL. COMPLET CILINDRO COMPLETO
030308		OLD CYL. COMPLET CILINDRO COMPLETO
050343	☒	Ø40
060007	☒	Ø40
071806	☒	Ø40



*KYMCO/AGILITY50/SCOOTER CHINOIS 4T GY6

030317		CYLINDRE COMPLET
030317D		X 12 CYLINDRES X 12 CILINDRI
050353	☒	Ø40
071812	☒	Ø40



*KYMCO AGILITY / SPACER 2T

030320		CYLINDRE COMPLET CILINDRO COMPLETO
050361	☒	Ø40
071813A	☒	Ø40



*MINARELLI HORIZ. H20 NITRO/AEROX

030307		CYLINDRE COMPLET CILINDRO COMPLETO
050341	☒	Ø40
060004	☒	Ø40 X 1,2
071807	☒	Ø40



*CPI EURO 2

030313		CYLINDRE COMPLET CILINDRO COMPLETO
050350	☒	Ø40 Ø12
060005	☒	Ø40 X 1,5
071808	☒	Ø40



*PEUGEOT SCOOTER LUDIX

030315		CYLINDRE COMPLET CILINDRO COMPLETO
051610	☒	Ø40 "A"
051611	☒	Ø40 "B"
060100	☒	Ø40
071913	☒	Ø40



*LUDIX H20

030315A		CYLINDRE COMPLET CILINDRO COMPLETO
051610	☒	Ø40 "A"
051611	☒	Ø40 "B"
060100	☒	Ø40
071913A	☒	Ø40



*SYM ORBIT / JET EURO X 2T

030319		CYLINDRE COMPLET CILINDRO COMPLETO
050361	☒	
071813	☒	



*SYM 4T / TWEET-VIVACITY-SPEEDFIGHT 4T

030321		CYLINDRE COMPLET CILINDRO COMPLETO
050362	☒	Ø40
071814	☒	Ø40



*HONDA SCOOTER BALI SCOOPY X8R

030314		CYLINDRE COMPLET CILINDRO COMPLETO
050340	☒	Ø39
061415	☒	Ø39
071912	☒	Ø39

MOTEUR MOTORE CYLINDRE FONTE CILINDRO GHISA

> SCOOTER



*TGB / SUZUKI KATANA / MORINI 2T

030323		CYLINDRE COMPLET CILINDRO COMPLETO
050364	☒	Ø40
071813B	☒	Ø40



*DAX / CITY / SKYTEAM 50CC 4T

030318		CYLINDRE COMPLET MOTEUR 139FMB CILINDRO COMPLETO
050360	☒	Ø39
071812A	☒	



*FUNNY GAS 4T GY6 80CC Ø47MM

030317B		CYLINDRE COMPLET CILINDRO COMPLETO
---------	--	---------------------------------------



*CPI / KEEWAY / GENERIC D.40 Ø12 EURO 3 BRIDE D ECHAPPEMENT 93°

030324		CYLINDRE COMPLET CILINDRO COMPLETO
050350	☒	Ø40 AXE Ø12
071808	☒	Ø40



*PEUGEOT KISBEE / DJANGO 50CC 4 TEMPS PISTON AXE DE 10

030317E		CYLINDRE COMPLET CILINDRO COMPLETO
050353A	☒	Ø40 AXE Ø10
071812	☒	Ø40



*YAMAHA AEROX / OVETTO 50CC 4T 3 SOUPAPES

030325		CYLINDRE COMPLET CILINDRO COMPLETO
050353B	☒	Ø40
	☒	Ø40 X 1,2



*PIAGGIO 50CC 4T FLY / VESPA LX / S / SPRINT / PRIMAVERA MOTEUR 4 SOUPAPES MOTORE A 4 VALVOLE

030302A		CYLINDRE COMPLET CILINDRO COMPLETO
050343A	☒	Ø40
	☒	Ø40



*PIAGGIO 50CC 4T ZIP / FLY / LIBERTY / VESPA ET4 MOTEUR 2 SOUPAPES MOTORE A 2 VALVOLE

030302B		CYLINDRE COMPLET CILINDRO COMPLETO
050343B	☒	Ø40
	☒	Ø40



*SUZUKI KATANA LC / APRILIA SR 2001 50 2TPS

030323A		CYLINDRE COMPLET CILINDRO COMPLETO
	☒	Ø40
	☒	Ø40



CYLINDRE FONTE

IRON CYLINDER

*YAMAHA PW 50 2T

030322		CYLINDRE COMPLET CILINDRO COMPLETO
050363	☒	Ø40
	☒	Ø40
071808B	☒	Ø40



CYLINDRE FONTE

IRON CYLINDER

*YAMAHA PW 80 2TPS

030322A		CYLINDRE COMPLET CILINDRO COMPLETO
---------	--	---------------------------------------

* Adaptable
* Adattabile

Les références du constructeur sont seulement indicatives et n'impliquent pas que les pièces de rechange viennent du constructeur.
I codici di riferimento originali sono indicativi e non implicano che i ricambi provengano necessariamente dalla stessa fabbrica del costruttore.

MOTEUR MOTORE CYLINDRE FONTE CILINDRO GHISA

> MAXI SCOOTER

TNT
Original



***AGILITY 125CC GY6 152 QMJ**

030317A	CYLINDRE COMPLET CILINDRO COMPLETO
	Ø52,4



***AGILITY 150CC GY6 157 QMJ**

030317C	CYLINDRE COMPLET CILINDRO COMPLETO
	Ø57



***YAMAHA XMAX 125CC**

030316D	CYLINDRE COMPLET CILINDRO COMPLETO
053000	Ø52,4
071850J	



***YAMAHA XMAX / MAJESTY 250CC 1996-2003**

030316C	CYLINDRE COMPLET CILINDRO COMPLETO
	Ø69
0718500	



YAMAHA MAJESTY / VERSITY 300CC 1996 - 2003

030316F	CYLINDRE COMPLET CILINDRO COMPLETO
	Ø72,5



***MAJESTY 125**

032300	CYLINDRE COMPLET CILINDRO COMPLETO
053000C	



***CYGNUS 125**

030316	CYLINDRE COMPLET CILINDRO COMPLETO
--------	---------------------------------------



***HONDA SH / SWING / PANTHEON 125CC**

030316A	CYLINDRE COMPLET CILINDRO COMPLETO
053000A	Ø52,5
071850	



***HONDA SH / DYLAN / PANTHEON 150CC**

030316B	CYLINDRE COMPLET CILINDRO COMPLETO
053000B	Ø57,5
071850A	



***HONDA SH / PCX 150CC 2012**

030316H	CYLINDRE COMPLET CILINDRO COMPLETO
	Ø57,3



***HONDA SH / PCX 125CC 2012**

030316G	CYLINDRE COMPLET CILINDRO COMPLETO
	Ø52,4



***PIAGGIO LIBERTY / FLY / VESPA ET4 125CC**

030316E	CYLINDRE COMPLET CILINDRO COMPLETO
	Ø57

MOTORE MOTOR CILINDRO GHISA CILINDRO DE HIERRO

> MAXI SCOOTER

TNT
Original



***SYM 125CC 4TPS**

030317F	CYLINDRE COMPLET CILINDRO COMPLETO
---------	---------------------------------------



***SYM 150CC 4TPS**

030317G	CYLINDRE COMPLET CILINDRO COMPLETO
---------	---------------------------------------

> 50CC A BOITE 50CC A MARCE

TNT
Original



***DERBI SENDA 2006 > EURO 3**

030312	CYLINDRE COMPLET CILINDRO COMPLETO
052305	Ø40
061405	Ø40
071829	Ø40



***DERBI SENDA EURO 2**

030311	CYLINDRE COMPLET CILINDRO COMPLETO
052305	Ø40
061405	Ø40 X 1,2
071822	Ø40



***MINARELLI AM6 > 2000**

030310	CYLINDRE COMPLET CILINDRO COMPLETO
050349	Ø40,3
061411	Ø40 X 1,2
071820	Ø40



***DERBI SENDA 2006**

038617A Ø40



***DERBI SENDA 6 TROUS**

038617 Ø40



***MINARELLI AM6**

038618 Ø40



CALORSTAT

093620 *DERBI SENDA (1)
093620A *MINARELLI AM6

> MOTO

ORIGINAL PARTS
GPM
FOR MOTORCYCLE



***YAMAHA YBR / XT-R / DERBI SENDA**

030330	125CC	CYLINDRE COMPLET CILINDRO COMPLETO
030330A	150CC	CYLINDRE COMPLET CILINDRO COMPLETO



****SUZUKI GS / GN / DR / MASH / BULLIT**

030331	125CC	CYLINDRE COMPLET (MOTEUR TYPE 157FMI)
030331A	150CC	CYLINDRE COMPLET (MOTEUR TYPE 157FMI)

MOTEUR MOTORE CYLINDRE FONTE CILINDRO GHISA

> SCOOTER

CARENZI

Puissant et coupleux

- Cylindre fonte
- Piston aluminium bi-segments
- Puissant et coupleux ce cylindre est destiné au pilote recherchant plus de performance pour une utilisation de tous les jours

Potente e con ottima coppia motore

- Cilindro in ghisa
- Pistone in alluminio doppio segmento
- Potente e corposo, questo cilindro è per chi ricerca maggiori prestazioni per l'utilizzazione di tutti i giorni



*BOOSTER/STUNT

031000		CYLINDRE COMPLET CILINDRO COMPLETO
052000	☒	Ø40
060004	☒	Ø40
071803	☒	Ø40



*NITRO

031000F		CYLINDRE COMPLET CILINDRO COMPLETO
052000	☒	Ø40
060004	☒	Ø40 X 1,2
071807	☒	Ø40



*OVETTO

031000D		CYLINDRE COMPLET CILINDRO COMPLETO
052000	☒	Ø40
060004	☒	Ø40 X 1,5
071807	☒	Ø40



*CPI

031000J		CYLINDRE COMPLET CILINDRO COMPLETO
052006	☒	Ø40
060005	☒	Ø40
071808	☒	Ø40



*LUDIX

031000K		CYLINDRE COMPLET CILINDRO COMPLETO
052002	☒	Ø40
060100	☒	Ø40 X 1,2
071913	☒	Ø40



*SPEEDFIGHT LIQUIDE

031000B		CYLINDRE COMPLET CILINDRO COMPLETO
052002	☒	Ø40
060100	☒	Ø40 X 1,5
071811	☒	Ø40



*TREKKER/BUXY

031000A		CYLINDRE COMPLET CILINDRO COMPLETO
052001	☒	Ø40
060100	☒	Ø40
071804	☒	Ø40



*TYPHOON/STALKER

031000C		CYLINDRE COMPLET CILINDRO COMPLETO
052003	☒	Ø40
060007	☒	Ø40 X 1,2
071805	☒	Ø40

MOTEUR MOTORE CYLINDRE FONTE CILINDRO GHISA

> 50CC A BOITE 50CC A MARCE

CARENZI



*DERBI SENDA EURO 3

031000L		CYLINDRE COMPLET CILINDRO COMPLETO
052005	Ø40	
061405	Ø40	
071829	Ø40	



*DERBI SENDA EURO 2

031000H		CYLINDRE COMPLET CILINDRO COMPLETO
052005	Ø40	
061405	Ø40	
071822	Ø40	



*MINARELLI AM6

031000G		CYLINDRE COMPLET CILINDRO COMPLETO
052004	Ø40,3	
061411	Ø40	
071821	Ø40	



*DERBI SENDA EURO 3

038701B	Ø40	
---------	-----	--



*DERBI SENDA

038701A	Ø40	
---------	-----	--



*MINARELLI AM6

038701	Ø40	
--------	-----	--

> SCOOTER

parmakit



*SPEEDFIGHT

030500M		CYLINDRE COMPLET + CULASSE CILINDRO COMPLETO + TESTA
050355	Ø40	
060101	Ø40	
0719142	Ø40 CULASSE ORIGINE TESTA ORIGINALE	



*BUXY/TREKKER

030500B		CYLINDRE COMPLET + CULASSE CILINDRO COMPLETO + TESTA
050355	Ø40	
060101	Ø40	
071914B	Ø40 CULASSE ORIGINE TESTA ORIGINALE	



*LUDIX

0305000		CYLINDRE COMPLET + CULASSE CILINDRO COMPLETO + TESTA
050355	Ø40	
060101	Ø40	



*BOOSTER/STUNT

030500F		CYLINDRE COMPLET + CULASSE CILINDRO COMPLETO + TESTA
050357	Ø40	
060101	Ø40	
071914E	Ø40 CULASSE ORIGINE TESTA ORIGINALE	



*OVETTO

030500H		CYLINDRE COMPLET + CULASSE CILINDRO COMPLETO + TESTA
050357	Ø40	
060101	Ø40	
071914G	Ø40 CULASSE ORIGINE TESTA ORIGINALE	



*NITRO

030500J		CYLINDRE COMPLET + CULASSE CILINDRO COMPLETO + TESTA
050357	Ø40	
060101	Ø40	
071914I	Ø40 CULASSE ORIGINE TESTA ORIGINALE	

* Adaptable
* Adattabile

Les références du constructeur sont seulement indicatives et n'impliquent pas que les pièces de rechange viennent du constructeur.
I codici di riferimento originali sono indicativi e non implicano che i ricambi provengano necessariamente dalla stessa fabbrica del costruttore.

MOTEUR MOTORE CYLINDRE FONTE GRUPPI TERMICI GHISA

> SCOOTER

parmakit



*SPEEDFIGHT

030500N		CYLINDRE COMPLET + CULASSE CILINDRO COMPLETO + TESTA
050355	Ø40	
060101	Ø40	



*BUXY/TREKKER

030500C		CYLINDRE COMPLET + CULASSE CILINDRO COMPLETO + TESTA
050355	Ø40	
060101	Ø40	
071914B	Ø40	



*TYPHOON/STALKER

030500E		CYLINDRE COMPLET + CULASSE CILINDRO COMPLETO + TESTA
050355	Ø40	
060101	Ø40	
071914D	Ø40	



*BOOSTER/STUNT

030500G		CYLINDRE COMPLET + CULASSE CILINDRO COMPLETO + TESTA
050357	Ø40	
060101	Ø40	
071914F	Ø40	



*OVETTO

030500I		CYLINDRE COMPLET + CULASSE CILINDRO COMPLETO + TESTA
050357	Ø40	
060101	Ø40	
071914H	Ø40	



*NITRO

030500K		CYLINDRE COMPLET + CULASSE CILINDRO COMPLETO + TESTA
050357	Ø40	
060101	Ø40	
071914J	Ø40	



*KYMCO DINK AIR

030500L		CYLINDRE COMPLET + CULASSE CILINDRO COMPLETO + TESTA
050358	Ø40	
071914K	Ø40 CULASSE ORIGINE TESTA ORIGINALE	



*TYPHOON/STALKER

030500G		CYLINDRE COMPLET + CULASSE CILINDRO COMPLETO + TESTA
050355	Ø40	
060101	Ø40	
071914C	Ø40 CULASSE ORIGINE TESTA ORIGINALE	



parmakit

MOTEUR MOTORE CYLINDRE FONTE GRUPPI TERMICI GHISA

> 50CC A BOITE 50CC A MARCE



*DERBI SENDA EURO 2

030500		CYLINDRE COMPLET + CULASSE CILINDRO COMPLETO + TESTA
050401		Ø40
071914		Ø40



*MINARELLI AM6

030500A		CYLINDRE COMPLET + CULASSE CILINDRO COMPLETO + TESTA
050354D		Ø40
071914A		Ø40

> SCOOTER



*NITRO/AEROX

35584		CYLINDRE COMPLET + CULASSE CILINDRO COMPLETO + TESTA
35850		Ø40



IRON MAX

*BOOSTER

033006		CYLINDRE COMPLET CILINDRO COMPLETO
033006A		Ø40
033006C		Ø40
033006B		Ø40

IRON MAX

Visuel non disponible
Unavailable picture

*NITRO / AEROX

033009		CYLINDRE COMPLET + CULASSE CILINDRO COMPLETO + TESTA
--------	--	---

> 50CC A BOITE 50CC A MARCE



IRON MAX

*DERBI EURO 3

033008		CYLINDRE COMPLET + CULASSE CILINDRO COMPLETO + TESTA
033007A		Ø40
033006C		Ø40
071915E		Ø40



IRON MAX

*MINARELLI AM6

033007		CYLINDRE COMPLET + CULASSE CILINDRO COMPLETO + TESTA
033007A		Ø40
033006C		Ø40
033007B		Ø40

* Adaptable
* Adattabile

Les références du constructeur sont seulement indicatives et n'impliquent pas que les pièces de rechange viennent du constructeur.
I codici di riferimento originali sono indicativi e non implicano che i ricambi provengano necessariamente dalla stessa fabbrica del costruttore.



TOUS LES **ALLUMAGES MVT** PRÉSENTÉS DISPOSENT D'UNE SORTIE 12V POUR L'ÉCLAIRAGE

Millenium - Allumage rotor externe monobloc à avance variable analogique

Ref MVT	Ref ACSUD	Modèle	Ref MVT	Ref ACSUD	Modèle
EXT 100	180002	MBK 51/88	EXT 111	180010	Derbi Senda
EXT 101	180002	MBK 51 Kick	EXT 112	180009	AM6 (sauf Yam, MBK 2003)
EXT 102	180000	103 gros cône	EXT 113	180012	RS Matrix 2006
EXT 103	180001	103 cône électronique	EXT 114	180013	F10 F12 F15 Beta Ark
EXT 104	180004	103 12 volts CDI bleu	EXT 115	180014	Derbi GPR 2005
EXT 105	180011	Fox CDI Bleu	EXT 116	180015	Fox Wallaroo CDI Black
EXT 106	180005	BW's jusqu'à 2002	EXT 119	180016	BW's à partir de 2003
EXT 107	180008	Aerox jusqu'à 2002	EXT 120	180017	Aerox à partir de 2003
EXT 108	180006	Scot Peugeot (sauf Ludix, Jet-F)	EXT 121	180018	X-Limit TDR 2003
EXT 109	180007	Scot Piaggio	EXT 122	180019	X-Power TZR 2003
EXT 110	180006A	Ludix Jet Force	EXT 123	1800068	Scotter Keeway CPI

Prémium- Allumage rotor interne
à avance variable analogique

Ref MVT	Ref ACSUD	Ref Eprom	Modèle
Prem 01	180120	Eprom 1	MBK 51/88
Prem 02	180121	Eprom 2	103 gros cône
Prem 03	180122	Eprom 2	103 cône électronique
Prem 06	180123	Eprom 3	BW's/Aerox (Mina) jusqu'à 2002
Prem 08	180124	Eprom 2	Scot Peug sauf Ludix Jet-F
Prem 09	180125	Eprom 1	Scot Piaggio
Prem 10	180126	Eprom 4	Ludix Jet Force
Prem 11	180127	Eprom 6	Derbi Senda
Prem 12	180128	Eprom 6	AM6 sauf Yam/MBK 2003
Prem 19	180129	Eprom 5	BW's/Aerox (Mina) à partir de 2003
Prem 21	180130	Eprom 5	X-Limit TDR 2003
Prem 23	180131	Eprom 3	Scot Keeway CPI

Digital Direct - Allumage rotor
interne à avance variable digitale

Ref MVT	Ref ACSUD	Modèle
DD 01	180140K	MBK 51/88
DD 02	180140I	103 gros cône
DD 03	180140J	103 cône électronique
DD 06	180140	BW's/Aerox (Mina) jusqu'à 2002
DD 08	180140B	Scot Peug sauf Ludix Jet-F
DD 09	180140D	Scot Piaggio
DD 10	180140C	Ludix Jet Force
DD 11	180140E	Derbi Senda
DD 12	180140F	AM6 sauf Yam/MBK 2003
DD 19	180140A	BW's/Aerox (Mina) à partir de 2003
DD 21	180140G	X-Limit TDR 2003
DD 23	180140H	Scot Keeway CPI

MOTEUR MOTORE CULASSE TESTA

TNT
Original



***BOOSTER/STUNT**
038610



***BUXY/LUDIX**
038611



***LUDIX LIQUIDE**
038611A



***NITRO/APRILIA SR**
038615



***NRG**
038616 NOUVEAU MODELE



***TYPHOON/STALKER**
038614 NOUVEAU MODELE



***EVOLIS/APRILIA/OVETTO**
038612



***CPI SM / SX 50CC**
038618A OEM : 1210-1001

N
NEW



***GY6 50CC 4T 139QMB/A**
038700D COMPLETE



***GY6 125CC 4T 152QMI**
038700E COMPLETE

CARENZI



***BOOSTER/STUNT**
038700



OVETTO/CPI
038700A



***NITRO**
038700B



***TYPHOON/STALKER**
038700C

> PISTON PISTONE

TNT
Original



PISTON SCOOTER
050345 *PEUGEOT SC 50
050346 *PEUGEOT ST 50



CIRCLIP DE PISTON
050000 Ø 12
050001 Ø 10

* Adaptable
* Adattabile

Les références du constructeur sont seulement indicatives et n'impliquent pas que les pièces de rechange viennent du constructeur.
I codici di riferimento originali sono indicativi e non implicano che i ricambi provengano necessariamente dalla stessa fabbrica del costruttore.

MOTEUR MOTORE VILEBREQUINS ALBERO MOTORE

CARENZI



Vilebrequin renforcé Carenzi

- Masses pleines, pions d'équilibrage en acier.
- Renforcé et usiné dans un acier traité de haute qualité.
- Bielle polie marquée CARENZI, cage à aiguilles renforcée.
- Vitesse de rotation maximale 16000 tours/minute.
- Vilebrequin adaptée aux petites et moyennes configurations.

Albero motore rinforzato Carenzi Evolution

- Spalle piene, bilanciamento con pioli in acciaio rettificati.
- Rinforcato e fabbricato con trattamento acciaio di alta qualità.
- Biella lucidata marcata Carenzi, gabbia a rulli rinforzata.
- Equilibrio dinamico 16.000 giri / minuto.
- Albero motore adatto per medie configurazioni.

> SCOOTER

CARENZI



*APRILIA/NITRO 010
090931A



*APRILIA/NITRO 012
090932A



*BOOSTER
090933A



*BUXY/SPEEFIGHT
090937A



*TREKKER/SPEEFIGHT 2007
090937B



*TYPHOON
090939A

> 50CC A BOITE 50CC A MARCE

CARENZI



*MINARELLI 6V
090935A



*DERBI SENDA
090949A



*DERBI SENDA 2006 > euro 3
090949B

MOTEUR MOTORE VILEBREQUINS ALBERO MOTORE



Vilebrequin renforcé MVT

Au premier coup d'œil on s'aperçoit de la qualité des vilebrequins MVT, avec son équilibrage spécifique, ses 2 grosses masses d'équilibrage rouges et le logo MVT gravé sur la masse.

Réalisé en acier supérieur forgé puis cémenté et rectifié sur CN, équipé d'une bielle haute charge en acier forgé et poli, montée sur une cage à aiguilles argent haute vitesse.

Cet embiellage peut résister à de très hauts régimes moteur de 18.000 tr/min et peut encaisser de très grosses charges grâce à son maneton de 18 mm.

Albero motore rinforzato MVT

A prima vista si vede la qualità della biella MVT, con il suo specifico bilanciamento, le sue 2 grandi spalle d'equilibratura rosse con incisione del logo MVT. Realizzato in acciaio superiore forgiato, temprato e rettificato con CNC, dotato di biella in acciaio forgiato e lucidato, con gabbia a rulli ad alta velocità.

Questa biella può sopportare velocità molto elevate del motore, fino a 18.000 giri / min e può supportare carichi di coppia motore molto alti, grazie anche al suo occhio di 18 mm.

SCOOTER



*SCOOTER PEUGEOT AM
090980A



*SCOOTER PIAGGIO
090980B



*NITRO/AEROX
090980D



*NITRO/AEROX 012
090980E



*BOOSTER
090980F



*LUDIX/JET FORCE
090980H

5OCC A BOITE 5OCC A MARCE



*MINARELLI 6V
090980



*DERBI SENDA
090980C



*DERBI SENDA 2006 > euro 3
090980G

MOTEUR MOTORE VILEBREQUINS ALBERO MOTORE



Renforcé et de bonne qualité,
ce vilebrequin permet une légère amélioration des performances grâce à sa conception à masses pleines. Une solution peu coûteuse pour les petites et moyennes configurations.

Rinforzato e di ottima qualità,
questo albero motore permette un miglioramento delle prestazioni con il suo design spalle piene. Una soluzione sicura ed economica per le medie configurazioni.

SCOOTER



***NITRO/OVETTO**
090802A



***BOOSTER**
090803A



***SFERA/TYPHOON**
090804A



***PIAGGIO 50CC 4T D.20**
090804B OEM: 969428



***BUXY/ZENITH**
090805A



***TREKKER/SPEEFIGHT 2007**
090805B



***CPI**
090806A



***LUDIX**
090810



***KISBEE / DJANGO50 / SYM FIDDLE / ORBIT**
090850C 4TPS Ø10MM



* Adaptable
* Adattabile

Les références du constructeur sont seulement indicatives et n'impliquent pas que les pièces de rechange viennent du constructeur.
I codici di riferimento originali sono indicativi e non implicano che i ricambi provengano necessariamente dalla stessa fabbrica del costruttore.

MOTEUR MOTORE VILEBREQUINS ALBERO MOTORE

> SCOOTER

TNT
Original



***VESPA PK - PK XL 50**
090500 OEM : 224587



***VESPA PK 1982 - 1985**
090500A OEM : 123292



***KYMCO/AGILITY 50 / SCOOTER GY6 50CC 4T**
090850



***SCOOTER CHINOIS 50 GY6 1E40QMB Ø10MM**
090850B

> MAXI SCOOTER

TNT
Original



***HONDA SH 125 /150cc 4T**
090971 OEM: 13300-KGG-910



***YAMAHA MAJESTY 125CC 98-2005**
090972A OEM : 5DSE14000100



***YAMAHA XMAX 125CC**
090972 OEM: 1B9E14000000



***VESPA PX 125CC**
090500C OEM : 1331545



***VESPA PRIMAVERA ET3**
090500B OEM : 123296



***SCOOTERONE / GY6 125 4T**
090850A

MOTEUR MOTORE VILEBREQUINS ALBERO MOTORE

> 50CC A BOITE 50CC A MARCE

TNT
Original



*APRILIA RS 50 / AM6
090700A



*DERBI SENDA
090705A



*DERBI SENDA <2006 EURO 3
090705B

> CYCLO CLCLOMOTORE

TNT
Original



*PEUGEOT 103 ELECTRONIQUE SP
090600A



*MBK 51 NEW MODELE
090601A

> ROULEMENT CUSCINETTI E GUARNIZIONI

NTN



KIT ROULEMENTS NTN + JOINTS SPI

KIT CUSCINETTI

SCOOTER

*BUXY/TREKKER/SPEEDFIGHT	100006
*LUDIX	100009
*TYPHOON	100007
*BOOSTER/NITRO/OVETTO/CPI	100005

50CC A BOITE 50CC A MARCE

*DERBI SENDA	100008
*DERBI SENDA 2006	100008A
*MINARELLI AM6 TYPE ORIGINE	100010
*MINARELLI AM6 CARENZI/TNT RACING	100011
*MINARELLI AM6 JOINT SPY VITON	100014

CYCLO CICLOMOTORE

*PEUGEOT 103	100000
*MBK 51	100001

ROULEMENT EMBRAYAGE

CUSCINETTI FRIZIONE

*TYPHOON	6203 2RS	100661
*BOOSTER/STUNT/TREKKER/BUXY	6203 C3	100750
*BOOSTER/STUNT	6200 1RS	100650

ROULEMENT MOTEUR

CUSCINETTI MOTORE

*BOOSTER/STUNT/LUDIX	6204 JR2C4	100800
*BOOSTER/STUNT	6204 C3	100872
*TREKKER/SPEEDFIGHT/TYPHOON/NRG	SC04A47CS29	100870
*PIAGGIO/TYPHOON/GILERA	SC04A47CS29	
*MINARELLI	6303 C3	100876
*PEUGEOT SC 50	6004	100860
*PEUGEOT LUDIX/JET FORCE/SPEEDFIGHT 3	6204 TVH C4	
*CIAO	6202	100700
*PEUGEOT 103	6203 C3	100750
*PEUGEOT 103	6204 C4	100800
*MBK 51	6302 QR	100850
*DERBI SENDA	6204 TVH C4	
*AM6 type origine (pochette 2 joints)	6203 TVH C4	

> ROULEMENT CUSCINETTI E GUARNIZIONI

TPI
BEARINGS



N
NEW

KIT ROULEMENTS TPI + JOINTS SPI

KIT CUSCINETTI TPI + SERIE PARAOLI

*YAMAHA BOOSTER / NITRO / OVETTO / CPI	6204 TVH C4	100020
*PEUGEOT BUXY / SQUAB / TREKKER / TKR / VIVACITY / SPEEDFIGHT 1 ET 2	SC04A47CS29	100020A
*PIAGGIO TYPHOON / GILERA	SC04A47CS29	100020B
*PEUGEOT LUDIX / JET FORCE / SPEEDFIGHT 3	6204 TVH C4	100020E
*DERBI SENDA	6204 TVH C4	100020C
*AM6 TYPE ORIGINE	6303 TVH C4	100020D

MOTEUR MOTORE ROULEMENT CUSCINETTI E GUARNIZIONI

TNT
Original



CAGE AIGUILLE PISTON GABBIA RULLI

041209	12X16X13	*SCOOTER CPI ARGENT
041210	10X14X13	*BOOSTER/SR/PGO
041211	12X15X15	*BUXY/103/SENDA/AM6
041212	12X17X13	*TYPHOON
041215	12X17X14	*HONDA/KYMCO SCOOT 50 2T
S2906	13X16X14	*MBK 51
S54438	12X15X17,5	*PEUGEOT

SCOOTER

JOINT SPY PARAOLIO

042000	*BUXY / LUDIX 30X20X7
042001	*BUXY 25,5X15,6X7
042002	*TYPHOON 30X19X7
042003	*TYPHOON 28X18X7

JOINT SPY EMBIELLAGE ET BOITE PARAOLIO ALBERO MOTORE

040900	*BOOSTER/BWS/NITRO/AEROX (1)
040901	*TREKKER/SPEEDFIGHT X 4 JOINTS
040902	*TYPHOON POCLETTE DE 4 JOINTS
042000B	*GY6 50CC X 2 JOINTS
042000C	*GY6 125CC X 6 JOINTS

JOINT SPY EMBIELLAGE PARAOLIO ALBERO MOTORE

042005	*BOOSTER/BWS/NITRO/AEROX
040900B	*GY6 50CC 4TPS (POCHETTE DE 2 JOINTS)
040900C	*GY6 125CC 4TPS (POCHETTE DE 6 JOINTS)



50CC A BOITE 50CC A MARCE

040920	*AM6 X7
040920A	*AM6 X2
040921	*DERBI SENDA
040921A	*DERBI SENDA 2006>
040921B	*DERBI SENDA X2

CYCLO CICLOMOTORE

041010	*MBK 51 15X21X4,5
041000	*103 EMBRAYAGE 20X30X4,5 X10
041001	*103 ALLUMAGE 16X30X4,5 X10
040930	*PEUGEOT FOX X4

CARENZI



KIT ROULEMENT BOITE DE VITESSE KIT RULLI CAMBIO DE VELOCITA MOTEUR *MINARELLI AM6

100015



KIT ROULEMENT BOITE DE VITESSE KIT RULLI CAMBIO DE VELOCITA MOTEUR *BOOSTER / NITRO

100016



KIT ROULEMENT BOITE DE VITESSE KIT RULLI CAMBIO DE VELOCITA MOTEUR *DERBI

100017

CARENZI



KIT ROULEMENTS FAG CELERON RIVETÉ JOINT SPY VITON KIT CUSCINETTI FAG CELERON PARAOLIO VITON

SCOOTER

100012	*BOOSTER/NITRO/OVETTO/CPI
100013	*DERBI SENDA EURO 3



JOINT SPY EMBIELLAGE VITON RESSORT INOX PARAOLIO ALBERO MOTORE VITON

040900A	*BOOSTER / NG / OVETTO / STUNT
042000A	*LUDIX/SPEEDFIGHT3/JET FORCE X 2 JOINTS
040902A	*TYPHOON / NRG / RUNNER
040921C	*DERBI SENDA X2
040920C	*AM6 X2 (1)

JOINT SPY EMBIELLAGE PARAOLIO ALBERO MOTORE

S5765	*BUXY / SQUAB / TREKKER / SPEEDFIGHT
S43532	*SOLEX



CAGE AIGUILLE PISTON GABBIA RULLI

041210A	10X14X13	*BOOSTER/SR/PGO
041211A	12X15X15	*BUXY/103/SENDA/AM6
041212A	12X17X13	*TYPHOON
041213	12X16X16	*LUDIX
041214	12X17,5X15	*PEUGEOT

MOTEUR MOTORE JOINTS MOTEUR COMPLET GUARNIZIONI COMPLETO

TNT
Original



***BOOSTER**
072000

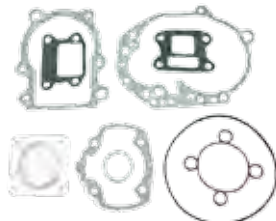

***BUXY / TREKKER / SPEEDFIGHT**
072002



***LUDIX**
072031



***MOTEUR GY6 50**
072032 139QMA/B



***NITRO / AEROX / OVETTO / NEOS / SR**
072001

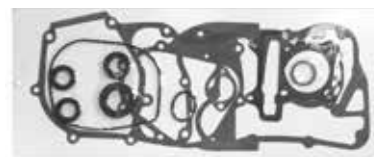

***MOTEUR GY6 125 4T**
072032A 152QMI



***MOTEUR GY6 50 2T**
072032B 1E40QMB



***DERBI SENDA EURO 2**
072020



***DERBI SENDA 2006 > EURO 3**
072021



***AM6**
072025



***MBK 51**
071801



***PEUGEOT 103**
071800



***PEUGEOT FOX**
072030



***CITY 125CC**
970910R



***CITY 50CC**
9709100

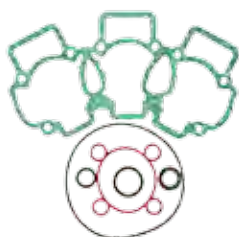

***RUNNER 50CC**
071850F



***BOOSTER / BWS / STUNT / SLIDER**
071803

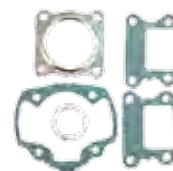

***BUXY**
071804

* Adaptable
* Adattabile

Les références du constructeur sont seulement indicatives et n'impliquent pas que les pièces de rechange viennent du constructeur.
I codici di riferimento originali sono indicativi e non implicano che i ricambi provengano necessariamente dalla stessa fabbrica del costruttore.

MOTEUR MOTORE JOINTS HAUT MOTEUR GUARNIZIONI GRUPPO TERMICO

TNT
Original



***HONDA SCOOPY**
071912



***KYMCO AGILITY 50CC / GY6 4T 50CC**
071812



***LUDIX**
071913



***LUDIX LC H20**
071913A

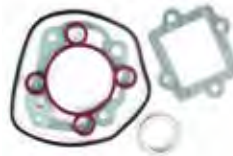

***NITRO / AEROX / APRILIA SR 50CC LC**
071807



***OVETTO**
071808

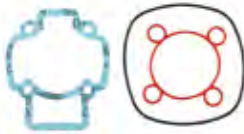

***PIAGGIO H20 NRG / RUNNER ANCIEN MODELE**
071806



***SPEEDFIGHT LC H20**
071811



***SYM JET 50CC 2T**
071813



***PIAGGIO 50CC ET4 00/05, ZIP 4T 00/06**
071850E



***PIAGGIO GILERA**
071804A



***PEUGEOT ST**
071809



***APRILIA SCARABEO 50**
071850L



***KYMCO DINK 50 AIR**
072032C



***KYMCO DINK 50 LC**
072032D



***KYMCO 50 2T**
071813A

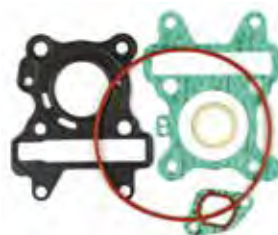

***OVETTO 50 4T**
071808A



***SOLEX**
S5616

MOTEUR MOTORE JOINTS HAUT MOTEUR GUARNIZIONI GRUPPO TERMICO



***SUZUKI RMX/SMX**
071850K

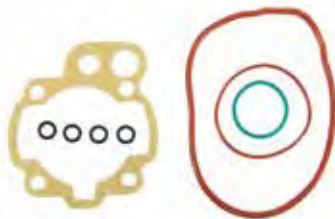

***AM6**
071820



***AM6 NM / CPI BOITE**
071821



***DERBI SENDA EURO**
071822



***DERBI SENDA 2006+ EURO 3**
071829



***DAX REPLICA 50 4T CITY / SKYTEAM**
071812A



***PEUGEOT 103 / FOX**
072030A



***PEUGEOT 103 H2O**
070701



***MBK 51 H2O**
070702



***YAMAHA TMAX 500 / 530**
078515C (EMBAYAGE) OEM : 5GJ-15451-00



***YAMAHA TMAX 500**
078515D OEM : 5GJ-17818-01

Visuel non disponible
Foto non disponibile



***YAMAHA XMAX 125**
0785151E OEM : 39D-15453-00



***YAMAHA NEOS 4T 08-2014**
072032H POCHETTE 24 PIECES



***YAMAHA XMAX 125 06-13**
072032G POCHETTE 29 PIECES



***YAMAHA XMAX 125**
071850J

* Adaptable
* Adattabile

Les références du constructeur sont seulement indicatives et n'impliquent pas que les pièces de rechange viennent du constructeur.
I codici di riferimento originali sono indicativi e non implicano che i ricambi provengano necessariamente dalla stessa fabbrica del costruttore.

MOTEUR MOTORE JOINTS HAUT MOTEUR GUARNIZIONI GRUPPO TERMICO

TNT
Original



***YAMAHA TMAX 500 01/02**
071850G

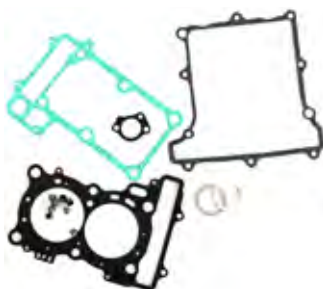

***YAMAHA TMAX 530 2012-16**
071850P POCHETTE 16 PIECES

N
NEW



***HONDA SH 125**
071850



***APRILIA SCARABEO 125**
071850N POCHETTE 8 PIECES



***HONDA 150**
071850A

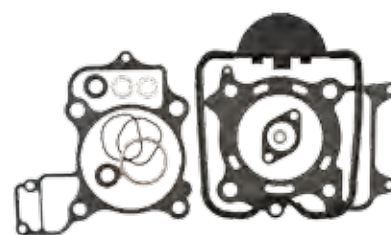

***HONDA SH 300**
071850H



***SUZUKI BURGMAN 125**
071850M

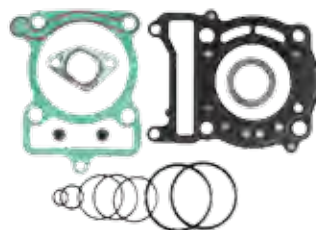

***SKYLINER 125 00/02**
071850C

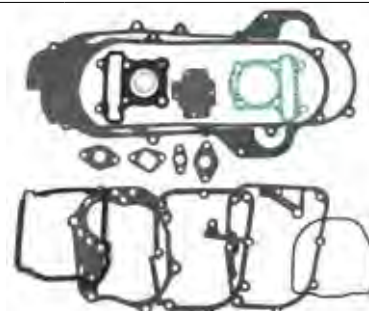

***SYM 50CC 4TPS MIO / ORBIT 2007 >**
072032E POCHETTE 15 PIECES



***VESPA ET4 / LIBERTY 125**
072032F POCHETTE 34 PIECES

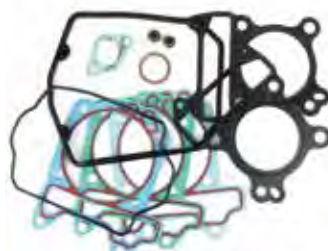

***LIBERTY 125/150**
071850B



***PIAGGIO X9 125**
071850D



***PIAGGIO 250 >2004**
071850I

MOTEUR MOTORE

JOINTS HAUT MOTEUR GUARNIZIONI GRUPPO TERMICO

parmakit



***BOOSTER / STUNT**
071914E CULASSE ORIGINE
TESTA ORIGINALE

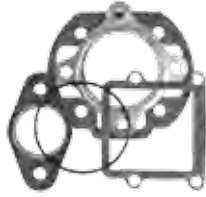

***BOOSTER / STUNT**
071914F CULASSE PARMAKIT
TESTA ORIGINALE

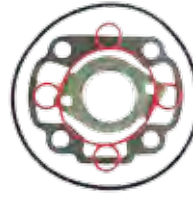

***NITRO**
071914I CULASSE ORIGINE
TESTA ORIGINALE

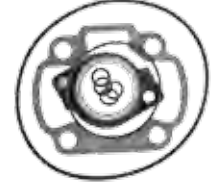

***NITRO**
071914J CULASSE PARMAKIT
TESTA ORIGINALE



***OVETTO**
071914G CULASSE ORIGINE
TESTA ORIGINALE



***OVETTO**
071914H CULASSE PARMAKIT
TESTA ORIGINALE



***TYPHOON**
071914C CULASSE ORIGINE
TESTA ORIGINALE



***TYPHOON**
071914D CULASSE PARMAKIT
TESTA ORIGINALE



***BUXY / TREKKER**
071914B



***SPEEDFIGHT**
071914L CULASSE ORIGINE
TESTA ORIGINALE



***AM6**
071914A



***KYMCO DINK AIR**
071914K



***DERBI SENDA EURO 2**
071914



MVT



***BOOSTER / STUNT**
071915



***LUDIX AIR**
071915A



***LUDIX H2O**
071915B



***NITRO**
071915C



***DERBI SENDA EURO 3**
033002C



***DERBI SENDA**
033000C

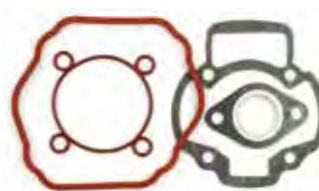

***PIAGGIO LC**
071915D

* Adaptable
* Adattabile

Les références du constructeur sont seulement indicatives et n'impliquent pas que les pièces de rechange viennent du constructeur.
I codici di riferimento originali sono indicativi e non implicano che i ricambi provengano necessariamente dalla stessa fabbrica del costruttore.

MOTEUR MOTORE JOINTS GUARNIZIONI

TNT
Original



JOINT DE POT
GUARNIZIONI MARMITTA

SCOOTER

078405	*MBK BOOSTER / NITRO	(1)
078406	*PEUGEOT SCOOTER	(2)
078407	UNIVERSEL UNIVERSAL	(3)
970918N	SCOOTER CHINOIS 50CC 4T	(4)

CYCLO CICLOMOTORE

041700	CUIVRE RAME	(5)
078401	*103 SPX-RCX / SCOOTER	(6)
078402	UNIVERSEL UNIVERSAL	(7)
078400	*PEUGEOT 103 / SCOOTER	(8)
S7649	*SOLEX	

MAXISCOOTER MAXISCOOTER

078408A	*PIAGGIO LEADER 125-200 LC (9) (32X38X30,5mm) OEM:846097/8263885	
078408B	*PIAGGIO 400-500 QUASAR (38X44X28mm) OEM:874946	

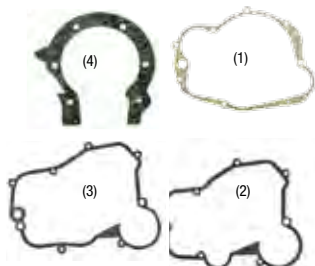

JOINT CARTER
GUARNIZIONI CARTER MORORE
50CC A BOITE 50CC A MARCE

078515	*AM6	(1)
078515A	*DERBI SENDA EURO 2	(2)
078515B	*DERBI SENDA EURO 3	(3)

CYCLO CICLOMOTORE

078500	*PEUGEOT 103 X10	(4)
--------	------------------	-----



FEUILLES A4 POUR JOINTS
FOGLI A4 GUARNIZIONI

070000	PAPIER CARTA 0,3 MM
070000A	PAPIER CRTA 0,5 MM
070000B	FIBRE FIBRA 0,5 MM
070000C	GRAPHIC + GRAFFITE 1,25 MM
070000D	CUIVRE RAME 0,35 MM
070000E	ALU. ALLUMINIO 0,35 MM

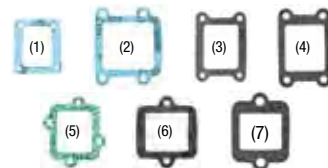

JOINT CLAPET X10
GUARNIZIONI PACCO LAMELLARE

076600	*PEUGEOT 103	(1)
076610	*BOOSTER	(2)
076610A	*DERBI	(3)
076610B	*AM6	(4)
076610C	*NITRO/OVETTO	(5)
076610D	*MOTEUR PEUGEOT	(6)
076610E	*MOTEUR PIAGGIO	(7)



CALE DE CYLINDRE ALU Ø0,5 MM
GUARNIZ. CILINDRO ALLUM. Ø0,5

SCOOTER

070007	*MINARELLI BOOSTER / STUNT (1)
070009	*PIAGGIO SCOOTER TYPHOON
070010	*MINARELLI Horiz. OVETTO / NEOS / CPI



JOINT POMPE A EAU
GUARNIZIONI POMPA ACQUA

078516	*MINARELLI AM6	(1)
078516A	*DERBI SENDA EURO 2	(2)
078516B	*DERBI SENDA EURO 3	(3)

CARTER MOTEUR CARTER MOTORE

TNT
Original



*MINARELLI VERT. BOOSTER / STUNT
093015



*MINARELLI HORIZ. NITRO / OVETTO
093016



*SPEEDFIGHT
093017



*PEUGEOT LUDIX / SPEEDFIGHT / TREKKER
093098



*MINARELLI
093095 *Vert. BOOSTER / STUNT (1)
093096 *Horiz. NITRO / OVETTO



093097 *DERBI SENDA (1)
093097A *MINARELLI AM6



JEU DE CARTERS AVEC ROULEMENTS
CARTER CON CUSCINETTI
093010 *MBK 51
090000 SILENT BLOCK MOTEUR



JEU DE CARTERS AVEC ROULEMENTS
CARTER CON CUSCINETTI
093000 *PEUGEOT 103



RESSORT MOTEUR
MOLLA MOTORE
092500 *PEUGEOT 103

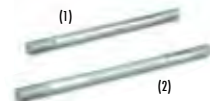

GOUJON DE CYLINDRE
VITI CILINDRO
093090 *PEUGEOT 103 (1)
093091 *MBK 51 (2)

MOTEUR MOTORE CARTER VARIATEUR CARTER VARIATORE



***MINARELLI Vert. BOOSTER / BW'S / STUNT / SLIDER**
289047 VENTILE CHROME CON PRESE ARIA CROMO



***MINARELLI Horiz. NITRO / AEROX / OVETTO / NEOS**
289068A VENTILE CHROME CON PRESE ARIA CROMO



***MINARELLI Vert. BOOSTER / BW'S / STUNT / SLIDER**
289050 STYLE CARBONE CARBONIO
289051 CHROME CROMO



***MINARELLI Horiz. NITRO / AEROX / OVETTO / NEOS**
289067 STYLE CARBONE CARBONIO
289068 CHROME CROMO



***SCOOTER CHINOIS 50 4T**
289040 R10"



***SCOOTER CHINOIS 50 4T**
289040A R12"



***T-MAX 500**
368000M VARIATEUR CARBONE
COPPIA COPERCHI FRIZIONE / VARIATORE CARBON LOOK
VARIATOR CARBONO



***T-MAX 500**
368000L TRANSMISSION CARBONE
COPERCHIO CATENA T MAX CARBON LOOK
ARRASTRE CARBONO

VIS VITI



VIS DE CARROSSERIE VITI CARENA

	ALU ALL	ALU ALL	ACIER CHR ACCIAIO CR
*BOOSTER/BW'S	171100	171104	171103
*NEXT		171107	171108
*NITRO			171123
*TYPHOON/NRG			171183



VIS DE CARTER VITI CARTER

		*BOOSTER	*TREKKER	*TYPHOON
ACIER CHR ACCIAIO CRO		171000	171010	171020
ALU BLEU ALLU BLU		171002	171012	171022
ALLU OR ALLU ORO		171003		
ALU ROUGE ALLU ROSSO		171004	171014	171024

* Adaptable
* Adattabile

Les références du constructeur sont seulement indicatives et n'impliquent pas que les pièces de rechange viennent du constructeur.
I codici di riferimento originali sono indicativi e non implicano che i ricambi provengano necessariamente dalla stessa fabbrica del costruttore.

MOTEUR MOTORE REFROIDISSEMENT RAFFREDDAMENTO

TNT
Original



***PEUGEOT
TREKKER / SPEEDFIGHT AC**
COIFFE DE CYLINDRE CUFFIA MOTORE
093599A



***MINARELLI Vert.
BOOSTER / STUNT**
COIFFE DE CYLINDRE CUFFIA MOTORE
093598



***MINARELLI Horiz.
OVETTO / MACH G AIR**
COIFFE DE CYLINDRE CUFFIA MOTORE
093599



TNT
Tuning



***MINARELLI VERT. BOOSTER/BW'S 2004**
093419 NOIR NERO
093419A CHROME CROMO



***MINARELLI VERT. BOOSTER/BW'S/STUNT**
< 2004
093501 NOIR NERO
093502 CHROME CROMO
093503 STYLE CARBONE CARBONIO
093507 BLANC BIANCO



***MINARELLI VERT. BOOSTER/BW'S/STUNT**
> 2004
093510 NOIR NERO
093510A CHROME CROMO
093510B STYLE CARBONE CARBONIO
093510E BLANC BIANCO



***MINARELLI HORIZ. OVETTO/NEOS/CPI**
093512 STYLE CARBONE CARBONIO
093513 CHROME CROMO
093514 BLANC BIANCO



***PIAGGIO TYPHOON**
093516 NOIR NERO
093517 CHROME CROMO
093519 STYLE CARBONE CARBONIO



***MINARELLI AIR**
287801 BLEU ANODISE ANODISED BLUE
287804 CHROME CROMO
287805 STYLE CARBONE CARBONIO
287806 BLANC BIANCO



***PEUGEOT LUDIX**
093500 NOIR NERO
093500A CHROME CROMO
093500B STYLE CARBONE CARBONIO
093500C BLANC BIANCO



SCOOTER
093410 NOIR NERO
093413 ROUGE ANODISE ROJO ANODIZADO
093414 CHROME CROMO
093415 STYLE CARBONE CARBONIO
093418 BLANC BIANCO



RADIATEUR DE DURITE
DISSIPATORE DI CALORE CIRCUITI H2O
094000 L.130 MM Ø 5MM

MOTEUR MOTORE

CARTER POMPE A EAU CARTER POMPA ACQUA

TNT
Tuning



***MINARELLI Horiz. H20**
***NITRO / AEROX**
289055 CHROME CROMO
289056 STYLE CARBONE CARBONIO



***PEUGEOT**
***SPEEDFIGHT**
289076B NOIR NERO

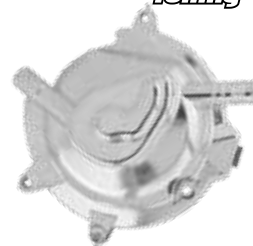

***PEUGEOT SPEEDFIGHT**
289076 CHROME CROMO

> POMPE A EAU POMPA ACQUA

> SCOOTER

TNT
Original



***BOOSTER 4T / OVETTO 4T**
093609E



***NITRO**
093610



***NRG / RUNNER**
093615

> MAXI SCOOTER

TNT
Original



***MAJESTY / SKYLINER 125**
093608



***YAMAHA MAJESTY 250CC**
093608A



***XMAX / XCITY 125**
093609D



***YAMAHA 500 T-MAX 5VU**
093630



***YAMAHA T-MAX 530**
093630A



***HONDA PCX 125**
093609G



***HONDA SH 125 / 150**
093609B



***HONDA SH 300**
093609F



***SUZUKI BURGMAN 125 / 250 / 400**
093609H



***HEXAGON / RUNNER 125 / 180**
093609



***X9 125 / 180 / 200 4T**
093609A OEM : 841333



***X9 125 Evo Euro 3**
093609C OEM : 872908

* Adaptable
* Adattabile

Les références du constructeur sont seulement indicatives et n'impliquent pas que les pièces de rechange viennent du constructeur.
I codici di riferimento originali sono indicativi e non implicano che i ricambi provengano necessariamente dalla stessa fabbrica del costruttore.

MOTEUR MOTORE POMPE A EAU RAFFREDDAMENTO

> 50CC A BOITE 50CC A MARCE

TNT
Original



*DERBI SENDA AM EURO 3
093607A



*DERBI SENDA
093607



*MINARELLI AM6
093616

> POMPE A EAU POMPA ACQUA

CARENZI

ADAPTABLE SUR TOUS SCOOTERS OU MECABOITE

- Débit 9L/min
- Corps de pompe aluminium taillé masse
- Gravure CARENZI laser
- Longueur 115mm, diamètre 36 mm
- Diamètre entrée/sortie 15 mm

ADATTABILE SU TUTTI GLI SCOOTER E MOTORI A MARCE

- Flusso 9L/min
- Corpo pompa in alluminio ricavato dal pieno
- Incisione CARENZI effettuata con laser
- Lunghezza 115mm, diametro 36 mm
- Diametro entrata/uscita 15 mm



**POMPE A EAU ELECTRIQUE CARENZI
ELECTRIC WATER PUMP**
093600A 12V



**KIT DURITE SILICONE DERBI EURO 3
KIT TUBI AL SILICONE DERBI EURO 3**
093800 VERT VERDE
093800A ORANGE ARANCIO
093800B JAUNE GIALLO
093800C ROUGE ROSSO
093800D BLEU BLU

> RADIATEUR RADIATORE

TNT
Original



**RADIATEUR
RADIATORE**
093600F *PIAGGIO MP3 400 /500CC
OEM : 653468



**RADIATEUR
RADIATORE**
093600C *PEUGEOT SPEEDFIGHT



**RADIATEUR
RADIATORE**
093600D *DERBI SENDA / GILERA / APRILIA
OEM: 00H03805011-AP8201666-
AP867123A5-86192R-
86193R-866995



**RADIATEUR
RADIATORE**
093600E *PIAGGIO ZIP LC / DNA / RUNNER
OEM : 299389

MOTEUR MOTORE

CARTER POMPE A HUILE RAFFREDDAMENTO

> CARTER POMPE A HUILE CARTER POMPA OLIO



*DERBI SENDA

289058	"LIGHTY" NOIR NERO
289058B	"LIGHTY" ROUGE ROSSO
289058C	"LIGHTY" STYLE CARBONE CARBONIO



*DERBI SENDA EURO 3

289079	NOIR NERO
289079A	BLEU ANODISE BLU ANODIZZATO
289079B	ROUGE ANODISE ROSSO ANODIZZATO
289079C	STYLE CARBONE CARBONIO



*AM6

289059B	"LIGHTY" STYLE CARBONE CARBONIO
---------	---------------------------------



BOUCHON D'HUILE OIL CAP

*BOOSTER / NITRO / CPI

171200	BLEU BLU
171202	ROUGE ROSSO
171203	CHROME CROMO



BOUCHON D'HUILE OIL CAP

*T-MAX 500

368000C	STYLE CARBONE CARBONIO
368000D	CHROME CROMO



POMPE A HUILE RÉGLABLE

pompa dell'olio regolabile

093600	*BOOSTER
--------	----------



OBTURATEUR DE POMPE A HUILE

OTTURATORE POMPA OLIO

*AM6

289059J	ARGENT ARGENTO
289059K	STYLE CARBONE CARBONIO



OBTURATEUR DE POMPE A HUILE

OTTURATORE POMPA OLIO

*DERBI SENDA EURO 3

289078J	ARGENT ARGENTO
289078K	STYLE CARBONE CARBONIO

> OBTURATEUR POMPE A HUILE OTTURATORE POMPA OLIO



*DERBI SENDA / AM6

OBTURATEUR DE POMPE A HUILE

OTTURATORE POMPA OLIO

289080	BLANC BIANCO
289080A	ROUGE ROSSO
289080B	BLEU BLU
289080C	NOIR NERO



MOTEUR MOTORE CARTER D'ALLUMAGE CARTER D'ACCENSIONE

TNT
Tuning



***DERBI SENDA EURO 3**
CARTER D'ALLUMAGE
CARTER D'ACCENSIONE
289078 NOIR NERO
289078A BLEU ANODISE BLU ANODIZZATO
289078B ROUGE ANODISE ROSSO ANODIZZATO
289078C STYLE CARBONE CARBONIO



***DERBI SENDA**
CARTER D'ALLUMAGE "LIGHTY"
CARTER D'ACCENSIONE "LIGHTY"
289069 NOIR NERO
289069A BLEU BLU
289069B ROUGE ROSSO
289069C STYLE CARBONE CARBONIO



***AM6 + CPI BOITE**
CARTER D'ALLUMAGE
CARTER D'ACCENSIONE
289070 BLEU METAL BLU METAL
289071 BLANC BIANCO
289075 STYLE CARBONE CARBONIO



easyboost



***MBK 51**
CARTER D'ALLUMAGE CARTER D'ACCENSIONE
289020 CHROME CROMO



COUVERCLE ALLUMAGE
CARTER D'ACCENSIONE
289100A *DERBI EURO2



COUVERCLE ALLUMAGE
CARTER D'ACCENSIONE
289100 *MBK NITRO / AEROX

> CACHE PIGNON COPRI PIGNONE

TNT
Tuning



***AM6**
CACHE PIGNON ALU
COPRI PIGNONE ALLUMINIO
289077J BLEU ANODISE BLU ANODIZZATO
289077K ROUGE ANODISE ROSSO ANODIZZATO
289077L ARGENT ARGENTO
289077M STYLE CARBONE CARBONIO



***AM6**
CACHE PIGNON
COPRI PIGNONE
289077 BLEU ANODISE BLU ANODIZZATO
289077A ROUGE ANODISE ROSSO ANODIZZATO
289077B CHROME CROMO
289077C STYLE CARBONE CARBONIO



***DERBI SENDA**
CARTER D'ALLUMAGE "LIGHTY" + CACHE PIGNON
CARTER D'ACCENSIONE "LIGHTY" + COPRI PIGNONE
289069J NOIR / BLEU BLACK / BLUE
289069K NOIR / ROUGE BLACK / RED
289069L NOIR / ARGENT BLACK / SILVER
289069M NOIR / STYLE CARBONE BLACK / CARBON STYLE



40 RÉFÉRENCES ADAPTABLES X-MAX 125 <2010





BOITE DE VITESSE MVT
GRUPPO RAPPORTI CAMBIO MVT
180800 *AM6 50/80 BT2



BOITE DE VITESSE MVT
GRUPPO RAPPORTI CAMBIO MVT
180800A *DERBI EURO2 50/80 BT1

DEMARREUR MESSA IN MOTO



DEMARREUR INGRANAGGI M/M
***BOOSTER / BW'S / NITRO / AEROX**

187193	EMBAYAGE FRIZIONE	(1)
187196	PIGNON INTERNE PIGNONE INTERNE	(2)
187197	RONDELLE PIGNON RONDELLA PIGNONE	(3)



COURONNE DEMARREUR
CORONA ACCENSIONE

187194B	*LUDIX
---------	--------



COURONNE DEMARREUR
CORONA ACCENSIONE

187194A	*PIAGGIO
---------	----------



***MINARELLI BOOSTER / NITRO**

090400	(1)
090401	(2)
090406	(3)
090407	(4)
090410	(5)
090410A	(6)
090410B	(7)
170310	8 M10 x 1,25



***PEUGEOT SCOOTER**

090419	MIKUNI 12,5 mm (1)
090420	KEIHIN 13,5 mm (1)
090420A	15,5 mm (1)
090421	(2)
090422	(3)
090424	(5)
090425	(6)
090426	(7)
090427	(8)
090428	M10 x 1,25 (9)
090399B	(10)



***PIAGGIO SCOOTER**

090395	(1)
090396	(2)
090397	(3)
090398	(4) M10x1,25
090399	(5)
090399A	(6)
090412	(7)

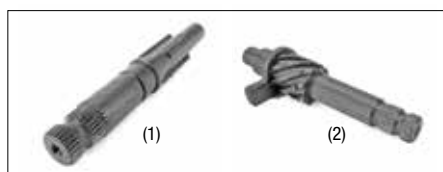

***AXE DE KICK**

090413	*MINARELLI AM6	(1)
090413A	*DERBI SENDA	(2)



***SCOOTER CHINOIS GY6**

090414	AXE DE KICK COMPLET	(1)
090414A	NOIX DE KICK	(2)



PIGNON INTERNE DEMARREUR
PIGNONE INTERNO

187196A *APRILIA / GILERA / PIAGGIO / KYMCO
OEM: 82531R



PIGNON INTERNE DEMARREUR
PIGNONE INTERNO

187196B *GILERA NEXUS 125 / PIAGGIO X9 125
OEM: 82612R



PIGNON INTERNE DEMARREUR
PIGNONE INTERNO

187196C *KYMCO 50 4T / GY6 50 4T
OEM: 00107245



PIGNON INTERNE DEMARREUR
PIGNONE INTERNO

187196D *PIAGGIO 50 4T / DERBI GPR / DRD
OEM: 96922R



PIGNON INTERNE DEMARREUR
PIGNONE INTERNO

187196E *PIAGGIO 125 2T / APRILIA SCARABEO 100
OEM: 431321 - AP8550009



PIGNON INTERNE DEMARREUR
PIGNONE INTERNO

187196F *PIAGGIO LIBERTY / SFERA
OEM: 293799



EMBRAYAGE DEMARREUR
RUOTA LIBERA AVVIAMENTO

187193A *250 XCITY 07-11 / MAJESTY 96-03 / XMAX 05-11
300 VERSITY 03-06
OEM: 4HC155900200 + 1COE55170000



EMBRAYAGE DEMARREUR
RUOTA LIBERA AVVIAMENTO

187193B *TMAX 500
OEM: 4NK-15590-000 + 5GJ-15517-0000



EMBRAYAGE DEMARREUR
RUOTA LIBERA AVVIAMENTO

187193E XMAX 125 / XCITY 125
OEM: 1B9E558000



ROUE LIBRE DEMARREUR
RUOTA LIBERA AVVIAMENTO

187193C *YAMAHA MAJESTY 125/180
OEM: 5XME55700000



ROUE LIBRE DEMARREUR
RUOTA LIBERA AVVIAMENTO

187193D *HONDA SH 125/150
OEM: 00126013 + 28125-KGF-911



ROUE LIBRE DEMARREUR
RUOTA LIBERA AVVIAMENTO

187193G *HONDA SH 300 / 250 FORZA
OEM: 28125-HN5-M41



ROUE LIBRE DEMARREUR
RUOTA LIBERA AVVIAMENTO

187193F *SUZUKI BURGMAN 125/150 02-2011
OEM: 12600-21822-000

MOTEUR MOTORE KICK SCOOTER LEVA M/M SCOOTER



DROP - *MINARELLI / PEUGEOT

ALU ALLUMINIO

090572 BLEU ANODISE BLU ANODIZZATO

090572A CHROME CROMO

090572C BLANC BIANCO

090572D NOIR NERO

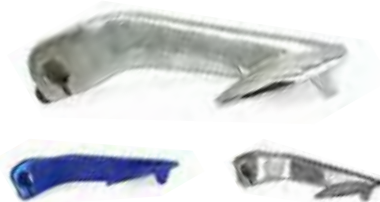

*MINARELLI

ALU ALLUMINIO

090510 BLEU ANODISE BLU ANODIZZATO

090510A ARGENT ARGENTO

ACIER ACCAIO

090515 CHROME CROMO



*PEUGEOT

ALU ALLUMINIO

090541 ARGENT ARGENTO

090542 STYLE CARBONE CARBONIO



*CPI OLIVER / HUSSAR / ARAGON 50CC 2TPS

ALU ALLUMINIO

090504 NOIR NERO

> KICK SCOOTER LEVA M/M



*PEUGEOT BUXY AM

ACIER ACCAIO

090501 CHROME CROMO



*MINARELLI BOOSTER / NITRO

ACIER ACCAIO

090503 CHROME CROMO

>



*MINARELLI AM6

ALU ALLUMINIO

090556 ARGENT ARGENTO

090556A BLEU ANODISE BLU ANODIZZATO

090556B ROUGE ANODISE ROSSO ANODIZZATO

090556C STYLE CARBONE CARBONIO



*DERBI SENDA / SENDA Euro 3

ALU ALLUMINIO

090557 ARGENT ARGENTO

090557A BLEU ANODISE BLU ANODIZZATO

090557B ROUGE ANODISE ROSSO ANODIZZATO

090557C STYLE CARBONE CARBONIO

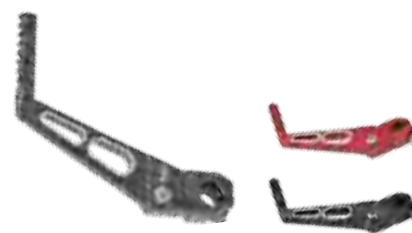

*MINARELLI AM6

ALU ALLUMINIO

090562A ROUGE ANODISE ROSSO ANODIZZATO

090562B NOIR NERO

090562D STYLE CARBONE CARBONIO



*DERBI SENDA / SENDA Euro 3

090563A ROUGE ANODISE ROSSO ANODIZZATO

090563B NOIR NERO

090563D STYLE CARBONE CARBONIO

ACIER NOIR

ACCAIO NERO

090505A *AM6

090505B *DERBI SENDA

MOTEUR MOTORE

KICK SCOOTER KICK 50CC A MARCE

> SELECTEUR DE VITESSE SELETTORE DI VELOCITÀ



*MINARELLI AM6

ALU	ALLUMINIO
090326	STYLE CARBONE ROUGE CARBONIO ROSSO
090326A	STYLE CARBONE NOIR CARBONIO NERO
090326B	STYLE CARBONE VERT CARBONIO VERDE



*DERBI

ALU	ALLUMINIO
090326C	STYLE CARBONE ROUGE CARBONIO ROSSO
090326D	STYLE CARBONE NOIR CARBONIO NERO
090326E	STYLE CARBONE VERT CARBONIO VERDE



*MINARELLI AM6

ALU	ALLUMINIO
090306	ARGENT ARGENTO
090307	BLEU ANODISE BLU ANODIZZATO
090309	STYLE CARBONE CARBONIO



*DERBI SENDA / SENDA Euro 3

ALU	ALLUMINIO
090320	ARGENT ARGENTO
090321	BLEU ANODISE BLU ANODIZZATO
090323	STYLE CARBONE CARBONIO



*CPI SM / SX

ALU	ALLUMINIO
090304	ARGENT ARGENTO
090304A	NOIR NERO
090304B	ROUGE ANODISE ROSSO ANODIZZATO



*MINARELLI AM6

ALU	ALLUMINIO
090310	NOIR NERO
090310A	BLEU ANODISE BLU ANODIZZATO
090310B	ROUGE ANODISE ROSSO ANODIZZATO
090310D	STYLE CARBONE CARBONIO



*DERBI SENDA / SENDA Euro 3

ALU	ALLUMINIO
090324	NOIR NERO
090324B	ROUGE ANODISE ROSSO ANODIZZATO
090324D	STYLE CARBONE CARBONIO



*APRILIA RS 50

ALU	ALLUMINIO
090325	ARGENT ARGENTO
090325A	BLEU ANODISE BLU ANODIZZATO
090325B	STYLE CARBONE CARBONIO

MOTEUR MOTORE VARIATEUR VARIATORE

> SCOOTER

CARENZI



VARIATEUR VARIATORE

286874	*BOOSTER / BW'S / NITRO / AEROX
286874A	*PEUGEOT SCOOTER
286874B	*RUNNER / STALK / NRG / TYPHOON
286874C	*CPI / KEEWAY / GENERIC
286874M	*KYMCO / SYM 2T 50CC

> SCOOTER

**TNT
Racing**



VARIO TNT RACING

286875	*MINARELLI VERT. BOOSTER / STUNT
286876	*PEUGEOT TREKKER / LUDIX
286878	*RUNNER / STALK / NRG / TYPHOON
286879	*MINARELLI HORIZ. NITRO / AEROX * OVETTO / NEOS / MACH-G
286880	*CPI / KEEWAY / GENERIC 1
286881	*STRADA / ROMA / AGILITY GY6 4T 50CC
286885	*SCOOTERONE 125 / AGILITY 125 GY6 4T 125CC

> SCOOTER

**TNT
Original**



***MINARELLI VERT. BOOSTER / BW'S**
287748 FLASQUE FIXE ALU
PULEGGIA FISSA ALLUMINIO



***MINARELLI VERT. BOOSTER / BW'S**
287747 FLASQUE MOBILE
PULEGGIA MOBILE



***PEUGEOT TREKKER**
287749 FLASQUE FIXE VARIATEUR
PULEGGIA FISSA ALLUMINIO



***PEUGEOT LUDIX**
287749A FLASQUE FIXE VARIATEUR
PULEGGIA FISSA ALLUMINIO



***CPI / KEEWAY**
287748A FLASQUE FIXE ALU
PULEGGIA FISSA ALLUMINIO



***CPI 50 / GYA 2 2TPS 1E40QMB**
090400A RONDELLE A EMPREINTE
PIASTRINA VARIATORE

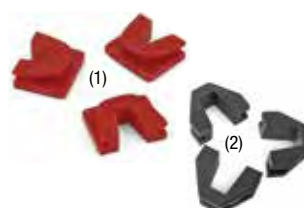

TACQUETS TASSELLI X3
289005 *MINARELLI (1)
289005A *PEUGEOT / PIAGGIO (2)



***MINARELLI VERT. BOOSTER / BW'S**
287741 RONDELLE A EMPREINTE
PIASTRINA VARIATORE

MOTEUR MOTORE VARIATEUR VARIATORE

> MAXI SCOOTER



***YAMAHA MAJESTY 250CC**
286885G



***YAMAHA XMAX 125CC**
286885A



***YAMAHA MAJESTY / SKYLINER 125 / 150CC**
286885E



***YAMAHA NMAX 125CC**
286885F



***HONDA SH 125/150**
286885C



***AGILITY 125/150**
286885B



***PIAGGIO 125CC**
286885D OEM: CM144403



***SCOOTER CHINOIS MOTEUR GY6 4T**
970670F

289005d
JEU DE 8 TACQUETS PLATEAU APPUI ADAPT. YAMAHA TMAX 530
>2012



TACQUETS TASSELLI

289005B	*YAMAHA XMAX 125CC (1)	X3
289005C	*HONDA SH 125CC (2)	X3
289005D	*YAMAHA TMAX 530 >2012	X8

> FLASQUE FIXE ALU PULEGGIA FISSA MAXISCOOTER



***YAMAHA NMAX 125CC**
287746F OEM: 2DPE76110000



***YAMAHA MAJESTY 250CC**
287746G



***YAMAHA XMAX/MAJESTY**
287746C OEM: 1B9-E7611-1000



***YAMAHA MAJESTY 400CC**
287746H



***HONDA SH 125/150**
287746A OEM: 22102-KGF-910



***KYMCO AGILITY 125/150**
287746B OEM: 00126115



***BURGMAN K7 125/150**
287746D



***PIAGGIO 125CC**
287746E OEM: 845607

> VARIATEUR CYCLO VARIATORE CICMOMOTORE



***PEUPEOT 103 SP**
287520



***MBK 51**
287530



ECROU DE VOLANT ELECTRONIQUE

DADO

170300	*103
170302	*MBK 51



ECROU DE VARIATEUR

DADO VARIATORE

170301	*103
090398	*PIAGGIO M10 X 1,25 CLE 14 (1)
090428	*PEUGEOT M10 X 1,25 CLE 15 (2)
170310	*BOOSTER M10 X 1,25 CLE 17 (3)

* Adaptable
* Adattabile

Les références du constructeur sont seulement indicatives et n'impliquent pas que les pièces de rechange viennent du constructeur.
I codici di riferimento originali sono indicativi e non implicano che i ricambi provengano necessariamente dalla stessa fabbrica del costruttore.

MOTEUR MOTORE GALETS VARIATEUR RULLI VARIATORE



***PEUGEOT / PIAGGIO AM**
BOX PARMakit DE 18 JEU DE GALETS 16 X 13
286900 4.5/5/5.5/6/6.5/7.5/8.5/9/10



***PIAGGIO / GILERA**
BOX PARMakit DE 24 JEU DE GALETS 19 X 15,5
286900A 4.5/5/5.5/6/6.5/7.5/8.5/9/10



***BOOSTER / NITRO**
BOX PARMakit DE 18 JEU DE GALETS 15 X 12
286900B 4.5/5/5.5/6/6.5/7.5/8.5/9/10



GALETS CERAMIQUE MAXI SCOOTER RULLI CERAMICA

***BUXY/TREKKER/FIGHT/TYPHOON 16 X 13**
286911 13,3 Grs X6

***SCOOTER CHINOIS 125 18 X 14**
286708 10,0 Grs X6
286707 11,0 Grs X6
286707A 12,0 Grs X6
286707B 13,0 Grs X6

***X8/X9 125 19 X 17**
286850 8,5 Grs X6

***SKYLINER/X-MAX 125 20 X 12**
286700A 9,0 Grs X6
286700D 10,0 Grs X6
286700C 14,0 Grs X6

***DRAND DINK 125 20 X 14,5**
286701 13,5 Grs X6
286701A 14,5 Grs X6

***HONDA SH/DYLAN/PANTHEON 125 20 X 14,6**
286703D 11,5 Grs X6

***HONDA PCX 125 20 X 14,6**
286703C 14,5 Grs X6

***SUZUKI BURGMAN 125 20 X 15**
286704A 12,9 Grs X6

***LEONARDO 125 20 X 17**
286702 8,5 Grs X6
286702A 9,0 Grs X6
286702B 9,5 Grs X6

***LEONARDO 150 20 X 17**
286702B 9,5 Grs X6

***PANTHEON / HONDA SH 300 23 X 18**
286703 19,0 Grs X6

***FORESIGHT / GRAND DINK 250 23 X 18**
286703A 20,0 Grs X6
286703B 21,0 Grs X6

***HEXAGON 250 24 X 18**
286704 25,0 Grs X6

***X9 500 25 X 21,8**
286706 24,0 Grs X6

***TMAX 500 25 X 14,8**
286705B 15 Grs (1) X8
286705 16 Grs X8
286705A 17 Grs X8

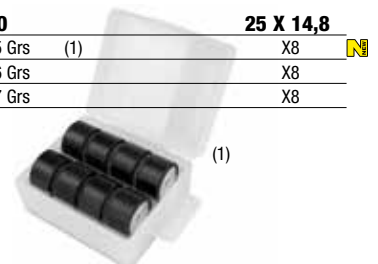

X6

Poids Weight	15x12	16x13	17x12	19x15,5	19x17
3,0 Grs	286800				
3,5 Grs	286801	286818			
4,0 Grs	286802	286819		286835	
4,5 Grs	286803	286820		286836	
5,0 Grs	286804	286821		286837	
5,5 Grs	286805	286822		286838	
6,0 Grs	286806	286823		286839	
6,5 Grs	286807	286824			
7,0 Grs	286808	286825	286851B		
7,5 Grs	286809	286826			
8,0 Grs	286810	286827			
8,5 Grs		286828			
9,0 Grs		286829			
10,0 Grs					286850B
12,0 Grs					286850C



JEU DE 3 X 6 GALETS 3 KIT X 6 RULLI

***BOOSTER/BWS/SLUNT/SLIDER/NITRO/AEROX**
287030 15 X 12 - 3,0 GRS / 4,0 GRS / 5,0 GRS

***BUXY/TREKKER/FIGHT/TYPHOON AM**
287035 16 X 13 - 4,0 GRS / 5,0 GRS / 6,0 GRS (1)

RESSORT D'EMBRAYAGE MOLLA



**RESSORT CORRECTEUR
MOLLA VARIATORE**
***BOOSTER / NITRO**
286871A

MOTEUR MOTORE EMBRAYAGE FRIZIONE

> RESSORT MOLLA

CARENZI



(1)

**RESSORTS EMBRAYAGE
MOLLE FRIZIONE** X9
*BOOSTER / BW'S
289003 Ø 1,4 (1)
289004 Ø 1,8



**RESSORTS EMBRAYAGE
MOLLE FRIZIONE** X3
*MINARELLI / PEUGEOT / PIAGGIO
286855 + 15%
286856 + 30%
286857 + 50%



**RESSORTS EMBRAYAGE
MOLLE FRIZIONE** X9
*MINARELLI / PEUGEOT / PIAGGIO
286859 + 15% + 30% + 50%

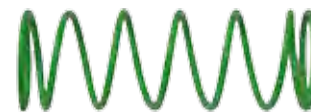

**RESSORT CORRECTEUR
MOLLA VARIATORE**
*BOOSTER * PEUGEOT
*BW'S * PIAGGIO
286865 286870 + 15%
286866 286871 + 30%
286867 286872 + 50%



parmakit



**RESSORT CORRECTEUR
MOLLA VARIATORE**
* PEUGEOT *BOOSTER
* PIAGGIO *NITRO
286873 286873C + 15%
286873A 286873D + 22%
286873B 286873E + 30%
286873F + 53%

> EMBRAYAGE FRIZIONE

parmakit



**EMBRAYAGE ALLEGE Ø107
FRIZIONE ALLEGGERITA Ø107**
287767A *MINARELLI / PEUGEOT / PIAGGIO



**EMBRAYAGE ALLEGE
FRIZIONE ALLEGGERITA**
287766A *MINARELLI BOOSTER / BW'S Ø105



CARENZI



**EMBRAYAGE ALLEGE Ø105
FRIZIONE ALLEGGERITA Ø105**
287642 *MINARELLI BOOSTER / BW'S



**EMBRAYAGE ALLEGE Ø107
FRIZIONE ALLEGGERITA Ø107**
287643 *MINARELLI / PEUGEOT / PIAGGIO



**TNT
Racing**



**EMBRAYAGE REGLABLE Ø105
FRIZIONE REGOLABILE Ø105**
287766 *MINARELLI BOOSTER / BW'S



**EMBRAYAGE REGLABLE Ø107
FRIZIONE REGOLABILE Ø107**
287767 *BOOSTER NM / BUXY
*TYPHOON / NITRO

* Adaptable
* Adattabile

Les références du constructeur sont seulement indicatives et n'impliquent pas que les pièces de rechange viennent du constructeur.
I codici di riferimento originali sono indicativi e non implicano che i ricambi provengano necessariamente dalla stessa fabbrica del costruttore.

MOTEUR MOTORE EMBAYAGE FRIZIONE

> SCOOTER

TNT
Original



***MINARELLI BOOSTER / BW'S / NITRO**

287750 *MINARELLI BOOSTER / BW'S OM Ø105

287752 *MINARELLI BOOSTER / BW'S / NITRO Ø107 1



***BOOSTER / BWS / NITRO / AEROX**

187193



ECROU DE VOLANT DADO

170311 *BOOSTER / BW'S / NITRO / AEROX



*** STRADA / MONZA ROMA 2/3**

971157U SCOOTEUR CHINOIS MOTEUR (KYMCO) GY6 139QMB/A



EMBAYAGE type Origine Ø107

CLUTCH Original type Ø107

287646 *MINARELLI / PEUGEOT / PIAGGIO



EMBAYAGE type Origine Ø105

CLUTCH Original type Ø105

287645 *MINARELLI BOOSTER / BW'S



***TREKKER / TYPHOON Ø107**

287751



***TREKKER / TYPHOON**

287623A Ø107mm CHROME CROMO



***MINARELLI SCOOTER**

287621 Ø105mm

287622 Ø107mm

287622B Ø107mm CHROME CROMO



ECROU DE VOLANT DADO

170311A *BOOSTER / BW'S / NITRO / AEROX



ECROU DE VOLANT CLUTCH NUT

170311B *PIAGGIO



MVT



***NITRO / BOOSTER Ø107**

35455

> CYCLO CICLOMOTORE

TNT
Original



***PEUPEOT 103**

287502



***CIAO**

S56310



***SOLEX**

S56978

MOTEUR MOTORE EMBRAYAGE MAXISCOOTER FRIZIONE MAXISCOOTER

> MAXISCOOTER

TNT
Original



***YAMAHA MAJESTY 125**
287768 OEM: 5DSE66200000-
R16141031A0-73503300



***YAMAHA XMAX 250**
287768B OEM: 5GM166200100



***YAMAHA XMAX 125CC**
287768I OEM: 1B9E66200000



***YAMAHA TMAX 500 2001-11**
287768K OEM: 5GJ163211000 +
5GJ163240000

***YAMAHA TMAX 530 <2012 (13PCS)** 
287768L OEM: 59C-16321 + 16325
+16324 .00

MADE IN JAPAN

MADE IN JAPAN



***PIAGGIO X9 500CC**
287768H OEM: AP8560053-826053



***PIAGGIO BEVERLY / MP3 400CC**
287768G OEM: 8488445



***PIAGGIO 125 X7-X8-X9**
287768E OEM: CM144005-B013246



***PIAGGIO 250 / 300CC**
287768J OEM: 8722515 / AP8577092 /
CM1440175



***PIAGGIO 125**
287768F OEM: CM1612015-CM144025



***HONDA SH 125 / AGILITY 125 4T / SYM**
287800A OEM: 22535-KCW-305



***HONDA SH 300**
287800B OEM: 23000-KTW-902



***HONDA S-WING / SH125 / KYMCO 125**
287800C OEM: 22535-KCW-305

MADE IN JAPAN



***BURGMAN 125 K7-SIXTEEN 125**
287768D OEM: 21501-46610-000



***SUZUKI BURGMAN 125 K2-K6**
287768C OEM: 2150120E60000



***KYMCO DINK 125/150**
287768A OEM: 00127961



***SCOOTERONE DAFIER**
971122H SCOOTER CHINOIS GY6 125CC 4T
152QMI

* Adaptable
* Adattabile

Les références du constructeur sont seulement indicatives et n'impliquent pas que les pièces de rechange viennent du constructeur.
I codici di riferimento originali sono indicativi e non implicano che i ricambi provengano necessariamente dalla stessa fabbrica del costruttore.

MOTEUR MOTORE

EMBAYAGE 50CC A BOITE FRIZIONE 50CC A MARCE



*DERBI SENDA EURO2/EURO3

35452
35452A RENFORCÉ CONSOLIDATO

*MINARELLI AM6

35453
35453A RENFORCÉ CONSOLIDATO



*MINARELLI AM6

287410A KEVLAR

*DERBI SENDA EURO 2/3

287400B KEVLAR

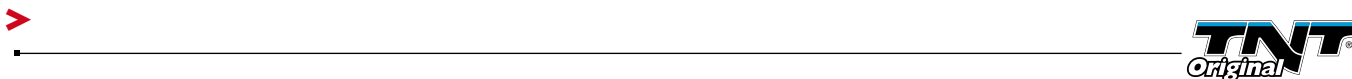

*MINARELLI AM6

287410

*DERBI SENDA

287400

*DERBI SENDA EURO 3

287400A

> BIELETTE D'EMBAYAGE BIELLETTA FRIZIONE



*MINARELLI AM6

090590 ALU BLEU ALLUMINIO BLU
090590A ALU ROUGE ALLUMINIO ROSSO
090590D ALU STYLE CARBONE ALLUMINIO CARBONIO

*DERBI SENDA

090591 ALU BLEU ALLUMINIO BLU
090591A ALU ROUGE ALLUMINIO ROSSO
090591B ALU NOIR ALLUMINIO NERO
090591D ALU STYLE CARBONE ALLUMINIO CARBONIO



PIGNON D'ENTRAINEMENT

GRUPPO PIGNONE

***YAMAHA TMAX 530**

260420B 17 D (2014-2016)

260420F 17 D (2017) 

260420C 18 D (2014-2016)

PIGNON D'ENTRAINEMENT

GRUPPO PIGNONE

***YAMAHA TMAX 530**

260420 -2 D (24 D) (2014-2016)

260420A +2 D (28 D) (2014-2016)

PIGNON D'ENTRAINEMENT

GRUPPO PIGNONE

***YAMAHA TMAX 530 2017**

260420D -2 D (24 D) (2017)

260420E +2 D (28 D) (2017)

ADAPTATEUR DE COURONNE

FLANGIA CNC

***YAMAHA TMAX 530**

264750B

COURONNE

CORONA

***YAMAHA TMAX 530**

264750C 38 DENTS

264750 40 DENTS

264750A 45 DENTS

Pour un kit chaîne il vous faut :

1 pignon (17 ou 18 dents) + 1 couronne (40 ou 45 dents) + 1 adaptateur de couronne.

Nous recommandons de la chaîne en 520 o-ring (de qualité DID ou RK)

Kit chaîne 17/45 = Meilleure accélération

Kit chaîne 18/40 = Meilleure allonge

Per un kit catena è necessario :

1 pignone / 17 o 18 denti) + 1 corona (40 o 45 denti) + 1 adattatore corona.

Noi raccomandiamo una catena 520 o-ring (di qualità DID o RK)

Kit trasmissione 17/45 = Migliore ripresa

Kit trasmissione 18/40 = Migliore allungo

MOTEUR MOTORE COURROIE CINGHIA

> GATES



POLYESTER



ARAMID



**ARAMID
DOUBLE DENTURE**

COURROIE SCOOT CRANTEE ARAMID GATES

268201	*BUXY/LUDIX	OEM: 729171
268200	*BOOSTER	OEM: 5RN-E7641-00
268203	*LX2 50/LX4 50	OEM: 828223/82645R
268207	*MBK EVOLIS	OEM: 3WF-17641-00
268209	*PGO BIG MAX	
268202	*TYPHOON/OVETTO 50 4 TEMPS	OEM: 436864/286162

COURROIE SCOOT CRANTEE GATES

268129A	*APRILIA SR 2000 LC	OEM: 27601-10E00
268126	*BOOSTER longueur originale + 1 cm	
2681203	*HONDA SFX/BALI	OEM: 23100-GW2-013
268129D	*HONDA X8R R RS	OEM: 23100-GI3-600 / 23100-GBY-960
268129F	*KYMCO VITALITY50/SYM JETSPORT X50	
268129E	*KYMCO ZX 50 / GY6 50cc 4T 10POUCE STRADA / ROMA	
268129G	*PIAGGIO ET2 50	OEM: 431190 / 286162 / 431190
268129H	*PIAGGIO LX2 50/LX4 50/ZIP 50 4 TEMPS	OEM: 828223/82645R
268129	*APRILIA SR200 LC	OEM: 436864/286162
268128A	*SCOOTER CHINOIS 2T GY6 MOTEUR 1PE40QMB 2T GRIDO STRIKE MONZA 2T	
268128B	*SCOOTER CHINOIS GY6 4T 50cc 12 POUCE STRADA LUXE / ROMA 12P / MONZA 4T	
268128	*TYPHOON/NRG/NTT-OVETTO 50 4 TEMPS	
268121	*RUNNER 50	OEM: 737830
268127	*BOOSTER/APRILIA	OEM 5RN-E7641-00
268125	*GRAND DINK 125	

COURROIE MAXISCOOT CRANTEE ARAMID GATES

268215	*APRILIA 125 / LEONARDO	OEM: 23100-KN7-671 00127985
268206	*HEXAGON LX4 125	
268216C	*HONDA SH 300ie DOUBLE CRANTEE	OEM: 23100-KTW-901
268214	*HONDA SH125-150/YAMAHA XMAX	OEM: 1B9-E7641-00/23100-KGF-901
268216D	*MAJESTY 400 DOUBLE CRANTEE	OEM: 5RU-17641-00
268212	*MBK 125 FLAM	OEM: 4CW-17641-02
268216B	*PIAGGIO 400/500 DOUBLE CRANTEE	OEM: 832738
268216G	*PIAGGIO 250 MP3 / GTX / X9	OEM: 843963/496304
268216E	*SUZUKI BURGMAN 250/400 98	OEM: B15 27601-15F10 / 27601-15F03
268216F	*HONDA SILVERWING 600/ABS	OEM: 23100-MCT-003
268217	*SCOOTERONE 125cc / GY6 125cc 4T 825-30-20	
268213	*SKYLINER	OEM: 5DS-17641-00
268211	*SUZUKI BURGMAN	OEM: 27601-21F11
268216A	*X9 200/BEVERLY 250 DOUBLE CRANTEE	
268210	*X9/ET4 LIBERTY	OEM: 841213/832023
268216	*YAMAHA TMAX	OEM: 5VU-17641-00
268129B	*DERBI ATLANTIS/LX4 125	
268129I	*SCOOTERONE 125cc / GY6 4T 125cc 835-20-30	
268129J	*SCOOTER CHINOIS GY6 125CC 4T743-20-30	
268217A	*GY6 125cc 4T / 158QMJ / 152QMI-A	OEM: 906-22.5-30
268215A	*KYMCO 125 DOWNTOWN / XCITING / DINK	OEM: 23100-LFA7-E0A / 00123267
268216H	*KYMCO DOWTOWN / DINK STREET 300 DOUBLE CRANTEE	
		OEM: 23100-LEA7-E00/00123257
268125A	*YAMAHA BOOSTER 100 / SUZUKI KATANA 50CC / PEUGEOT SYM 4TPS 12	
		OEM : 4VP-17641-00 / 27601-02EA0
268215B	*YAMAHA 250 MAJESTY / DEALIM 125 S2 / NS2 / LEONARDO 250 / 300CC	
		OEM: 23100-SE1-0000 / 8122639
268216J	*YAMAHA 250 XMAX / VERSITY 300	OEM: 5SE-E7641-00
268216K	*YAMAHA TMAX 530 2012- 2016	OEM: 59C-17641-0000
268216I	*SUZUKI BURGMAN 250/400 K7/K8	OEM: 27601-05H00



COURROIE POMPE A HUILE CINGHIA POMPA OLIO

267998	*PIAGGIO 125 CC
267999	*PIAGGIO 50 CC



COURROIE CYCLO CRANTEE

268100	*PEUGEOT 103
268140	*PIAGGIO CIAO
268110	*PEUGEOT 103 SPX/RCX
268120	*MBK 51

COURROIE CYCLO LISSE

268130	*PEUGEOT 103/VOGUE 13X875
268135	*MBK 51

> MITSUBOSHI



COURROIE SCOOTER MITSUBOSHI

268204	*SYM / PEUGEOT / HALO / BOSTON 12P	18.3 X 775
268204A	*SCOOTER GY6 4TPS 10P / BOSTON 10P / ROMA 10P	17.7 X 8.5 X 681
268204B	*SCOOTER GY6 2TPS 12P / GRIDO / OTTO 50CC 12P	16.6 X 8 X 792

> TNT ORIGINAL



COURROIE SCOOT CRANTEE TNT ORIGINAL

268200A	*BOOSTER/NITRO	OEM: 5RN-E7641-00
268201A	*BUXY / TKR / SPEEDFIGHT / VIVACITY / LUDIX	OEM: 729171
268129K	*KYMCO ZX 50 / GYA 50CC 4T 10" / ROMA / AGILITY 10"	
268202A	*TYPHOON / NRG / NTT / APRILIA SR200 LC	OEM: 436864/286162
268129M	*GY6 4T 50cc 12P / AGILITY 12P	OEM: 729-18-30
268129N	*GY6 2T 50CC MOTEUR 1PE40QMB 2T / 788-17-28 GRIDO / OTTO / FASTINO	

MOTEUR MOTORE COURROIE CINGHIA

CC	Modèle	Moteur	Année	Ref. OEM	BOOST™	BOOST™ +	BOOST™ DN
Aeon							
50	Aero 2T		99-09	23100-113-000	268128A	268207	
50	Echo 2T		99-09	23100-113-000	268128A	268207	
50	Regal 2T		99-09	23100-113-000	268128A	268207	
50	Torch		99-01	23100-113-000	268128A	268207	
Aprilia							
50	*Mojito Custom 2T	Piaggio	04-08	286162	268129G		
50	*Scarabeo 2T/Street/Rst	Piaggio	05-10	286162	268129G		
50	*SR H2O R Piaggio carburator		04-08	8515110/436864	268129	268202	
50	*SR H2O R Factory		04-10	286162	268129G		
50	*SR H2O Street	Piaggio	03-10	286162	268129G		
50	*SR H2O Street IE Piaggio injection		03-10	286162	268129G		
50	Amico LK/LX/GL/Sport		92-99	8206109	268127	268200	
50	Area 51		98-00	8206109	268127	268200	
50	Gulliver Air/LC		94-00	8206109	268127	268200	
50	Mojito Custom 2T	Piaggio	04-08	8515110/436864	268129	268202	
50	Rally Air/LC		94-04	8206109	268127	268200	
50	Scarabeo		97-00	8206109	268127	268200	
50	Scarabeo 2T/Street	Minarelli	93-06	8206109	268127	268200	
50	Scarabeo 2T/Street/Rst	Piaggio	05-10	8570076/8271R	268129L		
50	Scarabeo 4T		03-06	8570076/8271R	268129L		
50	Scarabeo 4T/Rst/Euro 3		06-10	82712R	268129L		
50	Scarabeo Quattro 4V-4T		09-10	82712R	268129L		
50	Sonic 50 AC/LC		99-00	8206818	268129L	268207	
50	Sonic LC/GP		98-08	8206818	268129L	268207	
50	Sport City One 2T		08-10	82712R	268129L		
50	Sport City One 4T		08-10	82712R	268129L		
50	SR 50 R Factory		09-11	8515110/436864	268129	268202	
50	SR 50 racing		00-01	n/a	268127	268200	
50	SR Air Esquire/Urban/Wave/Sunfire	Minarelli horiz.	94-96	8206109	268127	268200	
50	SR Air Sport	Minarelli	99-02	8206109	268127	268200	
50	SR Air Urban/Viper/Replica/europe	Minarelli vert.	93-96	8206109	268127	268200	
50	SR Air WWW	Minarelli	97-02	8206109	268127	268200	
50	SR H2O R Piaggio carburator		04-08	286162	268129G		
50	SR H2O R Factory Piaggio injection		04-10	833982	268129	268202	
50	SR H2O Racing/Stealth		97-00	8206109	268127	268200	
50	SR H2O Street Piaggio carburator		03-10	8515110/436864	268129	268202	
50	SR LC Replica		94-96	8206109	268127	268200	
50	SR Netscaper		97-00	8206109	268127	268200	
50	SR R	Piaggio	04-10	8515110/436864	268129	268202	
50	Stealth	Minarelli	97-00	8206109	268127	268200	
50	Urban		93-96	8206109	268127	268200	
50	WWW		97-02	8206109	268127	268200	
51	Sport City One/Street 2 T		08-10	82712R	268129L		
125	*SR		99-...	8550160	268129B	268206	
125	Habana Custom		99-02	8550363/825059	268129B	268206	
125	Leonardo ST	Rotax	96-05	280100	268125		
125	Mojito Custom		99-02	8550363/825059	268129B	268206	
125	Scarabeo GT	Rotax	99-04	280102	268125		
125	Scarabeo Light	Aprilia	07-09	2MCA000860/856026		268211	
125	Scarabeo Light IE		09-10	2MCA000860/856026		268211	
125	SR		99-...	8550130		268213	
125	SR 125 Racing		00-01	8550130		268213	
150	*SR		99-...	8550160	268129B	268206	
150	Leonardo 150		96-03	280102		268215	
150	Leonardo ST	Rotax	96-05	280100	268125		
150	Scarabeo 150		99-03	280102		268215	
150	Scarabeo GT	Rotax	99-04	280102	268125		
150	SR		99-...	8550130		268213	
200	Atlantic		02-08	8580246/840908			268216A
200	Atlantic 200		02-05	8580207/8580246			268216A
200	Scarabeo Light	Aprilia	07-09	2MCA000860/856026		268211	
200	Scarabeo Light IE		09-10	2MCA000860/856026		268211	
250	Atlantic		03-06	8580261/843963			268216G
250	Atlantic IE/Euro 3		06-09	843963/82941R			268216G
250	Leonardo		99-05	8122639			268215B
300	Atlantic IE/Euro 3		10-11	82941R/843963			268216G
300	Leonardo		04-06	8122639			268215B
400	Atlantic Sprint		06-09	8560188/832738			268216B
400	Scarabeo Light		06-09	8560188/832738			268216B
500	Atlantic		03-05	8560188/832738			268216B
500	Atlantic Sprint		05-08	8560188/832738			268216B
500	Scarabeo GT/ABS/Light		02-07	8560188/832738			268216B
n/a	Blue star		n/a	n/a	268127	268200	
n/a	Fun		n/a	n/a	268127	268200	
Benelli							
50	491 RR/ST	Minarelli	97-02	R16140011A0	268127	268200	
50	491 Sport/Racing	Minarelli	98-02	R16140011A0	268127	268200	
50	491GT/SP		97-02	R16140011A0	268127	268200	
50	K2 Air/LC/Namur	Minarelli	98-...	R16140011A0	268127	268200	

CC	Modèle	Moteur	Année	Ref. OEM	BOOST™	BOOST™ +	BOOST™ DN
50	Naked	Minarelli	02	R16140011A0	268127	268200	
50	Pepe LX	Minarelli	08-06	R16140011A0	268127	268200	
50	Pepe LX/Old		97-09	R030424102000	268128A	268207	
50	QuattronoveX		08-09	R030424102000	268128A	268207	
125	Velvet Touring		08-09	R050324102000	268129I	268217	
125	Velvet Touring		99-07	R16140631A0		268213	
150	Velvet Touring		08-09	R050324102000	268129I	268217	
150	Velvet Touring		99-07	R16140631A0		268213	
250	Velvet Touring		98-07	R16040171A0		268215B	
n/a	491 army		97-...	n/a	268127	268200	
n/a	GT		97-...	n/a	268127	268200	
n/a	Sport		97-...	n/a	268127	268200	
n/a	Superbike		n/a	n/a	268127	268200	
Betamotor							
50	Ark LC/K		96-08	330129	268127	268200	
50	Chrono 502		95-...	330129	268127	268200	
50	Eikon 50		99-...	330129	268127	268200	
50	Quadra		95-...	330129	268127	268200	
50	Tempo 13+		94-95	330129	268127	268200	
50	Tempo 16+		96-...	330129	268127	268200	
125	Eikon		99-...	361075	268125		
150	Eikon		99-...	361075	268125		
Bmw							
125	C1		00-...	11117653432	268125		
Cagiva							
50	City		n/a	Y00MA0063	268129G		
50	Cucciolo		98-00	800091314	268129B	268206	
50	Cucciolo Air		n/a	00G02602371	268129B	268206	
50	Progress 50		n/a	n/a	268129B	268206	
50	Progress Air		n/a	00G02602371	268129B	268206	
50	Progress LC		n/a	00G02602371	268129B	268206	
125	Cucciolo Nuvola		n/a	800093625	268129B	268206	
CF Moto							
125	CF 125 T-21A E-Charm IE		n/a	1P52MI-A-053000		268214	
125	Urban R		n/a	1P52MI-A-053000		268214	
150	CF 150 T-5A E-Charm Carb.		n/a	1P52MI-A-053000		268214	
150	CF 150 T-5A E-Charm IE		n/a	1P52MI-A-053000		268214	
150	CF 150 T-5I IE		n/a	1P52MI-A-053000		268214	
150	CF Glory IE		n/a	1P52MI-A-053000		268214	
150	Urban R		n/a	1P52MI-A-053000		268214	
250	CF-T F/E Touring/Fashion/VIP		n/a	172MM-052700		268211	
China Motori							
50	1P39QMB 4T		n/a	729-18-30	268128B		
50	1PE40QMB 2T		n/a	788-17-28/780-16.5-30	268128A	268207	
50	2T Motor QJ 107/108		n/a	24107B09F000	268129B	268206	
50	GY6 139 QMA 4T Long carter		n/a	729-18-30	268128B		
50	GY6 139 QMB 4T Short carter		n/a	669-18-30	268129E		
125	152 QMI-A 4T		n/a	906-22.5-30		268214	
125	GY6 152 QMI 4T		n/a	743-20-30	268129J		
150	158 QMJ 4T		n/a	906-22.5-30		268214	
150	GY6 152 QMI 4T 150E-103		n/a	743-20-30	268129J		
250	1P69MM 4T YP 250		n/a	871-23-28		268215B	
250	BN 172 MM 4T CN 250		n/a	828-22.5-30		268211	
China Scooter							
50	GMI 102 4T		n/a	669-18-30	268129E		
50	GMI 104 4T		n/a	669-18-30	268129E		
50	GMI 106 4T		n/a	669-18-30	268129E		
50	GMI 107/XP 2T		n/a	24107B09F000	268129B	268206	
50	GMI 108 2T		n/a	24107B09F000	268129B	268206	
50	GMI 109 2T		n/a	24107B09F000	268129B	268206	
50	Aragon		n/a	1PE40QMB-101	268129B	268206	
50	Aragon GP/Paddock/Club		07-08	61A-12211-00-00	268128A	268207	
50	Bingo FL		02	1PE40QMB-101/61A-12211-00-00	268128A	268207	
50	Formula R AC		08	61A-12211-00-00	268128A	268207	
50	GTS LC		02	61A-12211-00-00	268128A	268207	
50	Hussar		00	23100-113-000	268128A	268207	
50	Hussar SL/FL/Euro 2		01-05	1PE40QMB-101/61A-12211-00-00	268128A	268207	
50	Oliver/City/Sport		03-07	1PE40QMB-101/90A-12211-00-00	268128A	268207	
50	Popcorn Muz Moskito SX		99-00	23100-113-000	268128A	268207	
50	Popcorn SL/FL/Euro 2		01-04	1PE40QMB-101/61A-12211-00-00	268128A	268207	
50	RX QJ 50 QT-2		n/a	24107B01F000	268128A	268207	
50	Tennesse		01-...	1PE40QMB-101	268128A	268207	
150	GTR		n/a	81J-12211-00-00		268214	
Daelim							
50	SE-1 E-Five/Euro 2		02-03	23100-SE1-0000	268129A		
50	SJ 50		n/a	n/a	268129A		
50	SJ S-Five/Euro 2		01-03	23100-SE1-0000	268129A		
125	NS I		98	23100-SA1-0000		268215B	
125	NS II Otello		99	23100-SA1-0000		268215B	

* Adaptable
* Adattabile

Les références du constructeur sont seulement indicatives et n'impliquent pas que les pièces de rechange viennent du constructeur.
I codici di riferimento originali sono indicativi e non implicano che i ricambi provengano necessariamente dalla stessa fabbrica del costruttore.

MOTEUR MOTORE COURROIE CINGHIA

CC	Modèle	Moteur	Année	Ref. OEM	BOOST™	BOOST™ +	BOOST™ DN
125	NS III Otello/DLX/Euro 2		00-05	23100-SA1-0000		268215B	
125	NS Otello FI		07	23100-SA1-0000		268215B	
125	NS Otello SE		06	23100-SA1-0000		268215B	
125	Othello 125		n/a	23100-SA1-0000		268215B	
125	S2 125		06-...	n/a		268215B	
125	S-2 Freewing		n/a	23100-SA1-0000		268215B	
125	S-2 Freewing FI		09	23100-SA1-0000		268215B	
125	SC Besbi		08-09	116500-152QMI-0100	268129I	268217	
125	SG 125		n/a	n/a		268215B	
125	SL Hystory		01-...	23100-SA1-0000		268215B	
Derbi							
50	*Atlantis 02/Bullet/City/Two Chic/Red Bullet/2T Euro 2	Piaggio	02-10	286162	268129G		
50	*Boulevard 2T		09-11	286162	268129G		
50	*GP1 Euro 2/Race E2/Open E2	Piaggio	01-10	286162	268129G		
50	Atlantis 2T/Euro 2	Piaggio	07-10	436864	268129	268202	
50	Atlantis 4T/Euro 2		04-10	842907		268209	
50	Atlantis AC/LC	Derbi	99-01	00G02605371	268129B	268206	
50	Atlantis 02/Bullet/Red Bullet	Piaggio	02-05	436864	268129	268202	
50	Atlantis 02/Bullet/Red Bullet	Piaggio	02-05	436864	268129	268202	
50	Atlantis 02/City/Two Chic	Piaggio	03-06	436864	268129	268202	
50	Atlantis 02/City/Two Chic	Piaggio	03-06	436864	268129	268202	
50	Boulevard 2T		09-11	82712R	268129L		
50	Boulevard 4T		09-11	842907		268209	
50	GP1	Piaggio	01-03	436864	268129	268202	
50	GP1 Euro 2	Piaggio	05	436864	268129	268202	
50	GP1 Open EU2	Piaggio	06-10	436864	268129	268202	
50	GP1 Race EU2	Piaggio	05-09	436864	268129	268202	
50	Hunter		99-...	00G02602371	268129B	268206	
50	Hunter		96-97	00G02602371	268129B	268206	
50	Manhattan		97	00G02602371	268129B	268206	
50	Paddock		98-99	00G02602371	268129B	268206	
50	Predator 02		98-01	00G02605371	268129B	268206	
50	Predator 02/LC		98-01	00G02605371	268129B	268206	
100	Atlantis 2T		00-01	00G02606371	268129B	268206	
200	Boulevard Euro 3		05-06	840908			268216A
250	GP1 Low seat E3		06-08	82941R/843963			268216G
n/a	Easy		n/a	n/a	268127	268200	
n/a	Manhattan		n/a	n/a	268129B	268206	
E-Ton							
50	Alta 49 4T		n/a	813211	268128B		
50	Beamer 2T		00-04	650207	268128A	268207	
50	Beamer II 2T		05-06	650207	268128A	268207	
50	Beamer III 2T		07-09	650207	268128A	268207	
50	Beamer Matrix 2T		05-06	650207	268128A	268207	
50	Beamer Matrix/II 2T		07-08	650207	268128A	268207	
50	Beamer R2 2T		07	650207	268128A	268207	
50	Beamer/II/III 2T		n/a	650207	268128A	268207	
50	Matrix		09	650207	268128A	268207	
50	Sport 4T		09	813566	268128B		
150	Beamer R4		07-09	800266	268129J		
150	Matrix R4		09	800266	268129J		
150	Sport		09	814218	268129I	268217	
Fantic							
n/a	Big wheel		n/a	n/a	268127	268200	
Generic							
50	Ideo 2T		05-08	n/a	268128A	268207	
50	ROC 2T		08	n/a	268128A	268207	
50	XOR 2T/Compet/Stroke		05-08	n/a	268128A	268207	
Gilera							
50	*DNA GP Experience		00-07	286162	268129G		
50	*Easy Moving		95-96	286162	268129G		
50	*Ice		01-...	286162	268129G		
50	*Runner SP/Race/FL/Poggiali/Purejet/Race/SC		97-10	286162	268129G		
50	*Stalker Euro 2/Special/Naked		97-10	286162	268129G		
50	*Storm		93-96	286162	268129G		
50	*Storm Euro 2		07-09	286162	268129G		
50	*Typhoon X/XR		93-09	286162	268129G		
50	DNA GP Experience		00-07	480852/82712R	268129L		
50	Easy Moving		95-96	431190	268129G		
50	Ice		01-...	436864/186162	268129	268202	
50	Runner DD/SP/LC		97-...	436864	268129	268202	
50	Runner Purejet		05-09	833982	268129	268202	
50	Runner Purejet		02-04	436864/833982	268129	268202	
50	Runner SP		05-08	436864	268129	268202	
50	Runner SP Race		06-08	436864	268129	268202	
50	Runner SP Simoncelli		08-10	436864	268129	268202	
50	Runner SP Special Edition		07-08	436864	268129	268202	
50	Runner SP ST		08-10	436864	268129	268202	
50	Stalker		97-02	436864	268129	268202	
50	Stalker base		97-04	436864/286162	268129	268202	
50	Stalker Euro 2/Special Sport		03-10	436864	268129	268202	

CC	Modèle	Moteur	Année	Ref. OEM	BOOST™	BOOST™ +	BOOST™ DN
50	Stalker Naked		08-10	436864	268129	268202	
50	Storm		93-96	286162/430728	268128A	268207	
50	Storm Euro 2		07-09	436864	268129	268202	
50	Typhoon		00-...	430728	268128A	268207	
50	Typhoon X		93-99	430728	268128A	268207	
50	Typhoon XR		00-09	436864	268129	268202	
125	*Runner FX/SP 2T		97-02	431370		268213	
125	*Typhoon X/XR		95-00	431370		268213	
125	Runner DD/FX/SP		01-...	n/a		268213	
125	Runner FX/SP 2T		97-02	434812		268213	
125	Typhoon X/XR		95-00	434812/431370		268213	
180	*Runner FXR/SP 2T		97-02	431370		268213	
180	DNA 4T		01-...	827639/832623/840908			268216A
180	Runner DD/SP		97-00	n/a		268213	
180	Runner FXR/SP 2T		97-02	484497		268211	
180	Runner VXR 4T		01-...	827639/832623/840908			268216A
180	VXR 4T		n/a	827639/832623/840908			268216A
200	Runner		02-...	n/a		268213	
200	Runner VXR 4T		02-...	840908			268216A
200	Runner VXR/Race/SC/ST/Euro 3		02-10	840908			268216A
200	VXR 4T		02-...	840908			268216A
250	Nexus Euro 3/SP		06-08	82941R/843963			268216G
300	Nexus Euro 3		08-10	82941R/843963			268216G
500	Fuoco IE		07-08	832738			268216B
500	Nexus Euro 3/SP		03-09	832738			268216B
800	GP		08-...	845010		268206	
Honda							
50	Bali		93-...	23100-GW2-013	268129C		
50	NH		n/a	23100-GC7-004		268110	
50	NH Lead		n/a	23100-GC7-004		268110	
50	NPS Zoomer 4T		04-09	23100-GEZ-003	268129	268202	
50	SFX/S		95-01	23100-GW2-013	268129C		
50	SH Fifty		96-03	23100-GBY-901/960	268129D		
50	SJ Bali		93-...	23100-GW2-013	268129C		
50	Sky SGX/De Luxe		97-...	23100-GBY-901/960	268129D		
50	SRX Shadow		98-...	23100-GW2-013	268129C		
50	SXR SFX 50 MM		98-99	23100-GW2-013	268129C		
50	SZX X8R-S/X		98-01	23100-GBY-901/960	268129D		
50	Yupi		n/a	n/a	268129G		
75	Scoopy SH		n/a	n/a	268129D		
90	SRX Shadow		98-...	23100-GW3-003/013	268128B		
100	Lead		96-99	23100-GC7-004	268129H	268203	
100	SCV Lead 4T		03-07	23100-GCC-771	268129H	268203	
100	SJ Bali/EX		96-99	23100-GW3-003/013	268128B		
125	@		n/a	23100-KGF-900		268214	
125	CH Spacy		86-96	23100-KN7-671/KV8840	268125		
125	Chiocciolo		00-...	23100-KGF-901/23100-KGG-900		268214	
125	FES Foresight		n/a	n/a		268214	
125	FES Pantheon 2T		98-02	23100-KFF-900		268214	
125	FES Pantheon 4T		05-06	23100-KGF-901		268214	
125	FES Pantheon 4T		03-04	23100-KGG-911		268214	
125	FES Pantheon 4T		98-01	23100-KGG-900		268214	
125	FES S-Wing/ABS		07-10	23100-KGF-901		268214	
125	NES		n/a	n/a		268214	
125	NES @Chiocciola/Arobace		00-06	23100-KGF-901/23100-KGG-900		268214	
125	Pantheon		n/a	23100-KFF-901		268214	
125	PES PS i		06-10	23100-KGF-901		268214	
125	Scoopy SH		n/a	n/a		268214	
125	SES		n/a	n/a		268214	
125	SES Dylan		02-06	23100-KGF-901/23100-KGG-900		268214	
125	SH		01-04	23100-KGF-901		268214	
125	SH i Injection		05-10	23100-KGF-901		268214	
125	SH i Injection Disco/Disco		09-10	23100-KGF-901		268214	
125	Shadow SRX90		01-04	23100-KGF-901		268214	
150	@		n/a	23100-KGF-900		268214	
150	CH Spacy		88	23100-KN7-671	268125		
150	Chiocciolo		00	23100-KGF-901/23100-KGG-900		268214	
150	FES Pantheon 2T		98-02	23100-KFF-900		268214	
150	FES Pantheon 4T		98-01	23100-KGG-900		268214	
150	FES Pantheon 4T		03-06	23100-KGG-911		268214	
150	FES S-Wing/ABS		07-10	23100-KGG-911		268214	
150	Lead SH		01-...	n/a		268214	
150	NES @Chiocciola/Arobace		01-06	23100-KGG-911		268214	
150	NES @Chiocciola/Arobace frame nr ending 0016853		00-...	23100-KGF-901		268214	
150	NES @Chiocciola/Arobace frame nr from 0016853		00	23100-KGG-911		268214	
150	Pantheon		n/a	23100-KFF-901		268214	

MOTEUR MOTORE COURROIE CINGHIA

CC	Modèle	Moteur	Année	Ref. OEM	BOOST™	BOOST™ +	BOOST™ DN
150	PES PS i		06-10	23100-KGG-911		268214	
150	Scoopy SH		n/a	n/a		268214	
150	SES Dylan		02-06	23100-KGG-911		268214	
150	SH		01-04	23100-KGG-911		268214	
150	SH i Injection		05-10	23100-KGG-911		268214	
150	SH i Injection Disco/Disco		09-10	23100-KGG-911		268214	
250	CN		95-99	n/a		268213	
250	CN Helix/Spazio		90-99	23100-KM1-671		268211	
250	NSS Forza X/EX		08-10	23100-KVZ-631			268216E
300	SH IE		07-10	23100-KTW-901			268216C
600	FJS Silver Wing/ABS		01-10	23100-MCT-003			268216F
Hyosung							
50	SF		n/a	n/a	268129G		
50	SF B Racing		01-...	27601HG2600	268129G		
50	SF Euro 2		05-07	27601HG2600	268129G		
50	SF Prima		00-...	27601HG2600	268129G		
50	SF R		n/a	27601HG2600	268129G		
50	SF Racing		n/a	27601HG2600	268129G		
50	SF Rally		07	27601HG2600	268129G		
Italjet							
50	*Jet Set		02-03	210286162	268129G		
50	*Torpedo 2T	Piaggio	01-03	210286162	268129G		
50	Dragster		98-00	4401702050	268127	268200	
50	Formula Air/LC		94-00	338127227		268200	
50	Jet Set		02-03	210436864	268129	268202	
50	New Torpedo 50		n/a	478954/828223	268129H	268203	
50	Pista 2		95-96	3351015	268126		
50	Scoop		93-...	3351015	268126		
50	Scoop 2/3		93-...	3351015	268126		
50	Torpedo 2T	Piaggio	01-03	210480852	268129L		
50	Torpedo 4T		n/a	478954/828223	268129H	268203	
50	Torpedo 4T		02-03	210480852	268129L		
50	Yankee		92-...	3351015	268126		
125	*Dragster		99-03	210431370		268213	
125	Dragster		99-03	210434812		268213	
125	Jupiter		02-03	4871702090		268213	
125	Millenium		00-03	4871702090		268213	
125	Torpedo		99-00	210825059	268129B	268206	
125	Yankee		n/a	n/a	268127	268200	
150	Jupiter		02-03	4871702090		268213	
150	Millenium		00-03	4871702090		268213	
150	Torpedo	CF Moto	n/a	TOR00194		268214	
180	*Dragster		99-03	210431370		268213	
180	Dragster		99-03	210484497		268211	
250	Jupiter		01-03	4711702092		268215B	
n/a	Cruise		n/a	n/a		268213	
F-ACT							
50	F-ACT 2T		07-08	24107B01F000	268128A	268207	
50	Flash 2T		07-08	24107B01F000	268128A	268207	
50	Focus		06	24107B01F000	268128A	268207	
50	Hurricane		06-08	24107B01F000	268128A	268207	
50	Matrix		06-08	E082101-FY-B0E2-0000	268128A	268207	
50	RY8/SP		06-08	24107B01F000	268128A	268207	
125	ARN		06-08	24160J05F000	268121	268215	
125	F-ACT		07-08	24160J05F000	268121	268215	
125	Focus		06	24160J05F000	268121	268215	
125	Matrix		06-08	24160J05F000	268121	268215	
125	Outlook		07-08	2,00013E+11		268214	
150	ARN		06-08	24160J05F000	268121	268215	
150	F-ACT		07-08	24160J05F000	268121	268215	
150	Focus		06	24160J05F000	268121	268215	
150	Matrix		06-08	24160J05F000	268121	268215	
150	Outlook		07-08	2,00013E+11		268214	
Kreidler							
50	RC-E Flory 2T		n/a	n/a	268128A	268207	
50	RMC-E Florett Race 2T		08	n/a	268128A	268207	
50	RMC-E Florett/XL 2T		n/a	n/a	268128A	268207	
50	RMC-E Hiker/Sport DD		n/a	n/a	268128A	268207	
50	RMC-G Florett Race 2T		08	n/a	268128A	268207	
50	RMC-H Galactica DD		n/a	n/a	268128A	268207	
125	QM125T-10R RMC-G El Ninjio		n/a	835-20-30	268129I	268217	
125	RMC-D Florett		06-07	835-20-30	268129I	268217	
125	RMC-E Hiker/Sport DD		09	835-20-30	268129I	268217	
125	RMC-F		n/a	835-20-30	268129I	268217	
125	RMC-H Galactica DD		n/a	835-20-30	268129I	268217	
Ktm							
50	K 50		n/a	n/a	268127	268200	
Kymco							
50	Agility 4T 12>		05-06	23100-KEB7-9000 00107541	268128B		
50	Agility 4T R12 12>		07-10	23100-KEB7-9000 00107541	268128B		

CC	Modèle	Moteur	Année	Ref. OEM	BOOST™	BOOST™ +	BOOST™ DN
50	Agility 4T R16 16>		08-10	23100-KEB7-9000 00107541	268128B		
50	Agility 4T RS 12>		09-10	23100-KEB7-9000 00107541	268128B		
50	Bet & Win Euro 2		02-...	23100-KEB7-9000 00107541	268128B		
50	Dink 2T/LC/Classic/Euro 2		99-07	23100-KEB7-9000 00107541	268128B		
50	Dink Classic		98-02	23100-KEB7-9000 00107541	268128B		
50	Dink Rst 4T		07-10	23100-KEB7-9000 00107541	268128B		
50	Fever ZX/Euro 2		99-07	23100-KCX-900 00107842	268129H	268203	
50	Grand Dink 2T/S		05-08	23100-KEB7-9000 00107541	268128B		
50	K 12 Scout		95-00	23100-KCX-900 00107842	268129H	268203	
50	KB		95-00	23100-KCX-900 00107842	268129H	268203	
50	Like 2T		09-10	23100-KEB7-9000 00107541	268128B		
50	Like 4T		09-10	23100-KEB7-9000 00107541	268128B		
50	People 2T/Euro 2		99-10	23100-KEB7-9000 00107541	268128B		
50	People S 2T		05-10	23100-KEB7-9000 00107541	268128B		
50	People S 4T		06-10	23100-KEB7-9000 00107541	268128B		
50	Super 8 2T		09-10	23100-KEB7-9000 00107541	268128B		
50	Super 8 4T		07-10	23100-KEB7-9000 00107541	268128B		
50	Super 9/Sport/Euro 2 2T		00-07	23100-KEB7-9000 00107541	268128B		
50	TopBoy On/Off Cobra		97-04	23100-KEB7-9000 00107541	268128B		
50	Vitality 2T/4T		04-...	23100-KEB7-9000 00107541	268128B		
50	Yup Euro 2		02-...	23100-KEB7-9000 00107541	268128B		
125	Agility Euro 3 4T		n/a	23100-KFB-8000 00127785	268129J		
125	Bet & Win		00-...	23100-KN7-670/1 00127985	268125		
125	Bet & Win Euro 2		01-07	23100-KN7-671 00127985	268125		
125	Capture Trend		09-...	23100-KFBF-90B	268129J		
125	Dink Classic/Euro 2		02-07	23100-KN7-670/1 00127985	268125		
125	Dink Euro 3		06-10	23100-KN7-670/1 00127985	268125		
125	Dink/Dink LX		97-07	23100-KN7-670/1 00127985	268125		
125	DownTown i		09-10	23100-LFA7-E0A 00123267		268215A	
125	Grand Dink Euro 2		01-07	23100-KN7-671 00127985	268125		
125	Grand Dink Euro 3		08-09	23100-KN7-671 00127985	268125		
125	Grand Dink S		08-09	23100-KN7-671 00127985	268125		
125	Heroism		95-97	23100-KFB 8000 00127785	268129J		
125	Movie		98-00	23100-KFB 8000 00127785	268129J		
125	Vivio		00-...	23100-KFB-8000 00127785	268129J		
125	Vivio 4T		n/a	23100-KFB-8000 00127785	268129J		
125	V-Link S		n/a	23100-KBF-9000-M1	268129J		
125	V-Link SR		n/a	23100-KBF-90B	268129J		
150	Bet & Win		00-...	23100-KN7-670/1 00127985	268125		
150	Bet & Win Euro 2		01-07	23100-KN7-671 00127985	268125		
150	Dink Classic Euro 2		02-07	23100-KN7-670/1 00127985	268125		
150	Dink/Dink LX		97-07	23100-KN7-670/1 00127985	268125		
150	Grand Dink Euro 2		01-07	23100-KN7-671 00127985	268125		
150	Grand Dink S		08-09	23100-KN7-671 00127985	268125		
150	Heroism		95-97	23100-KFB-8000 00127785	268129J		
150	Vivio		00-...	23100-KBF-9000 00127785	268129J		
200	Dink Classic Euro 2		04-07	23100-LBF6-E00 00127021		268215	
500	X-Citing I/R		05-09	23100-LBA2-E00 00127038			268216B
150	Grand Dink Euro 3		08-09	23100-KN7-671 00127985	268125		
Malaguti							
50	Centro 4T		08-10	41701400	268129L		
50	Centro SL 50		93-00	71700300	268127	268200	
50	Centro/SL/SL Cat.		93-00	71700300	268127	268200	

* Adaptable
* Adattabile

Les références du constructeur sont seulement indicatives et n'impliquent pas que les pièces de rechange viennent du constructeur.
I codici di riferimento originali sono indicativi e non implicano che i ricambi provengano necessariamente dalla stessa fabbrica del costruttore.

MOTEUR MOTORE COURROIE CINGHIA

CC	Modèle	Moteur	Année	Ref. OEM	BOOST™	BOOST™ +	BOOST™ DN
50	Ciak 2T/TD/Euro 2/Master/Rst		99-08	71700300	268127	268200	
50	Ciak Master 4T		05-09	41701400 480852	268129L		
50	F10 AC/AC ECO		08-09	59015000	268128A	268207	
50	F10 Kat./Rst/Euro 2		92-07	71700100	268128A	268207	
50	F12 Phantom/LC/Rst/Euro 2		94-06	71700300	268127	268200	
50	F12R Phantom AC		07-08	59015000	268128A	268207	
50	F12R Phantom LC		07-08	71701400 5RNE	268127	268200	
50	F15 Firefox		96-98	71700300	268127	268200	
50	F15 Firefox/LC/Rst/Euro 2		96-08	71700300	268127	268200	
50	Yesterday 50		97-...	71700100	268128A	268207	
100	Ciak		n/a	127319	268129L		
100	Ciak 2T		99-...	60330200	268129L		
100	F12 Phantom		n/a	127319	268129L		
100	F12 Phantom 2T		99-...	60330200	268129L		
125	Blog i.e.		09-10	35044800		268214	
125	Centro i.e.		07-08	65044800		268214	
125	F12 Phantom Max		03-...	71700900		268213	
125	F18 Warrior		01-...	51700300	268125		
125	Madison 125		99-...	71700700/00900		268213	
125	Madison Rst/Euro 2	Minare	99-05	71700700/00900		268213	
150	F18 Warrior		01-...	51700300	268125		
150	Madison T/R Rst/Euro 2		99-...	71700700/00900		268213	
160	Blog i.e.		09-10	65044800		268214	
160	Centro i.e.		07-10	65044800		268214	
180	Madison R 180		01-...	41700300/700			268216A
200	F12 Phantom Max		03-...	41700300/700			268216A
200	Madison S		02	41700300/700			268216A
200	Madison S Rst/Euro 2		03-...	41700300/700			268216A
250	F12 Phantom Max		04-...	41700900			268216G
250	Madison 3 IE Piaggio injection	Piaggio	06-09	41700900			268216G
250	Madison RS Piaggio carburator	Piaggio	04-05	41700900			268216G
250	Madison S	Yamaha	99-03	91700200		268215B	
500	Spider Max GT/Euro 3/RS		04-08	41701100			268216B
n/a	F10 jetline		n/a	n/a	268128A	268207	
n/a	SL		n/a	n/a	268127	268200	
Mbk							
50	Booster Road/Rocket/Track/NG		90-10	5RN-E7641-0000	268127	268200	
50	Booster Spirit/L/R/Naked/Euro 2		95-10	5RN-E7641-0000	268127	268200	
50	Booster X 4 Tempi		08-10	3B3-E7641-0000	268129	268202	
50	CR-Z Target		91-95	3WF-17641-10000	268128A	268207	
50	CT S/SS Sorriso		91-94	23Y-17641-0000			
50	CT SS New Sorriso		95-96	3GF-17641-0000	268128A	268207	
50	Evolis		92-95	3WF-17641-0000/3VP-17641-0000	268128A	268207	
50	Fizz		94-95	3WF-17641-0000/3VP-17641-0000	268128A	268207	
50	Flipper Euro 2		98-10	5RN-E7641-0000	268128A	268200	
50	Forte		94-96	3WF-17641-0000/3VP-17641-0000	268128A	268207	
50	Mach G/Euro 1/2		02-10	5RN-E7641-0000	268127	268200	
50	Nitro R/Cat./Euro 2/Naked		97-10	5RN-E7641-0000	268127	268200	
50	Ovetto 4 Tempi		09-10	5RN-E7641-0000	268127	268200	
50	Ovetto Euro 2 2 Tempi		97-10	5RN-E7641-0000	268127	268200	
50	Rocket		90-03	3AA-17641-0000	268127	268200	
50	Stunt/Naked		00-10	5RN-E7641-0000	268127	268200	
50	Target		91-95	3WF-17641-0000/3VP-17641-0000	268128A	268207	
125	Citycruiser		07-10	1B9-E7641-0000		268214	
125	Doodo		00-01	5DS-17641-0000		268213	
125	Flame F		00-03	4CW-17641-0200		268212	
125	K Flame R		96-99	4CW-17641-0200		268212	
125	Skycruiser		06-10	1B9-E7641-0000		268214	
125	Skyliner		99-10	5DS-17641-0000		268213	
125	T Flame		95-99	4CW-17641-0200		268212	
125	Thunder		01-02	5DS-17641-0000		268213	
150	Doodo		00-02	5DS-17641-0000		268213	
150	Skyliner		99-10	5DS-17641-0000		268213	
150	Thunder		01-02	5DS-17641-0000		268213	
180	Skyliner		03-08	5XM-E7641-0000			268216G
250	Skyliner		00-06	5CG-17641-0000		268215B	
n/a	Active		n/a	n/a	268128A	268207	
n/a	Equalis		n/a	n/a	268128A	268207	
n/a	Hot champ		n/a	n/a	268128A	268207	
n/a	Racing		n/a	n/a	268127	268200	
Peugeot							
50	Buxy/RS		94-97	729171/7551830	268128	268201	
50	Elyseo		97-...	729171/7551830	268128	268201	
50	Elystar		03-...	729171	268128	268201	
50	Elystar TSDI		03-...	729171	268128	268201	
50	Jet C-Tech		08-09	729171	268128	268201	
50	Jet Force		03-...	729171	268128	268201	
50	Looxor/TDSI		01-...	742470	268129L		
50	Ludix 2 Elegant		04-10	729171	268128	268201	
50	Ludix 2 One/Trend		04-09	729171	268128	268201	

CC	Modèle	Moteur	Année	Ref. OEM	BOOST™	BOOST™ +	BOOST™ DN
50	Ludix Classic/Elegant		04-09	729171	268128	268201	
50	Ludix One/Trend/Snake		04-09	729171	268128	268201	
50	Ludix SP Blaster/RS		05-09	729171	268128	268201	
50	Metal X		02-...	729171	268128	268201	
50	Metropolis		n/a	706490		268110	
50	New Vivacity 2T		07-09	729171	268128	268201	
50	SC Metropolis		91-...	706618		268110	
50	Speedake		95-97	729171	268128	268201	
50	Speedflight		n/a	729171/7551830	268128	268201	
50	Speedflight 2 Aria		05-08	729171/7551830	268128	268201	
50	Speedflight 2 LC/WRC/Silver S.		05-08	729171/7551830	268128	268201	
50	Speedflight 3/RS		08-09	729171/7551830	268128	268201	
50	Speedflight Aria/Acqua/Cat.		97-00	729171/7551830	268128	268201	
50	Squab		95-97	729171/7551830	268128	268201	
50	SV Geo		91-...	723590	268129C		
50	Trekker On road/Off road		98-...	729171/7551830	268128	268201	
50	TRK 2 WRC		05-09	729171/7551830	268128	268201	
50	Vivacity 2T		07-09	729171/7551830	268128	268201	
50	Vivacity/Cat./SX/SXR		99-06	729171	268128	268201	
50	X fight aria		00-...	729171/7551830	268128	268201	
50	X race		03-...	729171/7551830	268128	268201	
50	X-Fight		00-...	729171/7551830	268128	268201	
50	X-Race		03-...	729171	268128	268201	
50	Zenith LN/LS Luxe		94-...	723590	268129C		
80	SC LJ		n/a	706490		268110	
100	Elyseo		...-99	735947	268125		
100	Elyseo		00-...	740820	268129A		
100	Looxor		01-...	742527	268129B	268206	
100	Speedflight		00-...	740820	268129A		
100	Speedflight		97-99	735947	268125		
100	SV L Geo		98-99	735947	268125		
100	Trekker		98-99	735947	268125		
100	Trekker		00-...	740820	268129A		
100	Vivacity		...-99	735947	268125		
100	Vivacity		00-...	740820	268129A		
100	X-Fight		00-...	740820	268129A		
125	Elyseo		99-...	737830		268215	
125	Elystar		02-...	737830		268215	
125	Jet Force		03-...	737830		268215	
125	Sum Up		08-09	835-20-30	268129I	268217	
150	Elyseo		01-...	737830		268215	
150	Elystar		02-...	737830		268215	
250	Satelis Sat RS		06-09	n/a			268216G
400	Geopolis Geo RS		07-09	n/a			268216B
400	Satelis/Sat RS		07-09	n/a			268216B
500	Geopolis		07-09	n/a			268216B
500	Satelis		07-09	n/a			268216B
n/a	MTC 103 SPX		n/a	n/a		268110	
Pgo							
50	Big Max/Euro 2 2T		94-09	P1122000000		268209	
50	Dr. Big 2T		n/a	P1122000000		268209	
50	G-Max 2T		99-09	P1122000000		268209	
50	Hot Euro 2 2T		08-10	P1122000000		268209	
50	PMX Naked 2T		08-10	P1122000000		268209	
50	PMX Sport 2T		99-09	P1122000000		268209	
50	Tornado 2T		08-10	P1122000000		268209	
50	T-Rex 2T		99-09	P1122000000		268209	
250	G-Max		n/a	23100-KHE7-900 00127998		268209	
Piaggio							
50	*Diesis 2T		01-...	286162	268129G		
50	*Fly 2T		05-09	286162	268129G		
50	*Free/FL/Delivery		92-...	286162	268129G		
50	*Liberty 2T/Rst/Sport/PTT EU2/MOC		97-10	286162	268129G		
50	*NRG MC2/Extreme/MC3/ PureJet/Power/DD/DT		94-10	286162	268129G		
50	*NTT		95-96	286162	268129G		
50	*Quartz		92-96	286162	268129G		
50	*Sfera/Maquillage 2/FL Rst		91-97	286162	268129G		
50	*Typhoon XR		01-09	286162	268129G		
50	*Vespa ET2		97-05	286162	268129G		
50	*Vespa ET2 Injection		97-00	480341	268129B	268206	
50	*Vespa LX/LX FL 2T		05-08	286162	268129G		
50	*Vespa LXV/LXV Navy 2T		06-09	286162	268129G		
50	*Vespa S Special 2T		07-10	286162	268129G		
50	*Zip Base		92-96	286162	268129G		
50	*Zip Cat. 2T		00-09	286162	268129G		
50	*Zip Fast Rider/Rst		93-99	286162	268129G		
50	*Zip Rst		96-99	286162	268129G		
50	*Zip SP		96-00	286162	268129G		
50	Business		n/a	n/a	268129	268202	
50	Diesis 2T		01-...	436864	268129	268202	
50	Fly 2T		05-09	82712R	268129L		

MOTEUR MOTORE COURROIE CINGHIA

CC	Modèle	Moteur	Année	Ref. OEM	BOOST™	BOOST™ +	BOOST™ DN
50	Fly 4T		05-10	842907		268209	
50	Free		92-94	430728	268128A	268207	
50	Free Delivery		00-...	436864	268129	268202	
50	Free FL		95-01	430728	268128A	268207	
50	Free FL		02-...	436864	268129	268202	
50	Liberty 2T		06-10	82712R	268129L		
50	Liberty 2T		97-05	480852/82712R	268129L		
50	Liberty 2T MOC		09-10	82712R	268129L		
50	Liberty 2T PTT EU2		04-06	82712R	268129L		
50	Liberty 2T Rst		04-06	82712R	268129L		
50	Liberty 2T Sport		06-08	82712R	268129L		
50	Liberty 4T		n/a	478954/828223	268129H	268203	
50	Liberty 4T		00-03	480852/82712R	268129L		
50	Liberty 4T MOC		09-10	82712R	268129L		
50	Liberty 4T Rst		04-10	82712R	268129L		
50	Liberty 4T Sport		06-07	82712R	268129L		
50	Liberty 4T Sport Euro 3		07-10	82712R	268129L		
50	Liberty 50 le 4t		01-...	480852/82712R	268129L		
50	NRG		94-96	430728	268128A	268207	
50	NRG Extreme		99-01	436864	268129	268202	
50	NRG MC		n/a	436864/286162	268129	268202	
50	NRG MC2		94-97	430728	268128A	268207	
50	NRG MC3		01-04	436864	268129	268202	
50	NRG Power DD		05-10	436864	268129	268202	
50	NRG Power DT		06-10	436864	268129	268202	
50	NRG Power PureJet		04-05	833982	268129	268202	
50	NRG PureJet		02-04	436864	268129	268202	
50	NRG Rst MC2 DD		98	436864	268129	268202	
50	NRG Rst MC2 DT		96-97	430728	268128A	268207	
50	NTT		95-96	430728	268128A	268207	
50	Quartz		92-96	431190/289432	268129G		
50	Runner 50		n/a	n/a	268121	268215	
50	Sfera		91-93	286175	268128B		
50	Sfera FL Rst		95-97	431190	268129G		
50	Sfera II		n/a	286162	268129G		
50	Sfera Maquillage 2		...94	431190	268129G		
50	Typhoon		01-...	436864	268129	268202	
50	Typhoon X		01-...	436864	268129	268202	
50	Typhoon XR		01-09	436864	268129	268202	
50	Vespa ET2		97-04	431190	268129G		
50	Vespa ET2		98-05	828223/82645R	268129H	268203	
50	Vespa ET2 Injection		98-00	480135	268129B	268206	
50	Vespa ET2 Injection		97-00	828223/82645R	268129H	268203	
50	Vespa ET4		00-05	828223/82645R	268129H	268203	
50	Vespa LX 2T		05-09	828223/82645R	268129H	268203	
50	Vespa LX 4T		05-09	82645R	268129H	268203	
50	Vespa LX 4T-4V		05-09	82645R	268129H	268203	
50	Vespa LX FL 2T		09-10	82645R	268129H	268203	
50	Vespa LX FL 4T		09-10	82645R	268129H	268203	
50	Vespa LXV 2T		06-09	82645R	268129H	268203	
50	Vespa LXV Navy 2T		08-09	82645R	268129H	268203	
50	Vespa S Special 2T		07-10	82645R	268129H	268203	
50	Vespa S Special 4T-4V		08-10	82645R	268129H	268203	
50	XR		n/a	n/a	268129	268203	
50	Zip 2000 SP		n/a	n/a	268129H	268203	
50	Zip 4T		00-08	828223/82645R	268129H	268203	
50	Zip Base		95-96	431190	268129G		
50	Zip Base		92-94	286175	268128B		
50	Zip Base/FD		92-95	286175	268128B		
50	Zip Cat. 2T		00-09	828223/82645R	268129H	268203	
50	Zip Fast/Rider/Rst		93-99	431190	268129G		
50	Zip Rst		96-99	431190	268129G		
50	Zip SP		96-00	431190	268129G		
50	Zip SP		01-10	828223/82645R	268129H	268203	
80	Sfera		99-...	430719	268128B		
80	Skr city		99-...	430719	268128B		
100	Diesis 2T		00-01	00G02606371	268129B	268206	
100	Zip 4T		06-10	82645R	268129H	268203	
125	*Hexagon 2T/LX 2T		94-99	431370		268213	
125	*Skipper 2T/LX 2T		93-99	431370		268213	
125	Hexagon 2T		94-97	431370		268211	
125	Hexagon LX 2T		98-99	434812		268213	
125	Hexagon LX4 4T		98-...	484758	268129B	268206	
125	Liberty		98-99	484758	268129B	268206	
125	Liberty		00	825059	268129B	268206	
125	Sfera 4T		n/a	4348072		268209	
125	Sfera ET4		n/a	4348072		268209	
125	Sfera FL 4T		95-97	434807/478547	268129H	268203	
125	Skipper 2T Frame nr. from 14741		93-97	434812		268213	
125	Skipper 2T Frame nr. till 14740		95-97	431258		268211	
125	Skipper LX 2T		98-99	434812		268213	
125	Typhoon		n/a	n/a		268213	

CC	Modèle	Moteur	Année	Ref. OEM	BOOST™	BOOST™ +	BOOST™ DN
125	Vespa ET4		97-99	434807/478547	268129H	268203	
125	Vespa ET4	Leader	00-05	832023/841213		268210	
125	Vespa GT GranTurismo/Euro 3		03-08	832023/841213		268210	
125	Vespa GTS Euro 3		07-09	841213		268210	
125	Vespa GTS Super i.e.		09-10	841213		268210	
125	Vespa GTV Euro 3		07-08	841213		268210	
125	Vespa GTV Navy Euro 3		08-09	841213		268210	
125	Vespa LX Euro 3		05-08	841213		268210	
125	Vespa LX FL		09-10	841213		268210	
125	Vespa LX i.e.		09-10	841213		268210	
125	Vespa LXV Euro 3		06-10	841213		268210	
125	Vespa LXV i.e.		10	841213		268210	
125	Vespa LXV Navy Euro 3		08-09	841213		268210	
125	Vespa S Special Euro 3		07-10	841213		268210	
125	Vespa S Special i.e.		09-10	841213		268210	
125	X 7 Euro 3		08-10	841213		268210	
125	X 7 EVO i.e.		09-10	841213		268210	
125	X 8 Premium Euro 2/Euro 3		04-07	841213		268210	
125	X 8 Street Euro		06-07	841213		268210	
125	X 9 Evolution Euro 3		01-08	832023/841213		268210	
125	X-EVO		07-10	841213		268210	
125	Zip 4T		00-06	832023/841213		268210	
150	*Hexagon 2T		94-97	431370		268213	
150	*Skipper 2T/LX 2T		93-99	431370		268213	
150	Hexagon 2T		94-97	434812		268213	
150	Sfera ET4		n/a	4348072		268209	
150	Skipper 2T Frame nr. from 14741		93-97	434812		268213	
150	Skipper 2T Frame nr. till 14740		93-97	431258		268211	
150	Skipper LX 2T		98-99	434812		268213	
150	Skipper LX 2T		98-99	434812		268213	
180	*Hexagon LXT 2T		98-99	431370		268213	
180	Hexagon GTX 4T		00	827639/832623			268216A
180	Hexagon LXT 2T		98-99	484497		268211	
180	Super Hexagon GTX 4T		01-...	827639/832623			268216A
180	X 9 Amalfi		00-03	827639/832623/840908			268216A
200	Liberty Rst/Euro 3		04-09	840908			268216A
200	Liberty Sport/Euro 3		06-09	840908			268216A
200	Vespa GT GranTurismo		03-09	840908			268216A
200	Vespa GT L		03	840908			268216A
200	X 8		04-06	840908			268216A
200	X 9 Evolution		02-04	833578/840908			268216A
250	Hexagon GT		98-99	495158		268211	
250	MP3		06-08	82941R/843963			268216G
250	MP3 LT		09-10	82941R/843963			268216G
250	MP3 MIC		08-10	82941R/843963			268216G
250	Super Hexagon GTX		00-...	495158		268211	
250	Vespa GT60 Euro 3		06-08	82941R/843963			268216G
250	Vespa GTS/ABS		05-10	82941R/843963			268216G
250	Vespa GTV		06-10	82941R/843963			268216G
250	Vespa GTV Navy		08-09	82941R/843963			268216G
250	X 7		07-10	82941R/843963			268216G
250	X 8		05-08	82941R/843963			268216G
250	X 9 Evolution		04-07	843963			268216G
250	X-EVO		07-10	843963			268216G
400	Beverly Euro 3		06-08	832738			268216B
400	Beverly i.e.		06-08	832738			268216B
400	Beverly Tourer Euro 3		08-10	832738			268216B
400	MP3		07-08	832738			268216B
400	MP3 LT		09-10	832738			268216B
400	MP3 MIC		08-10	832738			268216B
400	X8		06-08	832738			268216B
400	X-EVO		07-10	832738			268216B
500	Beverly		02-06	832738			268216B
500	Beverly Cruiser		07-08	832738			268216B
500	Beverly Euro 3		06-08	832738			268216B
500	X 9 Evolution/ABS		03-08	832738			268216B
Rieju							
50	Paseo 4T		07-08	n/a	268129E		
50	Toreo 4T		07-08	n/a	268128B		
n/a	Crosser		n/a	n/a	268127	268200	
n/a	First		n/a	n/a	268127	268200	
n/a	Windy		n/a	n/a	268127	268200	
Sachs							
50	49ER 4T 10+		05-06	n/a	268129E		
50	49ER 4T 12+		07-08	n/a	268128B		
50	Bee 4T		07-08	n/a	268129E		
125	Bee 4T		07-08	n/a	268129L	268217	
125	Eagle 4T		07-08	n/a	268129L	268217	
Suzuki							
50	AH Address		92-95	27601-09E00/27601-0400300	268129E		
50	AJ ZZ Sepia S		95-97	27601-25E00	268129E		

* Adaptable
* Adattabile

Les références du constructeur sont seulement indicatives et n'impliquent pas que les pièces de rechange viennent du constructeur.
I codici di riferimento originali sono indicativi e non implicano che i ricambi provengano necessariamente dalla stessa fabbrica del costruttore.

MOTEUR MOTORE COURROIE CINGHIA

CC	Modèle	Moteur	Année	Ref. OEM	BOOST™	BOOST™ +	BOOST™ DN
50	AP R/S		94-95	27601-09E00/27601-04C0300	268129E		
50	AP T/V		96-97	27601-010E00	268129A		
50	AY Katana Air air		03-04	27601-10E00	268129A		
50	AY Katana/W/WR air/water		97-98	27601-10E00	268129A		
50	CP Lido		91-94	27601-03A02	268129E		
50	Seppia ZZ/AJ/Tune		n/a	27601-25E00	268129E		
100	AH Address		93-95	27601-09E00/27601-04C0300	268129E		
125	UC Epicuro		02-06	27601-21F11		268211	
125	UH Burgman		07-10	27601-03H00		268211	
125	UH Burgman		02-06	27601-21F11		268211	
125	VC Epicuro		n/a	n/a		268213	
150	UC Epicuro		98-...	27601-21F00		268211	
150	UH Burgman		02-06	27601-21F11		268211	
150	VC Epicuro		n/a	n/a		268213	
400	AN Burgman X/K2		98-02	27601-15F03			268216E
400	AN Burgman IE K3/K6		03-06	27601-15F10			268216E
400	AN Burgman IE K7/K8		06-08	27601-05H00			268216I
Sym							
50	Cinderella 50		99-02	1B01GAK01	268129E		
50	Euro X Eu 2/Sport X		99-07	1B01T5201		268209	
50	Fiddle		n/a	1B01GAK01	268129E		
50	Fiddle II		08	1B01BE201	268129G		
50	Fiddle II S		09-10	1B01AMA01	268128	268201	
50	Jet		n/a	23100-T52-0000		268209	
50	Jungle		99-00	1B01T5201/23100-T52-0000		268209	
50	Mask Euro 2		00-04	1B01T5201/23100-T52-0000		268209	
50	Red Devil		99-...	1B01T5201/23100-T52-0000		268209	
50	RS		07-...	1B01T5201/23100-T52-0000		268209	
50	Super Fancy		98-00	1B01GAK01	268129E		
50	Symphony		09-10	1B01AMA01	268128	268201	
50	Symply		08	1B01BE201	268129G		
50	Symply II		09-10	1B01AMA01	268128	268201	
100	Mio 4T Euro 2/Euro 3		05-10	1B01A3G01	268129H	268203	
125	Fiddle II		07-10	1B01KN701	268125		
125	Joyride Eu 2		01-04	1B01H9A01	268129I	268217	
125	New Duke		00-01	1B01GY601	268129J		
125	RV Foreign		01-04	1B01H9A01	268129I	268217	
125	Super Duke		99-02	1B01GY601	268129J		
125	Symply		07-09	1B01KN701	268125		
150	Joyride		01-02	1B01H9A01	268129I	268217	
150	RV Foreign		01-02	1B01H9A01	268129I	268217	
180	RV Foreign		03-06	1B01H9A01	268129I	268217	
200	GTS Foreign		03-06	1B01H9A01	268129I	268217	
200	Joyride Eu 2/Euro 2		03-06	1B01H9A01	268129I	268217	
Tgb							
50	101 S		04-05	GE506RB01	268126		
50	Arkoss TEC		n/a	GE506RB01	268126		
50	BH1 C 101R		n/a	GE506RB01	268126		
50	BM1		n/a	GE506RB01	268126		
50	BR1 303/R/RS		n/a	GE506RB01	268126		
50	BR1D		n/a	GE506RB01	268126		
50	BT-QT		n/a	GE506RB01	268126		
50	Cobra		n/a	GE506RB01	268126		
50	Delivery		04-09	GE506RB01	268126		
50	Key West		06-09	GE506RB01	268126		
50	Laser/R5/R5 i		04-09	GE506RB01	268126		
50	R-X Jet fighter		06-09	GE506RB01	268126		
50	Sunset		07-08	GE506RB01	268126		
125	F409 Sienna		03-09	906-22,5-30		268214	
125	Scooter motore bh2		n/a	743-20-30	268129J		
150	F409 Sienna		03-09	906-22,5-30		268214	
150	Scooter motore bh2		n/a	743-20-30	268129J		
Yamaha							
50	Aerox Max		n/a	n/a	268127	268200	
50	Aerox R		97-01	5RN-E7641-00	268127	268200	
50	Axis		n/a	3VP-17641-00/3KJ-17641-0000	268128A	268207	
50	Breeze		n/a	3VP-17641-00	268128A	268207	
50	BW'S		04-10	5RN-E7641-00	268127	268200	
50	BW'S Bump		97-98	5RN-E7641-00	268127	268200	
50	BW'S Naked		03-04	5RN-E7641-00	268127	268200	
50	BW'S Naked		09-10	5RN-E7641-00	268127	268200	
50	BW'S Next Generation/Cat.		97-08	5RN-E7641-00	268127	268200	
50	BW'S Original/Euro 2		97-08	5RN-E7641-00	268127	268200	
50	BW'S R		01-03	5RN-E7641-00	268127	268200	
50	CR Z		91-95	3WF-17641-00	268128A	268207	
50	CR50		n/a	3VP-17641-00	268128A	268207	
50	CS Jog R/Euro 2		02-10	5RN-E7641-00	268127	268200	
50	CW BW'S Original Euro 2/SP		02	5RN-E7641-00	268127	268200	

CC	Modèle	Moteur	Année	Ref. OEM	BOOST™	BOOST™ +	BOOST™ DN
50	CW L BW'S		03-04	5RN-E7641-00	268127	268200	
50	CW RS Spy		95-98	5RN-E7641-00	268127	268200	
50	EW Slider		00-02	5RN-E7641-00	268127	268200	
50	Jog		n/a	3KJ-17641-0000	268128A	268207	
50	Jog R		n/a	3KJ-17641-0000	268128A	268207	
50	Jog Z		n/a	3VP-17641-00	268128A	268207	
50	Neo		02-03	n/a	268127	268200	
50	Slider		00-...	5RN-E7641-00	268127	268200	
50	Why		99-00	5RN-E7641-00	268127	268200	
50	XF Giggle 4T		08-10	3B3-E7641-0000	268129	268202	
50	YA R Axis		95-95	3WF-17641-00	268128A	268207	
50	YH Why/Euro 1/2		98-10	5RN-E7641-00	268127	268200	
50	YM Breeze		94-95	3WF-17641-00	268128A	268207	
50	YN Neo's 2T/R/Euro 2		97-10	5RN-E7641-00	268127	268200	
50	YN Neo's 4 4T		09-10	5C3-E7641-0000	268127	268200	
50	YQ Aerox/LJR/Euro 2		97-10	5RN-E7641-00	268127	268200	
50	ZA Jog Z		95-96	3WF-17641-00	268128A	268207	
80	Active		n/a	n/a	268128A	268207	
80	Zest		n/a	n/a	268128A	268207	
90	Jog		n/a	n/a	268129A		
100	Ovetto		n/a	n/a	268127	268200	
125	VP X-City		07-08	1B9-E7641-00		268214	
125	XC Cygnus		n/a	4CW-17641-00	268126		
125	XC Cygnus R		n/a	4CW-17641-00	268126		
125	XC Cygnus R		99-03	4CW-17641-02		268212	
125	XC K Cygnus		97-98	4CW-17641-02		268212	
125	XC T Cygnus		95-98	4CW-17641-02		268212	
125	XN Teo's		00-02	5DS-17641-00		268213	
125	XQ Maxster		01-02	5DS-17641-00		268213	
125	YP Majesty		n/a	5CA-17641-0000			268216A
125	YP Majesty		99-02	5DS-17641-00		268213	
125	YP Majesty E		03-10	5NS-E7641-1-00		268213	
125	YP R X-Max		06-10	1B9-E7641-00		268214	
150	XC Flyone/R		90-98	3UH-17641-00			
150	XN Teo's		00-02	5DS-17641-00		268213	
150	XQ Maxster		01-02	5DS-17641-00		268213	
150	YP Majesty		00-03	5DS-17641-00		268213	
180	YP Majesty E		03-08	5XM-E7641-00			268216G
250	Skyliner		n/a	n/a		268215B	
250	YP Majesty		96-98	4HC-17641-0000		268215B	
250	YP Majesty/DX/ABS		98-06	5CG-17641-0000		268215B	
250	YP R X-Max/ie/Black X-Max		05-10	5SE-E7641-0200		268216J	
300	VP Versity/XC		03-08	5SE-E7641-0100		268216J	
400	YP Majesty		04-06	5RU-17641-0000			268216D
400	YP Majesty		07-08	5RU-17641-1000			268216D
500	XP T-Max ie/Black Max		04-07	5VU-17641-0000			268216
500	XP T-Max/ABS		08-10	5VU-17641-0000			268216
530	XP T-Max/ABS		12-15	59C-17641-0000			268216K

POULIE PULEGGIA

TNT
Original



POULIE *PEUGEOT 103
S542504 PLASTIQUE AVEC PIGNON 11D
S2505 PLASTIQUE SANS PIGNON



POULIE *MBK 51
S53521 PIGNON SOUDÉ



BOOST™

BOOST™ SCOOTER

avec mélange en caoutchouc renforcé d'aramide afin d'améliorer la durabilité

BOOST™ + SCOOTER KEVLAR

avec mélange en caoutchouc renforcé d'aramide et cordes de traction en aramide extra résistantes afin de maximiser accélération, résistance aux chocs et durée de vie

BOOST™ DN MAXISCOOTER

avec mélange EPDM avancé, cordes de traction en aramide extra résistantes et une construction double face (Double Notch) afin d'assurer une performance extrêmement élevée et particulièrement adaptée aux types de véhicules de haute capacité

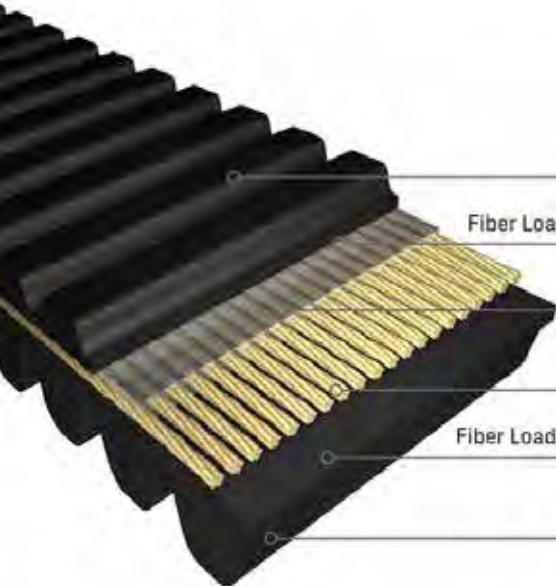

Top Fabric/ Revêtement

Fiber Loaded Rubber/ Caoutchouc renforcé de fibres

Adhesion Gum/ Gomme adhésive

Tensile Cord/ Corde de traction

Fiber Loaded Rubber/ Caoutchouc renforcé de fibres

Cog Jacket/ Revêtement des dents



MOTEUR MOTORE

FILTRE A HUILE FILTRO OLIO

TNT
Original

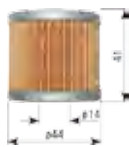

***SUZUKI BURGMAN 125 - 400CC**
623000 OEM : 16510-05240-000



***SUZUKI BURGMAN 250 / 400CC**
623000G OEM : 16510-25C00-000



***SUZUKI BURGMAN 650CC**
623000H OEM : 16510-06B00 / 16510-03G00 / 16510-34E00



***SUZUKI GS 500 (88-02)**
623000A



***YAMAHA FLAMME / SKYLINER / CYGNUS 125CC**
623000C OEM : 5H0-13440-00/09 / 3UH-E3340-00



***YAMAHA TMAX 500 / 530CC**
623000D OEM : 5DM13440000 / KYMCO 1541A-LAB2-E00



***YAMAHA XMAX / XCITY / YZFR 125CC**
623000J OEM : 5YP-E34400-00 / 5TG / 5TA-13440-00



***YAMAHA MAJESTY 400CC**
623000L OEM : 16510-24501



***PEUGEOT ELYSEO 125 / SATELIS 125CC**
623000I OEM : 0256451 / 0256450 / 020450 / BMW 11417651414



***KYMCO DINK 125-150-200CC**
623000N OEM : 1541A-KKC3-9000 / 00124759



***KYMCO DOWNTOWN 300i / K-XCT 125 / 300CC**
623000O OEM : 1541A-LEA7-E00 / 00115058

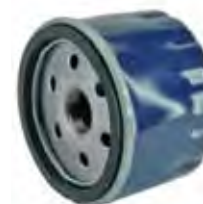

***SCARABEO / X9 500 / MP3 400 / 500CC / GP 800 / FUOCO 500CC**
623000A OEM : 82658R / 830239 / 82883R



***HONDA SH 300 / SILVERWING 400 - 600 / 700 INTEGRA**
623000M OEM : 15410-MCJ-000 / 003 / 505



***GILERA RUNNER / PIAGGIO VX / X8 / X9 125CC**
623000F OEM : 82635R / 483727



***BMW C600 / C650 GT**
623000P

MOTEUR MOTORE

FILTRE A HUILE FILTRO OLIO

TNT
Original

Modèle Modello	Cyl. Cil.	Année Anno	Réf. Codice
-------------------	--------------	---------------	----------------

APRILIA			
Atlantic	125	02-11	623000F
Atlantic	200	03-11	623000F
Atlantic	250	04-06	623000F
Atlantic	300	10-11	623000F
Atlantic	400	06-08	623000A
Atlantic	500	02-11	623000A
Atlantic i.e.	250	06-09	623000F
Léonardo	125	96-05	623000I
Scarabéo	400	06-10	623000A
Scarabéo	500	02-11	623000A
Scarabéo GT Moteur Piaggio	125	03-07	623000F
Scarabéo GT Moteur Piaggio	250	03-05	623000F
Scarabéo GT Moteur Rotax	125	99-03	623000I
Scarabéo i.e.	250	06-11	623000F
Scarabéo Light Spécial	300	09-11	623000F

BENELLI			
Adiva	125	00-03	623000F
Adiva	250	06-08	623000F

BMW			
C600	600		623000P
C650 GT	650		623000P

DERBI			
Boulevard	125	02-09	623000F
Boulevard	150	02-09	623000F
Gp1 E2	125	06-09	623000F
Low Seat E3	125	06-09	623000F
Rambla	125	08-09	623000F

GILERA			
Dna	125	01-03	623000F
Dna	180	01-03	623000F
Fuoco	500	07-12	623000A
Gp	800	08-12	623000A
Nexus	125	07-08	623000F
Nexus	250	06-08	623000F
Nexus	500	08-12	623000A
Runner VX VXR	125	01-08	623000F
Runner VX VXR	200	03-08	623000F
Runner VXR	180	01-08	623000F

HONDA			
FJS Silwer Wing	400	06-09	623000M
FJS Silwer Wing	600	01-04	623000M
FJS Silwer Wing ABS	600	03-10	623000M
FJS SW-T	400	09-10	623000M
NS Forza	250	08-10	623000M
SH i ABS	300	07-10	623000M

ITALJET			
Jet Set	125	01-03	623000F
Torpedo Moteur Leader	125	02-03	623000F

MALAGUTI			
F12 Phantom Max	200	04-05	623000F
F12 Phantom Max	250	04-05	623000F
Madison	125	06-08	623000F
Madison	180	01-02	623000F
Madison	200	02-03	623000F
Madison S,RS, ie	250	04-08	623000F
SpiderMax	500	04-10	623000A

MBK			
Citycruiser	125	07-09	623000J
Skycruiser	125	06-09	623000J

PEUGEOT			
Elyseo	125	99-04	623000I
Elyseo	150	01-03	623000I
Elystar	125	03-04	623000I
Elystar	150	03-04	623000I
Geopolis	125	07-09	623000I
Geopolis	250	07	623000F
Geopolis	400	07-11	623000A
Jet Force	125	03-04	623000I
Looxor	125	03-04	623000F

Modèle Modello	Cyl. Cil.	Année Anno	Réf. Codice
-------------------	--------------	---------------	----------------

Looxor	150	03-04	623000F
Satelis	125	06-09	623000I
Satelis	250	07-09	623000F
Satelis	400	07-09	623000A
Satelis	500	07-11	623000A

PIAGGIO			
Beverly	125	01-03	623000F
Beverly Cruiser	500	03-09	623000A
Beverly GT	125	01-10	623000F
Beverly GT	200	01-03	623000F
Beverly GT,RST,ie,Cruiser,Tourer	250	04-09	623000F
Beverly i.e.	400	06-08	623000A
Beverly Tourer	400	08-09	623000A
Carnaby	125	07-10	623000F
Carnaby	200	07-09	623000F
Carnaby ie	250	08-09	623000F
Fly	125	05-10	623000F
GTX Super Hexagon	125	01-03	623000F
Liberty	150	99-03	623000F
Liberty Delivery	125	08-09	623000F
Liberty MOC	125	09-10	623000F
Liberty MOC	150	09-10	623000F
Liberty Moteur Leader	125	00-03	623000F
Liberty Sport	150	08-09	623000F
Liberty Sport,RST	200	04-09	623000F
Liberty Sport,RST,PTT	125	04-11	623000F
MP3	125	07-08	623000F
MP3	250	06-10	623000F
MP3	400	07-08	623000A
MP3 ie, Hybrid	125		623000F
MP3 MIC /LT	400	08-10	623000A
Skipper ST	125	00-05	623000F
Vespa ET4	125	00-10	623000F
Vespa ET4	150	00-05	623000F
Vespa GT	200	04-09	623000F
Vespa GT,GTS,GTV	250	05-10	623000F
Vespa ie	150	08-10	623000F
Vespa LX	150	05-10	623000F
Vespa LX,LXV	125	05-10	623000F
Vespa S,Special	125	07-10	623000F
X7	125	08-10	623000F
X7	250	08-09	623000F
X8	125	05-07	623000F
X8	200	05-06	623000F
X8	250	05-10	623000F
X8	400	06-08	623000A
X9	125	01-03	623000F
X9	200	02-03	623000F
X9	500	02-03	623000A
X9 Evolution	125	04-07	623000F
X9 Evolution	200	03-04	623000F
X9 Evolution	250	04-07	623000F
X9 Evolution	500	03-09	623000A
X9 SL	125	03	623000F
X-Evo	125	07-08	623000F
X-Evo	250	07-08	623000F
X-Evo	400	07-08	623000A
Zip	125	02-06	623000F

SUZUKI			
AN	125	96-01	
Burgman AN	250	99-07	623000G OU 623000L
Burgman AN	400	99-06	623000G OU 623000L
Burgman AN	650	02-08	623000H

YAMAHA			
VP 125 X-City	125	07-11	623000J
X-Max	125	06-10	623000J
X-Max ie EURO 3	400		623000G OU 623000L
XP 500 T-Max	500	01-11	623000D
XP 530 T-Max	530	12	623000D
YP 250 Majesty	250	04-07	623000G OU 623000L
YP 400 Majesty	400	04-12	623000G OU 623000L



BOUCHON DE VIDANGE
TAPPO DI SCARICO
***HONDA / KYMCO / PIAGGIO 4T**
***GY6 50 & 125**
623000K

* Adaptable
* Adattabile

Les références du constructeur sont seulement indicatives et n'impliquent pas que les pièces de rechange viennent du constructeur.
I codici di riferimento originali sono indicativi e non implicano che i ricambi provengano necessariamente dalla stessa fabbrica del costruttore.

AS 75

MOTEUR MOTORE CARBURATEUR CARBURATORE

> DELL'ORTO SHA



SHA 13/13
110150



SHA 14/12 L
110209



SHA 15/15
110210



SHA 16/16
110212

SHA	PRINCIPAL PRINCIPALE	STARTER STARTER	BOISSEAU GHIGLIOTTINA
110150	SHA 13/13	66	LEVIER LEVER
110209	SHA 14/12L	57	LEVIER LEVER
110210	SHA 15/15C	68	CABLE CABLE
110212	SHA 16/16	70	CABLE CABLE

A GICLEUR ZIGLORE

PHBG / SHA 05

	N°
130050	50
130052	52
130055	55
130058	58
130060	60
130062	62
130065	65
130068	68
130070	70
130072	72
130075	75
130078	78
130080	80
130082	82
130085	85
130088	88
130090	90
130092	92
130095	95
130098	98
130100	100
130102	102
130105	105
130108	108
130110	110
130115	115
130116	118
130117	120
130118	122
130119	124
130120	128
130121	130
130122	132
130123	135
130124	138
130125	140
130126	142
130127	145
130128	150

PIECES PEZZI

SHA	
122838	ARRET ESSENCE POINTEAU SHA
	SPILLO GALLEGGIANTE SHA
129249	ARRIVEE ESSENCE SHA 15/15
	TUBO ARRIVO BENZINA SHA 15/15
120146	BAGUE SHA 15/15 ITALIE
	BOCCOLA SHA 15/15 ITALIE
126108	BOISSEAU SHA 15/15
	GHIGLIOTTINA SHA 15/15
126110	COUVERCLE DE BOISSEAU SHA 15/15
	COPERCHIO GHIGLIOTTINA SHA 15/15
123412	CUVE SHA 15/15
	VASCHETTA SHA 15/15
127427	ECROU SERRAGE COLLIER SHA 15/15
	DADO SERRAGGIO FASCETTA SHA 15/15
121692	ECROU DE TENDEUR SHA
	DADO TENDITORE SHA
126109	FILTRE ESSENCE SHA 15/15
	FILTRO BENZINA SHA 15/15
126122	FLOTTEUR SHA 15/15
	GALLEGGIANTE SHA 15/15
126111	JOINT DE COUVER. BOISSEAU SHA 15/15
	GALLEGGIANTE SHA 15/15
126123	JOINT DE CUVE SHA 15/15
	GUARN. VASCHETTA SHA 15/15
125253	POCHETT JOINTS 52533 SHA
	KIT GUARN.S 52533 SHA
121476	PROTEGE GAINA SHA
	PROTEGGI GUAINA SHA
123346	RESSORT DE BOISSEAU SHA
	MOLLA GHIGLIOTTINA SHA
123606	RESSORT VIS RALENTI SHA
	MOLLA VITI MINIMO SHA
121481	TENDEUR DE GAINA SHA
	TENDITORE GUAINA SHA
121481A	TENDEUR DE GAINE DROIT SHA
	TENDITORE GUAINA DESTRO SHA
123698	TUBE COUDE SHA
	TUBO CURVO SHA
123598	VIS DE CUVE SHA
	VITI VASCHETTA SHA
126140	VIS DE RALENTI SHA 15/15
	VITI MINIMO SHA 15/15
126305	VIS SERRAGE COLLIER SHA 15/15
	VITI SERRAGGIO FASCETTA SHA 15/15

SHA 14/12
SHA 15/15
SHA 16/16



TNT
Original



FILTRE FILTRO
114000 DELL'ORTO SHA

MOTEUR MOTORE CARBURATEUR CARBURATORE

> DELL'ORTO PHBN



PHBN 12 HS
110292 *BOOSTER > 2004



PHBN 16 FS
110215



PHBN 16 NS
110215A



PHBN 17,5 LS
110216

PHBN	PRINCIPAL PRINCIPALE	RALENTI MINIMO	STARTER STARTER	AIGUILLE SPILLO	DIFFUSEUR DIFFUSORE
110292 PHBN 12 HS BOOSTER >2004	93	36	40	A21	GA211
110215 PHBN 16 FS	72	34	50	A21	FA210
110215A PHBN 16 NS	72	34	50	A21	FA210
110216 PHBN 17,5 LS	90	34	50	A21	GA214

A GICLEUR ZIGLORE

PHVA / PHBN / PHBL / PHBH VHST / PHVB

	N°
130256	56
130271	60
130271A	62
130271B	65
130271C	68
130271D	70
130272	72
130275	75
130278	78
130280	80
130285	85
130290	90
130295	95
S427683	98
131100	100
131105	105
131110	110
131115	115
S427691	118
131120	120
S427693	122
131125	125
131130	130
131135	135
131140	140
S427696	145

PIECES PEZZI

PHBN

129807	AIGUILLE PHBN 17,5
	SPILLO PHBN 17,5
129804	BOISSEAU PHBN 16
	GHIGLIOTTINA PHBN 16
129805	BOISSEAU PHBN 17,5
	GHIGLIOTTINA PHBN 17,5
129914	CLIPS BOISSEAU PHBN
	CLIPS GHIGLIOTTINA PHBN
129800	COUVERCLE BOISSEAU PHBN 16
	COPERCHIO GHIGLIOTTINA PHBN 16
129801	COUVERCLE BOISSEAU PHBN 17,5
	COPERCHIO GHIGLIOTTINA PHBN 17,5
129920	COUVERCLE STARTER PHBN
	COPERCHIO STARTER PHBN
129900	COUVERCLE BOISSEAU COUDE PHBN
	COPERCHIO GHIGLIOTTINA CURVO PHBN
129915	CUVE PHBN
	VASCHETTA PHBN
129820	DIFFUSEUR PHBN 16
	DIFFUSORE PHBN 16
129821	DIFFUSEUR PHBN 17,5
	DIFFUSORE PHBN 17,5
129906	FLOTTEUR+ARRET ESSENCE POINTEAU PHBN
	GALLEGGIANTE PHBN
129835	GICLEUR DE STARTER D.45 PHBN
	ZIGLORE STARTER D.45 PHBN
129836	GICLEUR DE STARTER D.50 PHBN
	ZIGLORE STARTER D.50 PHBN
129912	JOINT COUVERCLE BOISSEAU PHBN
	GUARN. COPERCHIO GHIGLIOTTINA PHBN
129917	JOINT DE CUVE PHBN
	GUARN. VASCHETTA PHBN
129802	RESSORT BOISSEAU PHBN 16
	MOLLA GHIGLIOTTINA PHBN 16
129803	RESSORT BOISSEAU PHBN 17,5
	MOLLA GHIGLIOTTINA PHBN 17,5
129916	VIS DE CUVE PHBN
	VITI VASCHETTA PHBN
129922	VIS AIR PHBN
	VITI ARIA PHBN
129923	VIS RALENTI PHBN
	VITI MINIMO PHBN

B GICLEUR RALENTI ZIGLORE MINIMO

PHVA / PHBN	N°
129832	32
129830	34
129831	38
129833	40
129833A	42

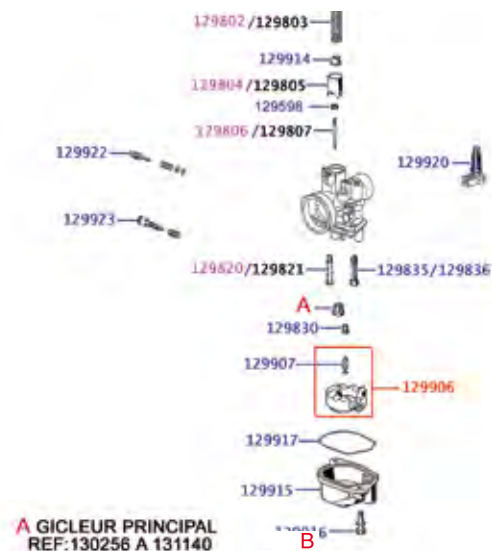

TNT
Original

AIGUILLES SPILLI PHBN/PHVA 12-17,5mm
S5814A COFFRET 10 AIGUILLES COFANETTO 10 SPILLI
A2-A7-A8-A12-A13-A20-A21-A26
A28-A33

MOTEUR MOTORE CARBURATEUR CARBURATORE

> DELL ORTO PHBG Bride (Innesto Femmina Brida de Apriete)



PHBG 17,5 AD
110220



PHBG 19 CS
110285



PHBG 19,5 AD
110230



PHBG 21 AD
110235



PHBG 21 CS
110238

> DELL ORTO PHBG



PHBG 17 DD
110286



PHBG 19 DS
110229



PHBG 19 DD
110287



PHBG 21 BS
110280



PHBG 21 BD
110236



PHBG 21 DS
110237

> DELL ORTO PHBG RACING



PHBG 19 RACING
110229A



PHBG 21 RACING
110235A

MOTEUR MOTORE CARBURATEUR CARBURATORE

> DELL'ORTO PHBG



PHBG	PRINCIPAL PRINCIPALE	RALENTI MINIMO	STARTER STARTER	AIGUILLE SPILLO	DIFFUSEUR DIFFUSORE
110286	PHBG 17 DD	70	45	65	W16 AN 262
110220	PHBG 17,5 AD	82	55	55	W9 AN 262
110285	PHBG 19 CS	75	45	60	W9 AN 262
110229	PHBG 19 DS	75	45	60	W9 AN 262
110285A	PHBG 19 DS	75	45	60	W9 AN 262
110287	PHBG 19 DD	75	45	60	W9 AN 262
110229A	PHBG 19 RACING	75	45	60	W9 AN 262
110230	PHBG 19,5 AD	88	55	55	W6 AN 262
110235	PHBG 21 AD	100	55	55	W6 AN 262
110236	PHBG 21 BD	70	48	60	W16 AN 262
110280	PHBG 21 BS	72	50	60	W16 AN 262
110238	PHBG 21 CS	92	50	60	W7 AN 262
110237	PHBG 21 DS	92	50	60	W7 AN 262
110235A	PHBG 21 RACING	90	50	60	W7 AN 262

A GICLEUR ZIGLORE

PHBG / SHA Ø5

	N°
130050	50
130052	52
130055	55
130058	58
130060	60
130062	62
130065	65
130068	68
130070	70
130072	72
130075	75
130078	78
130080	80
130082	82
130085	85
130088	88
130090	90
130092	92
130095	95
130098	98
130100	100
130102	102
130105	105
130108	108
130110	110
130115	115
130116	118
130117	120
130118	122
130119	124
130120	128
130121	130
130122	132
130123	135
130124	138
130125	140
130126	142
130127	145
130128	150

B GICLEUR RALENTI IIGLORE MINIMO

PHBG	N°
130200	40
130201	45
130202	50
130203	55
130204	60

PIECES PEZZI

PHBG	
129596	CLIPS AIGUILLE PHBG
122838	ARRET ESSENCE POINTEAU PHBG
128376	BAGUE DIAM 26 A 24 PHBG
129475	BOISSEAU PHBG
129483	CLIPS DE BOISSEAU PHBG
129482	COUVERCLE BOISSEAU PHBG
129443	CUVE PHBG 17 19 21 NOIRE VERNIE
129444	CUVE PHBG 17 19 21
129444A	CUVE PHBG NOIRE VERNIE COMPL.
129511	DIFFUSEUR PHBG
129654	DIFFUSEUR PHBG 262AU
121692	ECROU DE TENDEUR PHBG
129450	FLOTTEUR PHBG
129501	GICLEUR DE STARTER PHBG
129497	JOINT DE CUVE PHBG
129514	JOINT DE COUVERCLE BOISSEAU
129599	KIT STARTER A LEVIER PHBG
122526	POCHETT JOINTS PHBG
121476	PROTEGE GAINÉ PHBG
129538A	RACCORD ARRIVEE AIR PHBG Ø60
129598	RACCORD ARRIVEE AIR PHBG
129597	RESSORT BOISSEAU PHBG
129336	RESSORT VIS D'AIR PHBG
124670	RESSORT VIS RALENTI PHBG
129538	STARTER A MAIN PHBG
121481	TENDEUR DE GAINÉ PHBG
121481A	TENDEUR DE GAINÉ DROIT PHBG
123698	TUBE COUDE PHBG
129517	VIS AIR PHBG
127673	VIS DE RALENTI PHBG
129442	VIS VIDANGE DE CUVE ALU PHBG

C AIGUILLES SPILLI

PHBG	N°
129590	AIGUILLE PHBG W2
129591	AIGUILLE PHBG W3
129592	AIGUILLE PHBG W4
129593	AIGUILLE PHBG W5
129594	AIGUILLE PHBG W6
129595	AIGUILLE PHBG W7
129600	AIGUILLE PHBG W8
129601	AIGUILLE PHBG W9
129595A	AIGUILLE PHBG W10
129605	AIGUILLE PHBG W16

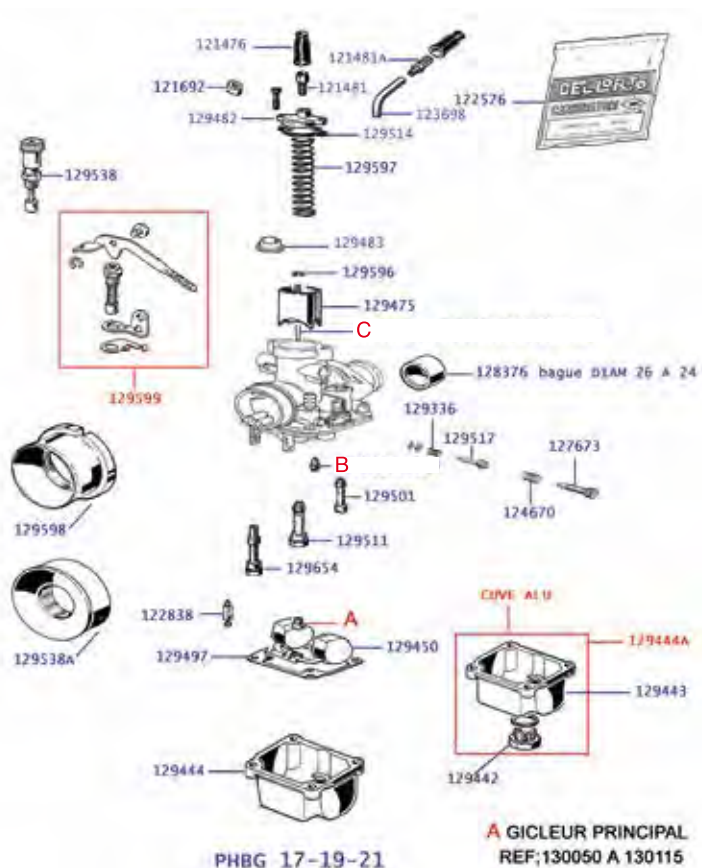

AIGUILLES SPILLI PHBG 19-21mm
S5816A X 10 AIGUILLES X 10 SPILLI
W3-W4-W5-W7-W8-W9
W10-W11W-12W-W25



CUVE TRANSPARENTE VASCHETTA TRANSPARENTE
129444B PHBG 17/19/21

* Adaptable
* Adattabile

Les références du constructeur sont seulement indicatives et n'impliquent pas que les pièces de rechange viennent du constructeur.
I codici di riferimento originali sono indicativi e non implicano che i ricambi provengano necessariamente dalla stessa fabbrica del costruttore.

MOTEUR MOTORE CARBURATEUR CARBURATORE

> DELL'ORTO PHVA



PHVA 16 QS
110214



PHVA 17,5 TS
110216A



PHVA 17,5 ED
110217



PHVA 17,5 TS
110218



PHVA 17,5 ED
110219

PHVA	PRINCIPAL PRINCIPALE	RALENTI MINIMO	STARTER STARTER	AIGUILLE SPILLO	DIFFUSEUR DIFFUSORE
110293 PHVA 12 PS	78	38	48	A12	GA211
110214 PHVA 16 QS					
110216A PHVA 17,5 TS	80	38	45	A20	GA211
110217 PHVA 17,5 ED	65	34	50	A07	FA211
110218 PHVA 17,5 TS	95	38	45	A02	GA209
110219 PHVA 17,5 ED	83	34	50	A07	FA212



PHVA 12 PS
110293

A GICLEUR ZIGLORE

PHVA / PHBN / PHBL / PHBH VHST / PHVB

	N°
130256	56
130271	60
130271A	62
130271B	65
130271C	68
130271D	70
130272	72
130275	75
130278	78
130280	80
130285	85
130290	90
130295	95
S427683	98
131100	100
131105	105
131110	110
131115	115
S427691	118
131120	120
S427693	122
131125	125
131130	130
131135	135
131140	140
S427696	145

PIECES PEZZI

PHVA

129806	AIGUILLE PHVA 16
129909	AIGUILLE PHVA BUXY
129910	AIGUILLE PHVA TYPHOON DERBI
129908	BOISSEAU PHVA TYPHOON DERBI
129905	CLIPS AIGUILLE PHVA
129914	CLIPS BOISSEAU PHVA
129899	COUVERCLE BOISSEAU DROIT PHVA
129900	COUVERCLE BOISSEAU COUDE PHVA
129915	CUVE PHVA 13678 96
129822	DIFFUSEUR PHVA TYPHOON
129823	DIFFUSEUR PHVA DERBI
129824	DIFFUSEUR PHVA BUXY
129906	FLOT.+ARRET ESSENCE POINTEAU PHVA
129835	GICLEUR DE STARTER D.45 PHVA
129836	GICLEUR DE STARTER D.50 PHVA
129912	JOINT COUVERCLE BOISSEAU PHVA
129917	JOINT DE CUVE PHVA
129918	KIT VIS RALENTI PHVA TYPHOON
129904	POCHETTE DE JOINTS PHVA
129907	POINTEAU PHVA
129913	RESSORT BOISSEAU PHVA
129902	RESSORT VIS AIR PHVA
124670	RESSORT VIS RALENTI PHVA
129919	STARTER A MAIN PHVA 17,5
129901	VIS AIR PHVA
129903	VIS RALENTI PHVA
129911	VIS COUVERCLE BOISSEAU PHVA
129916	VIS DE CUVE PHVA



**CUVE TRANSPARENTE
VASCHETTA TRANSPARENTE**
129915A PHVA PHBN

B GICLEUR RALENTI ZIGLORE MINIMO

PHVA / PHBN	N°
129832	32
129830	34
129831	38
129833	40
129833A	42

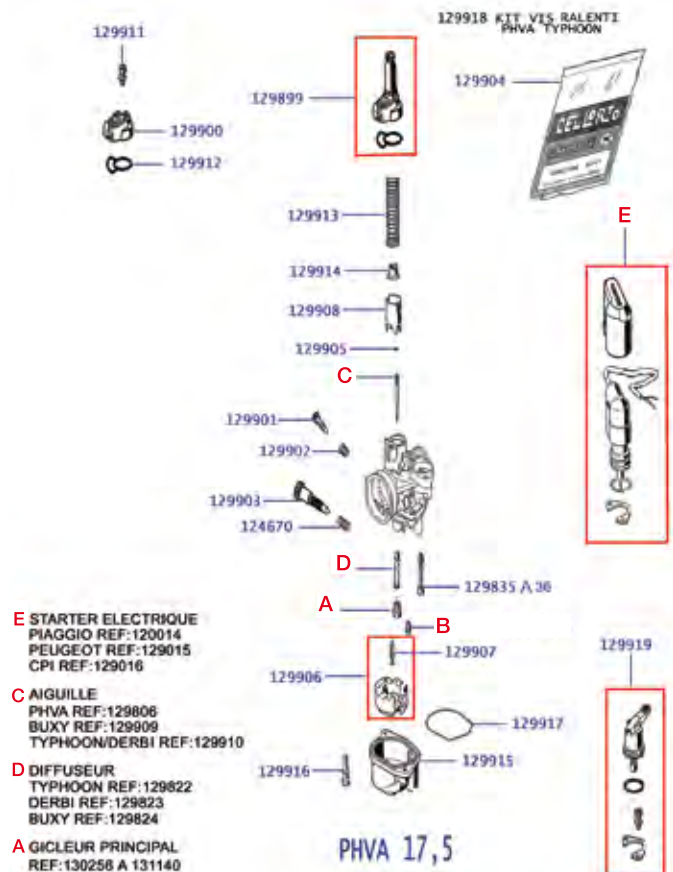

MOTEUR MOTORE CARBURATEUR CARBURATORE

> DELL ORTO PHVD



PHVD 22 BS
110252

> DELL ORTO PHVB



PHVB 19 DD
110228



PHVB 22 CD
110250



PHVB 22 CD
110251

> DELL ORTO PHBL



PHBL 25 BS
110290



PHBL 25 BD
110291

> DELL ORTO PHBH



PHBH 26 AS
110298



PHBH 26 BS
110299



PHBH 28 BS
110295

A GICLEUR ZIGLORE

PHVA / PHBN / PHBL / PHBH VHST / PHVB

	N°		N°
130130	32	130285	85
130130A	34	130290	90
130130B	36	130295	95
130130C	38	S427683	98
130130D	40	131100	100
130130E	42	131105	105
130130F	44	131110	110
130256	56	131115	115
130271	60	S427691	118
130271A	62	131120	120
130271B	65	S427693	122
130271C	68	131125	125
130271D	70	131130	130
130272	72	131135	135
130275	75	131140	140
130278	78	S427696	145
130280	80		

> DELL ORTO VHST SPECIAL 4T



VHST 26 BS
110301



VHST 28 BS
110296



VHST 28 BS
110297

PIECES ZIGLORE

PHBL / PHBH

129445 CUVE PHBL 25

PHBH

129445 CUVE PHBH 28

PHVB / PHVD / PHBH / PHBL	PRINCIPAL PRINCIPALE	RALENTI MINIMO	STARTER STARTER	AIGUILLE SPILLO	DIFFUSEUR DIFFUSORE
110228 PHVB 19 DD	85	45		M06	GH212
110250 PHVB 22 CD	95	45		M06	GH212
110251 PHVB 22 CD Starter Electr.	95	45		M06	GH212
110252 PHVD 22 BS					
110291 PHBL 25 BD	108	70	60	D22	AQ266
110290 PHBL 25 BS	102	70	60	D22	AQ266
110298 PHBH 26 AS	120	50	60	X06	T268
110295 PHBH 28 BS	105	55	70	X02	AV264
110296 VHST 28 BS	110	36	60	D48	HH271
110297 VHST 28 BS	142	35	60	D41	HE269

* Adaptable
* Adattabile

Les références du constructeur sont seulement indicatives et n'impliquent pas que les pièces de rechange viennent du constructeur.
I codici di riferimento originali sono indicativi e non implicano che i ricambi provengano necessariamente dalla stessa fabbrica del costruttore.

MOTEUR MOTORE CARBURATEUR CARBURATORE

TNT
Racing



TNT RACING

111010 Ø 17,5
111020 Ø 19
111030 Ø 21



MENBRANE CARBURATEUR

971130G *SCOOTERONE GY6 125CC 4T

TNT
Original



PZ 24 125CC

970141B CITY / DAX / PIT BIKE

TNT
Original



GY6 SCOOTER CHINOIS 50CC

971064F 2T STRIKE / GRIDO / OTTO / ROMA3 2T



GY6 SCOOTER CHINOIS 50CC

971158X 4T MONZA / ROMA 2&3 139QMB/A



GY6 SCOOTER CHINOIS 125CC

970662J 4T SCOOTERONE 152 QMI



***PEUGEOT / KYMCO**

111040 TYPE ORIGINE



CARBURATEUR GURTNER

110300 *103 TYPE ORIGINE



KIT CARBURATEUR COMPLET

961012MPOCKET Ø15

> **STARTER**



STARTER ELECTR. STARTER ELETTR
120014 *PIAGGIO
120015 *PEUGEOT
120016 *CPI (1)



STARTER AUTOM. STARTER AUTO
S110228 *BOOSTER 2004> PHVA/PHBN

> **STARTER**



STARTER A CABLE STARTER A CAVO
110400A L 0.5M
110400B L 1.5M

> **STARTER**



STARTER STARTER
129919C PHVA 17,5 A CABLE



STARTER STARTER
129919B *PWK CARBURATEUR



STARTER STARTER
129919A PHVA 17,5



STARTER A CABLE STARTER A CAVO
110400



STARTER AUTOM. STARTER AUTO
971064G *STRIKE/OTTO/ROMA/ GY6 2T



***CARBURATEUR MUKINI**
120017B (CPI / KEEWAY)



STARTER ELECTR. STARTER ELETTR
120017 *BOOSTER / NITRO / TKR



STARTER AUTOM. STARTER AUTO
971132I *SCOOTERONE GY6 125 4T (1)
971064G *STRIKE/OTTO/ROMA/ GY6 2T
971216E *ROMA 2/3 GY6 50 4T



***PIAGGIO 125 / VESPA LX / SPRINT
PRIMAVERA**
120017C OEM : AP5RAR000045



***PHVA PIAGGIO TYPE DELLORTO**
120017A OEM : 253872



**KIT REPARATION CABLE GAZ
KIT RIPARAZIONE CAVO GAS**
160070B

> **MENBRANE DE CARBURATEUR MEMBRANA CARBURATORE**



***HONDA SH 125/150**
OEM : 1611-KGF-911
110500



***YAMAHA MAJESTY 125 / 300**
OEM : 4HC143400100
110500A



***YAMAHA MAJESTY 125 / 150**
OEM : 5DS1434A1000
110500B



***KYMCO 125 / 250**
OEM :
110500C

MOTEUR MOTORE CARBURATEUR CARBURATORE

> GICLEURS ZIGLORE



TNT
Original

COFFRET 10 GICLEURS COFANETTO 10 ZIGLORE

*GURTNER/KEIHIN

S5818 Ø6 -50.52.55.58.60.62.65.68.70.72
S5819 Ø6 -75.78.80.82.85.88.90.92.95.98

COFFRET 10 GICLEURS COFANETTO 10 ZIGLORE

*SHA/PHBG

S5815 Ø5 -75.78.80.82.85.88.90.92.95.98
S5815A Ø6 -50.52.55.58.60.62.65.68.70.72

COFFRET 10 GICLEURS COFANETTO 10 ZIGLORE

*PHVA / PHGN / PHBL / PHBH / VHST / PHVB

S5816 Ø5 -100.102.105.108.110.112.115.118.120.122
S5813A Ø6 -50.52.55.58.60.62.65.68.70.72
S5813 Ø6 -75.78.80.82.85.88.90.92.95.98
S5814 Ø6 -100.102.105.108.110.112.115.118.120.122

> KIT REPARATION KIT RIPARAZIONE



**KIT REPARATION CARBU PHBG
KIT RIPARAZIONE CARBU PHBG**
S5809



**KIT REPARATION CARBU PWK
KIT RIPARAZIONE CARBU PWK**
S5809A



KIT REPARATION CARBURATEUR KIT RIPARAZIONE CARBURATORE

SCOOTER CHINOIS GY6 125CC
S5809C 152 QMI 12 PCS
FLOTTEUR/POINTEAU/AXE/JOINT
CUVE/JOINT COUVERCLE BOISSEAU



KIT REPARATION CARBURATEUR KIT RIPARAZIONE CARBURATORE

***PEUGEOT / GY6 50 2TPS**
S5809D 13 PCS
FLOTTEUR/POINTEAU/AXE/JOINT
CUVE/JOINT COUVERCLE BOISSEAU



KIT REPARATION CARBURATEUR KIT RIPARAZIONE CARBURATORE

SCOOTER CHINOIS GY6 50CC 4TPS
S5809B 139 QMB/A 14 PCS
FLOTTEUR/POINTEAU/AXE/JOINT
CUVE/JOINT COUVERCLE BOISSEAU



**KIT VIS DE RICHESSE
KIT VITI CARBURAZIONE**
129445C PHBH-PHBL-PHF-PHM-VHST



**KIT VIS DE RALENTI
KIT VITI MINIMO CARBURATORI**
129445B PHBH-PHBL-PHF-PHM-VHBT



**PIPETTE PLASTIQUE ARRIVEE ESSENCE
PIPETTA / RACCORDO ENTRATA BENZINA**
129445A PHBH-PHBL-PHF-PHM-VHBT

DELLORTO
CARBURATORI

MOTEUR MOTORE

POMPE ET ROBINET ESSENCE POMPA & RUBINETTO BENZINA

> POMPE ESSENCE POMPA BENZINA



N
NEW

***BMW K100LT K100RS K100RT
K1100LT K75 K75C K75rt k75s**
420351E OEM : 640516



N
NEW

***SUZUKI AN400 BURGMAN 2003-
06 / BMW F650 / 800CC RT1200 /
R1200GS**
420351F



N
NEW

***PIAGGIO / VESPA GTS**
420351E OEM : 640516



***BEVERLY 400/500**
420351C



***SUZUKI BURGMAN 250/400**
420351B



***TMAX 500 / XMAX 123 / MP3**
420351A



***HONDA SH 125/150/300**
420351D

> INJECTEUR INIEZIONE



N
NEW

INJECTEUR INIEZIONE

111060	*DUCATI / MOTO GUZZI TYPE IWP189	
111060A	*PIAGGIO BEVERLY / X9 500CC TYPE IWP048	OEM : 8304275
111060B	*VESPA GTS TYPE IWP182	OEM : 6388498
111070	*TMAX 500 / 530CC	OEM : 2C0-13761-10
111070A	*YAMAHA XMAX 125CC	OEM : 5D7-E3770-00
111071	*HONDA SH 125	
111071A	*HONDA SH 300	

> ROBINET ESSENCE RUBINETTO BENZINA



***PIAGGIO X9 125/200cc 01/03**
420350 POMPE ESSENCE POMPA BENZINA



***SKYLINER 125 98/00**
420312 A DEPRESSION A DEPRESSIONE



***UNIVERSEL *GY6**
420351 A DEPRESSION A DEPRESSIONE



***SOLEX**
S56932 POMPE ESSENCE POMPA BENZINA
S56434 SIEGE MEMBRANE (1)
S56215 MEMBRANE (2)



***SCOOTER CHINOIS M16 X 150** 1
420308 A DEPRESSION A DEPRESSIONE
***SCOOTER CPI M14 X 150**
420309 A DEPRESSION A DEPRESSIONE



***PEUGEOT / BUXY / ZENITH**
420313 A DEPRESSION A DEPRESSIONE



***PIAGGIO / APRILIA / TREKKER
*DERBI SENDA**
420311A



***PIAGGIO / APRILIA / TREKKER
*DERBI SENDA**
420311 A DEPRESSION A DEPRESSIONE

MOTEUR MOTORE ROBINET ESSENCE RUBINETTO BENZINA

TNT
Original



***LUDIX 10 ONE / TRENT / SNAKE**
420352



***FLY / LIBERTY / VESPA LX/LXV**
420353



***PIAGGIO / MINARELLI**
420353B < 2008



***NRG MC2/MC3 OVETTO / STUNT**
420353A



***LUDIX 10 SP BLASTER**
420352A



***CPI SM/SX 50 >2007**
420358



***BOOSTER**
420310 A DEPRESSION A DEPRESSIONE



***PIAGGIO ZIP**
420357 < 2008



***SCOOTER CPI M14 X 150**
420309A A DEPRESSION A DEPRESSIONE



***HONDA SH / DYLAN / CBR 125/150**
420354



***BETA 50RR**
420359B



***HM 50CC**
420359A



***HM 50CC**
420359 DERAPAGE



***CIAO**
420355



***MBK 51**
420220



***PEUGEOT 103**
420305



***PEUGEOT FOX**
420306



***MBK**
420356



***CITY 50 / 125**
420225



UNIVERSAL 2 SORTIES *GY6
420312B A DEPRESSION A DEPRESSIONE



TYPE MIKUNI UNIVERSEL
420350A POMPE ESSENCE POMPA BENZINA



***UNIVERSEL 1 SORTIE**
420312D 6MM AVEC FIXATION



***UNIVERSEL 1 SORTIE**
420312C A DEPRESSION A DEPRESSIONE



UNIVERSAL METAL
420314



UNIVERSAL PLASTIQUE
420315 06
420315A 08

* Adaptable
* Adattabile

Les références du constructeur sont seulement indicatives et n'impliquent pas que les pièces de rechange viennent du constructeur.
I codici di riferimento originali sono indicativi e non implicano che i ricambi provengano necessariamente dalla stessa fabbrica del costruttore.

AS 87

MOTEUR MOTORE

ROBINET ESSENCE RUBINETTO BENZINA

> BOUCHON TAPPO BEZINA



***MOB**
422110

*NITRO	
422153	STYLE CARBONE CARBONIO
422154	CHROME CROMO



> FILTRE ESSENCE FILTRO BENZINA

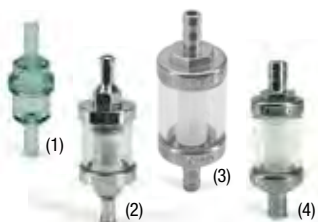

FILTRE ESSENCE FILTRO BENZINA

425000	*ECO Ø 6	(1)
425010	*CHROM Ø 6,5	(2)
425015	*CHROM Ø 6	(3)
425016	*CHROM Ø 8	(4)



FILTRE ESSENCE CNC Ø6 FILTRO BENZINA CNC Ø6

425020	ARGENT ARGENTO
425020A	BLEU BLU
425020B	ROUGE ROSSO
425020C	NOIR MAT BLACK MATT



**FILTRE ESSENCE Ø6
FILTRO BENZINA Ø6**
425017 PLASTIQUE DEMONTABLE



**FILTRE ESSENCE
FILTRO BENZINA**
S16132 SOLEX



**FILTRE ESSENCE RESERVOIR
FILTRO BENZINA SERBATOIO**
S16092 SOLEX

> DURITE ESSENCE TUBO BENZINA



DURITE COULEUR FLOUORESCENCE

TUBO FLUO	
S5821	Ø5 - BLANC BIANCO
S5822	Ø5 - VERT VERDE
S5823	Ø5 - JAUNE GIALLO
S5824	Ø5 - ROSE ROSA
S5825	Ø5 - ORANGE ARANCIO



DURITE NOIRE TUBO NERO

424010A	Ø5 X 10 - 10 ML
423999	Ø3 X 5 - 10 ML
S72991	Ø4 X 10 ML
S992	Ø5 X 10 ML



DURITE TRANSPARENTE TUBO TRASPARENTE

424000	4 X 7,5 - 10 ML
424010	5 X 8 - 10 ML
S72103	5 - 10 ML
S72104	6 - 10 ML



DURITE HUILE CAOUTCHOUC TUBI OLIO

423999A	2 X 4 - 10 ML GRAISSAGE SEPARÉ
---------	--------------------------------



CLIPS DURITE ESSENCE FISSAGGIO TUBO BENZINA

423800B	Ø 5 MM	N
423800C	Ø 6 MM	N
423800A	Ø 8,5 MM	



COUPLEUR DE DURITE ESSENCE CONETTORE TUBO BENZINA

423800	
--------	--



KIT DURITE KIT TUBO

424050	*BOOSTER / STUNT
--------	------------------

MOTEUR MOTORE ADMISSION ASPIRAZIONE

> MVT RACING

MVT



***MINARELLI Horiz.**
***SR / NITRO / OVETTO / CPI**
110440 VITON CARBON



***MINARELLI Horiz.**
***NITRO / AEROX Ø28MM**
110440A



***LUDIX Ø19**
35626 VITON CARBON



***MINARELLI Vert.**
***BOOSTER / BWS Ø28MM**
25627C



***MINARELLI Vert.**
***BOOSTER / BW'S Ø19MM**
35627

> SCOOTER

TNT
Original



***PIAGGIO TYPHOON / NRG**
140614



***MINARELLI Vert.**
***BOOSTER / STUNT**
140610



***MINARELLI Horiz.**
***NITRO / AEROX / CPI**
140615



***PEUGEOT LUDIX**
140618



***PEUGEOT TREKKER 100**
140620



***PEUGEOT TREKKER**
140600



***UNIVERSAL**
140605



***APRILIA SCARABEO 50CC**
***VESPA ET4 50CC**
OEM: 480799 - 478193
140614E SOUPLE FLESSIBILE



KYMCO AGILITY 50 4T
OEM: 00102054
140611 SOUPLE FLESSIBILE

>

TNT
Original



***MINARELLI Vert.**
***BOOSTER / STUNT**
144899 CARBONE CARBONIO
144899A



***PIAGGIO TYPHOON / NRG**
144901



***MINARELLI Horiz.**
***SR / NITRO / OVETTO / CPI**
144905 DOUBLE LAMELLES
144905A SIMPLE LAMELLE (1)



***PEUGEOT LUDIX**
144906



***PEUGEOT TREKKER**
144902

* Adaptable
* Adattabile

Les références du constructeur sont seulement indicatives et n'impliquent pas que les pièces de rechange viennent du constructeur.
I codici di riferimento originali sono indicativi e non implicano che i ricambi provengano necessariamente dalla stessa fabbrica del costruttore.

MOTEUR MOTORE ADMISSION ASPIRAZIONE

> SCOOTER

parmakit



***MINARELLI Vert.**
***BOOSTER / STUNT**

140610B Ø17,5 / 19 / 21



***MINARELLI Vert.**
***BOOSTER / STUNT**

140610A Ø25 / 28 / 30



***MINARELLI Horiz.**
***NITRO / AEROX / OVETTO**

140615A Ø17,5 / 19 / 21



***MINARELLI Horiz.**
***NITRO / AEROX / OVETTO**

140615B Ø28 / 30

> 50 A BOITE 50CC A MARCE

TNT
Original



144907 ***DERBI**
144908 ***AM6**



***MINARELLI AM6**
140616



***HONDA 80CR**
140617



***DERBI SENDA**
140619



***MINARELLI AM6**
140616A Ø19 / 24



***PIT BIKE 107/140**
140619B Ø34



***DERBI SENDA**
140619A Ø19 / 24

> MAXI SCOOTER

TNT
Original



***PIAGGIO LIBERTY / SKIPPER / ZIP**
125-150CC
OEM: 485587 - 827792
140614F SOUPLE FLESSIBILE



***PIAGGIO X9 125-200CC**
OEM: 484748 - 840689
140614C SOUPLE FLESSIBILE



***PIAGGIO X8 125-200 / GILERA**
RUNNER / VESPA GT 125
OEM: 840949 - AP8575043 - B016579
140614D SOUPLE FLESSIBILE



***YAMAHA TMAX 2007-2015**
OEM: 5VU-13596-01
140630 DROIT



***YAMAHA TMAX 2007-2015**
OEM: 5VU-13586-01
140630A GAUCHE SINISTRA



***YAMAHA TMAX 2003-2007**
OEM: 5GJ-13596-010
140630B DROIT DESTRA



***YAMAHA TMAX 2003-2007**
OEM: 5GJ-13586-020
140630C GAUCHE SINISTRA



***YAMAHA MAJESTY 125-180 03-2008**
OEM: 5XM-E3585-00
140630D



***YAMAHA MAJESTY 125-180 98-2002**
OEM: 5DS-1358-500-00 - 76005500
140630E



***KYMCO AGILITY 125-150/ R16**
OEM: 00122198-00117091-0012116
140611A SOUPLE FLESSIBILE

MOTEUR MOTORE ADMISSION ASPIRAZIONE

> MVT RACING



***AM6**
110450 VITON CARBON



***AM6 026-28**
35627A



***DERBI**
110450A VITON CARBON



***DERBI 026-28**
35627B

> CYCLO CICLOMOTORE



***103**
145105 ALU ALLUMINIO



***103 SPX 015**
140520



***AV-7 / MBL 88/89**
140300



***MBK 51**
145092

> FILTRE A AIR FILTRO ARIA



OBUS 028/35
30° 90°

115210	NOIR NERO
115210A 115211A	CHROME CROMO
115210B	BLEU BLU
115210C	ROUGE ROSSO
115210D 115211D	STYLE CARBONE CARBONIO
115210F 115211F	BLANC BIANCO



R-EVO II 028/35
45° 90°

115200 115206	NOIR NERO
115201 115207	CHROME CROMO



FILTRE A AIR 028/35
116008 STYLE CARBONE CARBONIO



MOUSSE 028/35 SPUGNA 028/35
115020 DROIT DESTRA



R-BOX HS 028/35
0° 90°

115080 115094	NOIR NERO
115081 115095	JAUNE GIALLO
115082 115096	ROUGE ROSSO
115083 115097	BLEU BLU



TRANSFORMER 028/35
0° / 90°

115212	CHROM / NOIR NERO
115212A	NOIR NERO / BLEU BLU
115212C	NOIR NERO / STYLE CARBONE CARBONIO
115212D	NOIR NERO / BLANC BIANCO

MOTEUR MOTORE FILTRE A AIR FILTRO ARIA

TNT
Tuning



TNT MOUSSE «SMALL» Ø28/35

30°

115023	NOIR	NERO
115023B	ROUGE	ROSSO
115021A	BLANC	BIANCO



TNT MOUSSE «SMALL» Ø28/35

0°

115023D	NOIR	NERO
115023F	ROUGE	ROSSO



TNT MOUSSE «BIG» Ø28/55

0°

115022	NOIR	NERO
115022B	ROUGE	ROSSO



TNT MOUSSE «STAR» Ø28/55 90°

115024	ROUGE	ROSSO
115024A	NOIR	NERO



TNT MOUSSE «CROSS» Ø28/55 90°

115024B	ROUGE	ROSSO
115024C	NOIR	NERO



R-EVOLUTION Ø28/35

30° 90°

115085	115120	NOIR	NERO / ROUGE	ROSSO
115085A	115127	CARBON	STYLE / ROUGE	ROSSO
115086	115121	NOIR	NERO / BLEU	BLU
115087		NOIR	NERO / JAUNE	GIALLO
115088	115123	CHROME	CROMO / NOIR	NERO
115089	115124	CHROME	CROMO / ROUGE	ROSSO
115090	115125	CHROME	CROMO / BLEU	BLU



«KN» Ø28/35

0° 90°

115060	115065	BLEU	BLU	
115060A	115065A	BLANC	BIANCO	
115062	115067	ROUGE	ROSSO	
115063	115069	CHROME	CROMO	
115004	115068	STYLE	CARBONE	CARBONIO



«KN» SMALL Ø28/35

0° 90°

115002	115003	BLEU	BLU	
115006	115001	STYLE	CARBONE	CARBONIO
115005	115000	CHROME	CROMO	
115002A	115003A	BLANC	BIANCO	



TYPE KN Ø28/35 45° CARENZI

115050	TAILLE	M
115050A	TAILLE	L



TYPE KN Ø28/35 45° R-EV02

115050B

CARENZI

NOEND



TYPE KN NOEND CLASSIC

115064	Ø	45	MM
115064A	Ø	50	MM
115064B	Ø	55	MM
115064C	Ø	60	MM

N
NEW

MOTEUR MOTORE

FILTRE A AIR FILTRO ARIA

TNT
Tuning



BOITE A AIR UNIVERSELLE
SCATOLA FILTRO ARIA UNIVERSALE
115041 Ø45/35



ADAPTATEUR BOITE A AIR
ADATTATORE
114005 *CPI SM/SX

CARENZI



GAZ BOX SCOOTER
116020

N
NEU

TNT
Original



***MBK BOOSTER / STUNT**
FILTRE COMPLET FILTRO COMPLETO

114043 BLANC BIANCO
114044 NOIR NERO
114047 TRANSPARENT TRASPARENT
114048 STYLE CARBONE CARBONIO
114049 CHROME CROMO



***MBK BOOSTER / STUNT**
CAPOT DE FILTRE COPERCHIO FILTRO

114054 BLANC BIANCO
114055 STYLE CARBONE CARBONIO
114050 CHROME CROMO



***MBK BOOSTER 2004**
FILTRE COMPLET FILTRO COMPLETO

114052 NOIR NERO



***NITRO/OVETTO/APRILIA**
FILTRE COMPLET FILTRO COMPLETO

114042 NOIR NERO
114042A TRANSPARENT TRASPARENT



***PIAGGIO TYPHOON / ZIP 2000**
FILTRE COMPLET FILTRO COMPLETO

114066 NOIR NERO



***LUDIX**
FILTRE COMPLET FILTRO COMPLETO

114018 NOIR NERO
114018A CHROME CROMO



***SPEEDFIGHT 1-2 / TREKKER / VIVACITY**
FILTRE COMPLET FILTRO COMPLETO

114065 TRANSPARENT TRASPARENT
114065A NOIR NERO



***GY6 50CC 4TPS 10P / KYMCO AGILITY 10P**
114041



***GY6 50CC 4TPS 12P / KYMCO AGILITY 12P**
114041A

* Adaptable
* Adattabile

Les références du constructeur sont seulement indicatives et n'impliquent pas que les pièces de rechange viennent du constructeur.
I codici di riferimento originali sono indicativi e non implicano che i ricambi provengano necessariamente dalla stessa fabbrica del costruttore.

MOTEUR MOTORE FILTRE A AIR FILTRO ARIA

> *YAMAHA

TNT
Original



***OVETTO NEOS 50 4T**
114021H



***SKYLINER / FLAME X 125**
114020A



***YAMAHA CYGNUS 125**
114021J



*** YAMAHA CYGNUS 95 -2003 MBK FLAME**
114021L OEM: 4CWE44510200



***YAMAHA MAJESTY 400 04 / 06**
114020F



***YAMAHA MAJESTY 400 04 / 06**
114020D GAUCHE LEFT



***YAMAHA MAJESTY 400 04 / 06**
114020E DROITE RIGHT



***YAMAHA X-MAX / X-CITY 125-250**
114020H



*** YAMAHA XMAX 250 2009 / VERSITY 300 2003-2006**
114021M OEM: 5GM-15407-0000



***YAMAHA XMAX 300CC**
114022 OEM : B74-WE445-00



***YAMAHA XMAX 300CC**
114022A OEM : B74-E5407-00



***YAMAHA T-MAX 500**
114020



***YAMAHA T-MAX 01 / 07**
114020M



***YAMAHA T-MAX 01 / 07**
114020N DROITE RIGHT



***YAMAHA T-MAX 08 / 10**
114020L



***YAMAHA T-MAX 500 08 / 09**
114020I



***YAMAHA T-MAX 2012**
114020O



*** YAMAHA XENTER 125-150**
114021U OEM: 525E4451000



*** YAMAHA T-MAX 530 2017**
114021Z OEM: BC3-14451-00

MOTEUR MOTORE FILTRE A AIR FILTRO ARIA

> *HONDA

TNT
Original



*HONDA LEAD 110
114021T



*HONDA MSX 125CC / URBAN 125CC
114021O OEM:17210-K26-902



*HONDA HS 125/150/ 2013-2014
114021E



*HONDA PCX 125/150 2012
114021F



*HONDA PCX
114020K



*HONDA SH 125/150cc ABS 2017
114021Y OEM: 17210-K77-V00

N
NEW



*HONDA SH 125/150cc
114020B



*HONDA SH 300
114020G



*HONDA SILVERWING 400/600
114021K OEM: 17230-MCT-00



*HONDA INTEGRA 700 /750
114021S OEM:17210-MGS-D30



*PANTHEON 03-07 / SILVERWING 07-10
114020J

> *SUZUKI

TNT
Original



*BURGMAN 125/200 07/10
114020S



*SUZUKI SIXTEEN UX125 /150 08-12
114021P OEM: 13780-20H00-000



*SUZUKI BURGAM 400
114021



*SUZUKI BURGAM 650
114021C

* Adaptable
* Adattabile

Les références du constructeur sont seulement indicatives et n'impliquent pas que les pièces de rechange viennent du constructeur.
I codici di riferimento originali sono indicativi e non implicano che i ricambi provengano necessariamente dalla stessa fabbrica del costruttore.

MOTEUR MOTORE

FILTRE A AIR FILTRO ARIA

> *SYM

TNT
Original



***SYM 125 /150 HD / PEUGEOT LXR**
114021R OEM: 17211-HHA-000



***SYM SIMPLY 50 7-11 / FIGGLE 2/ JET 4**
114021G



***SYM DOWNTOWN 125/250**
114020Z



***SYM JOYMAX 250**
114020W



***SYM CITYCOM 300**
114021D



***SYM PEOPLE 300 GTI**
114021A



***SYM JOYRIDE 125/200 EU2**
114021B



***SYM DOWNTOWN 300i ABS**
114020X

> *KYMCO

TNT
Original



***KYMCO AGILITY 50CC 4T**
114020R 12"



***KYMCO AGILITY 50CC 4T**
114020Q 10"



***KYMCO PEOPLE 250 2003-2006**
114020V



***KYMCO AGILITY / PEOPLE 125/250/200 16"**
114020T



***KYMCO AGILITY 2010**
114020Y



***KYMCO K-XCT 125/300**
114021N OEM: 17211-LKG7-E000 / 00117245 /
17211-LEA7-E000

> *PIAGGIO

TNT
Original



***PIAGGIO FLY 125**
114021I



***PIAGGIO VESPA 125/150 LX 3V / S 3V 2012**
114021Q OEM: B016409



***PIAGGIO X9 500 EVOLUTION DE 2003-07**
114020C OEM: 06615400-487845

MOTEUR MOTORE

MOUSSE POUR FILTRE AIR SPUGNA FILTRO ARIA

> SCOOTER



MOUSSE DOUBLE DENSITE
SPUGNA DOPPIA SENSITA
***BOOSTER / BWS**
114011



MOUSSE DOUBLE DENSITE
SPUGNA DOPPIA SENSITA
***NITRO / OVETTO**
114011A



MOUSSE DOUBLE DENSITE
SPUGNA DOPPIA SENSITA
***TYPHOON-X / STALKER / RUNNER / LIBERTY 2T**
114011B

CARENZI

by **MANGUCCI FILTERS**

> SCOOTER



***BOOSTER / STUNT**
114010



***NITRO / OVETTO**
114010A



***TYPHOON**
114010B



***TYPHOON CATALISE**
114010F

TNT
Original

by **MANGUCCI FILTERS**



***NRG/MC**
114010D



***SPEEDFIGHT / TREKKER / VIVACITY**
114010C



***VIVACITY 3 / SPEEDFIGHT 3**
114010K



***PEUGEOT LUDIX 50CC**
114010Q



***SYM JET EURO-X**
1140100



***PEUGEOT V-CLIC 50CC 4T**
114010P



***PIAGGIO ZIP 50CC**
114010R



***TNT MOTOR STRADA/ROMA 2 & 3**
971163I GY6 50CC

> MAXI SCOOTER



***SKYLINER 125**
114010G



***X-MAX / X-CITY 125**
114010J



***PIAGGIO X8 125/200/250 > 04**
114010I



***PIAGGIO X9 125 EVOL 03**
114010H



***PIAGGIO X9 125 / RUNNER**
114010E

TNT
Original

by **MANGUCCI FILTERS**

> 50CC A BOITE 50CC A MARCE



*** DERBI SENDA**
114010L



*** RIEJU SPIKE/RR**
114010M



*** XPOWER / TZR50**
114010N



***SOLEX**
S56758

TNT
Original

* Adaptable
* Adattabile

Les références du constructeur sont seulement indicatives et n'impliquent pas que les pièces de rechange viennent du constructeur.
I codici di riferimento originali sono indicativi e non implicano che i ricambi provengano necessariamente dalla stessa fabbrica del costruttore.



MARCHALD FILTERS



MOTEUR MOTORE

FILTRE A AIR FILTRO ARIA

MARCHALD FILTERS



POWER FILTER	NOIR	ROUGE
	NERO	ROSSO
L 65 MM 28-43 MM	114219A	114220A
L 65 MM 46-62 MM	114222A	114221A



POWER FILTER	NOIR	ROUGE
	NERO	ROSSO
L 95 MM 28-43 MM	114219B	114220B
L 95 MM 46-62 MM	114222B	114221B



POWER FILTER	NOIR	ROUGE
	NERO	ROSSO
L 105 MM 28-43 MM	114219C	114220C
L 105 MM 46-62 MM	114222C	114221C



AIR PLUS KHR	NOIR	ROUGE
	NERO	ROSSO
L 170 MM 28-43 MM	114216	114217
L 170 MM 46-62 MM	114216A	114217A



POWER FILTER	NOIR	ROUGE
	NERO	ROSSO
L 170 MM 28-43 MM	114219D	114220D
L 170 MM 46-62 MM	114222D	114221D



SMALL FILTER ROUGE ROSSO
114225A L 75 MM - 30° - Ø28 MM



AIRBOX
114218A 28-36 MM L 90 MM 5 ENTRÉES 1
114218B 28-36 MM L 130 MM 9 ENTRÉES 2



SMALL FILTER	NOIR	ROUGE
	NERO	ROSSO
L 75 MM Ø28 MM	114214A	114215A
L 75 MM Ø32 MM	114214B	114215B
L 75 MM Ø36 MM	114214C	114215C



SMALL FILTER	NOIR	ROUGE
	NERO	ROSSO
L 95 MM - 30° - Ø28 MM	114223A	114224A
L 95 MM - 30° - Ø32 MM	114223B	114224B
L 95 MM - 30° - Ø36 MM	114223C	114224C



*TMAX 500 - 2001-07
114226



*TMAX 500/503 - 2008
114226A



*PIAGGIO BEVERLY 250
114226B



MOUSSE DOUBLE DENSITÉ SPUGNA DOPPIA SENSITÀ
114225B 330 X 330 X 9
114225 330 X 330 X 17

* Adaptable
* Adattabile

Les références du constructeur sont seulement indicatives et n'impliquent pas que les pièces de rechange viennent du constructeur.
I codici di riferimento originali sono indicativi e non implicano che i ricambi provengano necessariamente dalla stessa fabbrica del costruttore.

MOTEUR MOTORE

MOTEUR GY6 MOTORE GY6

> POT D'ÉCHAPPEMENT SCOOTER MARMITTA SCOOTER



POT ÉCHAPPEMENT TNT ORIGINAL 4T 50CC
971163L MOTEUR 139QMB/A



JOINT ÉCHAPPEMENT 50CC 4T
970918N *ROMA



POT ÉCHAPPEMENT TECNIGAS SCOOTER 125CC
017230 MOTEUR 152QMI

> CYLINDRE FONTE CILINDRO GHISA



***AGILITY**

		CYLINDRE COMPLET CILINDRO COMPLETO	
030317A		125CC Ø52,4 152 QMI	(1)
030317C		150CC Ø57 157 QMJ	



***KYMCO/AGILITY50/SCOOTER CHINOIS 4T GY6**

030317		CYLINDRE COMPLET CILINDRO COMPLETO	
050343		Ø40 139 QMA/B	



**CULASSE
TESTA**

038700E COMPLETE *125 4T 152 QMI



**CULASSE
TESTA**

038700D COMPLETE 139 QMA/B

> VILEBREQUINS ALBERO MOTORE



SCOOTER 50 SCOOTER 50

090850 *KYMCO/AGILITY 50/SCOOTER GY6 50CC 4T

SCOOTER 125 SCOOTER 125

090850A *SCOOTERONE / GY6 125 4T (1)



**BOUCHON DE VIDANGE
TAPPO DI SCARICO**

*HONDA / KYMCO / PIAGGIO 4T
*GY6 50 & 125
623000K

MOTEUR MOTORE

MOTEUR GY6 MOTORE GY6

> CARTER VARIATEUR CARTER VARIATORE



***SCOOTER CHINOIS 50 4T**
289040 R10"



***SCOOTER CHINOIS 50 4T**
289040A R12"

> JOINTS HAUT MOTEUR GUARNIZIONI COMPLETO



***MOTEUR GY6 50 2T**
072032B



***KYMCO AGILITY / GY6 4T 50CC**
071812



***MOTEUR GY6 50**
072032



***MOTEUR GY6 125 4T**
072032A

> VARIATEUR & EMBRAYAGE VARIATORE & FRIZIONE



VARIO TNT RACING

286881 *STRADA / ROMA / AGILITY
286885 *SCOOTERONE 125 / AGILITY 125 (1)



VARIO TNT ORIGINAL

970670F *SCOOTER CHINOIS MOTEUR GY6 4T
971157Q *SCOOTER CHINOIS MOTEUR GY6 (1)
971069 *STRIKE / GRIDO / OTTO / ROMA 2T
286881A *SYM / PEUGEOT / HALO / BOSTON 4TPS 12P



EMBAYAGE COMPLET FRIZIONE COMPLETO

971157U *STRADA / MONZA / ROMA 2/3
971122H SCOOTER 125CC 4T (1)
287644 *SYM / PEUGEOT / HALO / BOSTON 12P 50 4TPS

* Adaptable
* Adattabile

Les références du constructeur sont seulement indicatives et n'impliquent pas que les pièces de rechange viennent du constructeur.
I codici di riferimento originali sono indicativi e non implicano che i ricambi provengano necessariamente dalla stessa fabbrica del costruttore.

MOTEUR MOTORE

MOTEUR GY6 MOTORE GY6

> DEMARREUR STARTER

TNT
Original



***SCOOTER CHINOIS GY6**

090414 AXE DE KICK COMPLET (1)
090414A NOIX DE KICK (2)



**PIGNON INTERNE DEMARREUR
PIGNONE INTERNO ACCENSIONE**

187196C *KYMCO 50 4T / GY6 50 4T

> CARBURATEUR CARBURATORE

TNT
Original



GY6 SCOOTER CHINOIS 50CC

971064F 2T STRIKE / GRIDO / OTTO / ROMA3 2T



GY6 SCOOTER CHINOIS 50CC

971158X 4T MONZA / ROMA 2&3 139QMB/A



GY6 SCOOTER CHINOIS 125CC

970662J 4T SCOOTERONE 152 QMI

> PIECES CARBURATEUR PARTI PER CARBURATORE

TNT
Original



(1)

STARTER AUTOM. CHOKE AUTOM.

971132I *SCOOTERONE GY6 125 4T (1)
971064G *STRIKE/OTTO/ROMA/ GY6 2T
971216E *ROMA 2/3 GY6 50 4T



MENBRANE CARBURATEUR

971130G *SCOOTERONE GY6 125CC 4T

> FILTRE A AIR ET MOUSSE FILTRO ARIA E SPUGNA

TNT
Original



***SCOOTER CHINOIS GY6 50CC 4TPS 10P /
KYMCO AGILITY 10P / ROMA 4TPS 10P**

114041



***TNT MOTOR STRADA/ROMA 2 & 3**

971163I MOUSSE SPUGNA



**SCOOTER CHINOIS GY6 50CC 4TPS 12P / KYMCO
AGILITY 12P**

114041A

MOTEUR MOTORE

MOTEUR GY6 MOTORE GY6

> FREINAGE FRENI

TNT
Original



MACHOIRE FREIN AR COMPLET
FRENI POSTERIORE COMPLETO
971160T *ROMA 2/3

> ELECTRICITE ELETTRICITÀ

TNT
Original



ALLUMAGE
ACCESSIONE
***SCOOTER CHINOIS**

971064X 50CC 2T GY6 1PE40QMB STRIKE GRIDO ROMA 2TEMPS OTTO
971157J 50CC 4T GY6 ROMA 2/3 4 TPS
970664P *SCOOTERONE 125 GY6 4T (1)



BOBINE / CDI
BOBINA / CDI
***ROMA 2/3 4T**
970919K *SCOOTER CHINOIS GY6



BOBINE / CDI
BOBINA / CDI
***GHOST OTTO GRIDO ROMA 2T**
971060R *SCOOTER CHINOIS GY6 50CC 2TPS



DEMARREUR
MOTORINO AVVIAMENTO
***SCOOTER CHINOIS GY6 125CC 4T**
970664D



BOBINE / CDI
BOBINA / CDI
***SCOOT CHINOIS 4T 50CC & 125CC**
180022A



CONTACTEUR A CLE
KIT SERRATURE
***SCOOTER CHINOIS GY6 50CC 2T**
971113K GY6 50cc TYPE C



CONTACTEUR A CLE
KIT SERRATURE
***MONZA 50 4T 2T**
208229A GY6 50cc TYPE B



CONTACTEUR A CLE
KIT SERRATURE
***ROMA 2/3 ET ROMA 2 T**
970919L GY6 50cc TYPE A

> ECLAIRAGE LUCE

TNT
Original



FEUX ARRIERE
FARO POSTERIORE
971165E COMPLET VCLIC *STRADA / ROMA 2/3

* Adaptable
* Adattabile

Les références du constructeur sont seulement indicatives et n'impliquent pas que les pièces de rechange viennent du constructeur.
I codici di riferimento originali sono indicativi e non implicano che i ricambi provengano necessariamente dalla stessa fabbrica del costruttore.

MOTEUR MOTORE POCKET BIKE

TNT
Original



MOTEUR COMPLET MOTORE COMPLETO BIG BORE
961012P *POCKET PISTA Ø44 MM AXE Ø12



CYLINDRE CILINDRO
961010K *POCKET PISTA Ø40

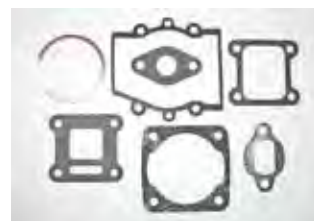

JOINTS GUARNIZIONI
960128V TOUT POCKET AIR



LANCEUR MESSA IN MOTO
9610100 TOUS MODELES ALL MODELS



EMBAYAGE RACING FRIZIONE
9601012Q *POCKET PISTA



EMBAYAGE COMPLET FRIZIONE
9610111 *POCKET PISTA / SM50
* MINQUADER / DIRT 50



CARBURATEUR CARBURATORE
961010S *POCKET PISTA MD01 MD03 QD01



KIT CARBURATEUR KIT CARBURATORE
961012M *POCKET PISTA Ø40



BOBINE D'ALLUMAGE BOBINA
961011V *POCKET PISTA / SM50
* MINQUADER / DIRT 50



BOUGIE CANDELA
186221 BOUGIE NGK BPMR6A
SE MONTE SUR POCKET BIKE 2T



CHAINE CATENA
961010J *POCKET PISTA

MOTEUR MOTORE

*YAMAHA PW 50/80



CYLINDRE FONTE	
CILINDRO GHISIA	
*YAMAHA PW 50 2T	
030322	CYLINDRE COMPLET CILINDRO COMPLETO
050363	Ø40
071808B	Ø40



CYLINDRE FONTE	
CILINDRO GHISIA	
*YAMAHA PW 80 2TPS	
030322A	CYLINDRE COMPLET CILINDRO COMPLETO



CARBURATEUR	
CARBURATORE	
*YAMAHA PW 50	
111050	OEM : 5PG141010000



CARBURATEUR	
CARBURATORE	
*YAMAHA PW 80	
111050A	

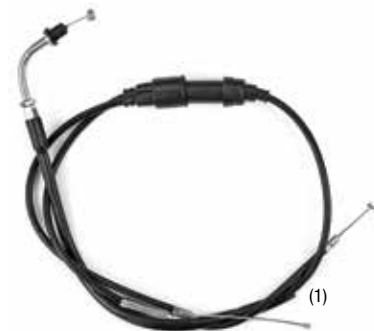

TRANSMISSION CABLE	
CAVO TRASMISSIONE	
*YAMAHA PW 50 / 80	
164301	GAZ COMPLETE - PW 50 (1)
164301A	STARTER COMPLETE - PW 50/80
164607	FREIN ARRIERE - PW 50
164607A	FREIN AVANT - PW 50



FILTRE A AIR	
FILTRO ARIA	
*YAMAHA PW 50	
114070	



BOUGIE	
CANDELA	
*YAMAHA PW 50	
S404	NGK BPR4HS



POCHETTE JOINT MOTEUR COMPLET	
KIT GUARNIZIONI COMPLETO	
*YAMAHA PW 50	
072032J	



BOBINE HAUTE TENSION	
BOBINA	
*YAMAHA PW 50	
180299	*YAMAHA PW 50



CDI	
CDI	
*YAMAHA PW 50	
111050	OEM : 5PG855900000



JEU DE DIRECTION	
DIRECTION BEARING SET	
*YAMAHA PW 50	
290215A	

* Adaptable
* Adattabile

Les références du constructeur sont seulement indicatives et n'impliquent pas que les pièces de rechange viennent du constructeur.
I codici di riferimento originali sono indicativi e non implicano che i ricambi provengano necessariamente dalla stessa fabbrica del costruttore.

MOTEUR MOTORE
*YAMAHA PW 50/80

TNT
Original



KIT CARROSSERIE

KIT CARENA

*YAMAHA PW 50 4 PIECES

366201 BLEU BLU

366201A NOIR NERO



SELLE

SELLA

*YAMAHA PW 50

580125 NOIR NERO



RESERVOIR D'ESSENCE COMPLET

SERBATOIO COMPLETO

*YAMAHA PW 50

366201C



KIT CARROSSERIE

KIT CARENA

*YAMAHA PW 80V 2 PIECES

366201D BLEU BLU

366201E NOIR NERO



SELLE

SELLA

*YAMAHA PW 80

58012A NOIR NERO



RESERVOIR D'ESSENCE COMPLET

SERBATOIO COMPLETO

*YAMAHA PW 80

366201B



RETEMENT NOEND

COPPIA MANOPOLE

*YAMAHA PW 50

344330



PAIRE DE LEVIERS ALU

COPPIA LEVE

*YAMAHA PW 50

331820

PARTIE CYCLE

- > COURONNE, PIGNON & CHAÎNE
- > KIT CHAÎNE
- > CABLE TRANSMISSION
- > LEVIER
- > POIGNÉE DE GAZ
- > GUIDON
- > POTENCE
- > EMBOUT DE GUIDON
- > PROTEGE MAIN
- > REVETEMENT
- > RETROVISEUR
- > AMORTISSEUR
- > REHAUSSE AMORTISSEUR
- > ROULEMENT DE ROUE
- > JANTE
- > FOURCHE
- > TE DE FOURCHE
- > JEU DE DIRECTION
- > GARDE-BOUE
- > BEQUILLE
- > REPOSE PIED
- > IMMATRICULATION
- > PORTE-BAGAGES
- > SELLE
- > COUVRE SELLE
- > HOUSE
- > PARE-BRISE
- > TOP CASE

PARTI CICLISTA

- > CORONA, PIGNONE & CATENA
- > KIT CATENA
- > CAVO TRASMISSIONE
- > LEVE
- > MANOPOLA GAS
- > MANUBRIO
- > REGGI MANUBRIO
- > CONTRAPPESI MANUBRIO
- > PROTEGGI MANI
- > MANOPOLE
- > RETROVISORI
- > AMMORTIZZATORE
- > RIALZO AMMORTIZZATORE
- > CUSCINETTO RUOTA
- > CERCHIO
- > FORCELLA
- > PIASTRA FORCELLA
- > CUSCINETTI DI STERZO
- > PARAFANGO
- > CAVALLETTO
- > PEDALINE
- > PORTA TARGA
- > PORTAPACCHI
- > SELLA
- > COPRI SELLA
- > TELO COPRI MOTO
- > PARABREZZA
- > BAULETTO

PARTIE CYCLE PARTI CICLISTA

CHAINE CATENA



ATTACHE RAPIDE CHAINE ATTACCO RAPIDO CATENA

Code Codice	Qualité Qualià	Type Tipo
241045A	TNT Original Or renforcée Oro rinforzata	415
241016	TNT Original Or renforcée Oro rinforzata	420
241021	TNT Original Or renforcée oro rinforzata	428

CHAINE CATENA

Code Codice	Maillon Maglia	Qualité Qualià	Type Tipo
241044	116	renforcée rinforzata	415
241008	122	renforcée rinforzata	420
241009	124	renforcée rinforzata	420
241010	128	renforcée rinforzata	420
241011	130	renforcée rinforzata	420
241012	132	renforcée rinforzata	420
241014	136	renforcée rinforzata	420
241015	138	renforcée rinforzata	420
241020	138	renforcée rinforzata	428
241023	134	renforcée rinforzata	428
241024	132	renforcée rinforzata	428
241025	130	renforcée rinforzata	428

CHAINE CATENA



SARKANY 420 134 MAILLONS

CHAINE RENFORCEE

CATENA RINFORZATA

241017 BLEU BLU

241017A ROUGE ROSSO

241017B JAUNE GIALLO

241017C VERT VERDE

CARTER CHAINE & PIGNON CARTER CATENA @ PIGNONE



UNIVERSEL

PROTEGE CHAINE ALU
PROTEGGI CATENA ALLUMINIO

240010A ROUGE ANODISE ROSSO ANODIZZATO

240010B CARBON STYLE CARBONIO



*AM6

CACHE PIGNON ALU
COPRI PIGNONE ALLUMINIO

289077J BLEU ANODISE BLU ANODIZZATO

289077K ROUGE ANODISE ROSSO ANODIZZATO

289077L ARGENT ARGENTO

289077M CARBON STYLE CARBONIO



*AM6

CACHE PIGNON
COPRI PIGNONE

289077 BLEU ANODISE BLU ANODIZZATO

289077A ROUGE ANODISE ROSSO ANODIZZATO

289077B CHROME CROMO

289077C CARBON STYLE CARBONIO

PARTIE CYCLE PARTI CICLISTA

COURONNE CORONA

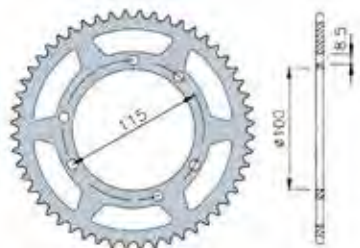

Code	Type	Z
264711	420	52

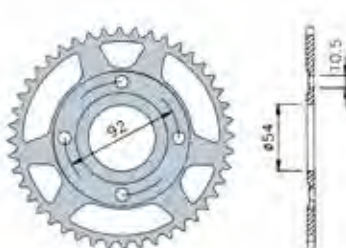

Code	Type	Z
264716	420	46

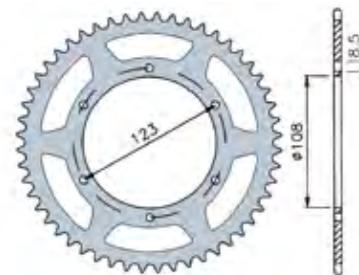

Code	Type	Z
264720	420	52

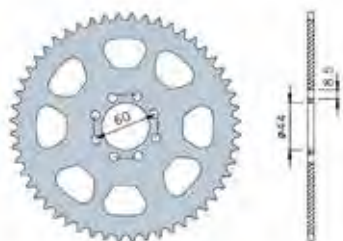

Code	Type	Z
264725	420	52

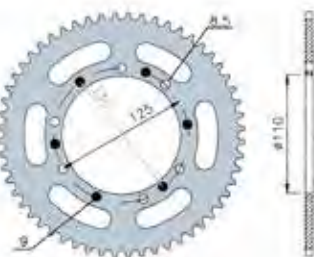

Code	Type	Z
264740	420	56

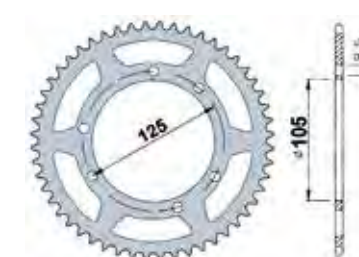

Code	Type	Z
264753	420	53

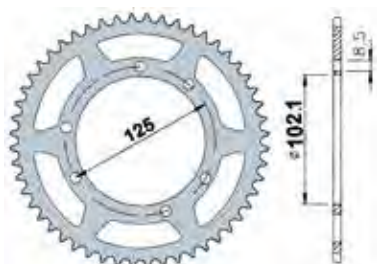

Code	Type	Z
264756	420	53

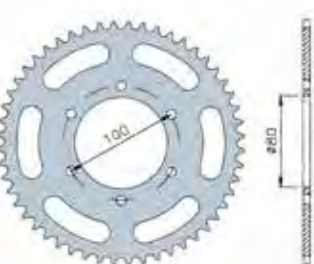

Code	Type	Z
264760	420	48

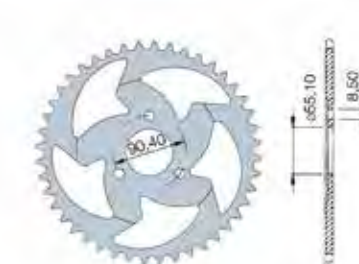

Code	Type	Z
264765A	420	47

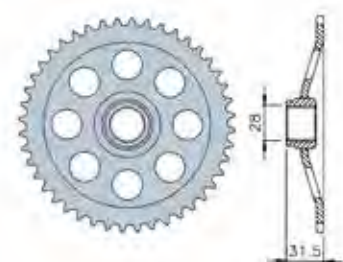

Code	Type	Z
264771	420	44

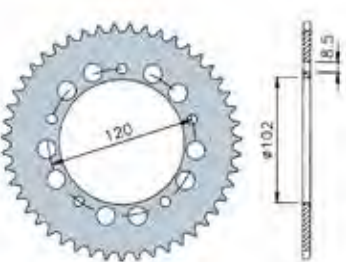

Code	Type	Z
264776	420	47

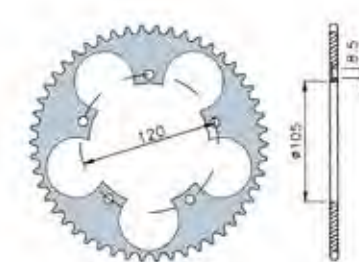

Code	Type	Z
264778	420	51

* Adaptable
* Adattabile

Les références du constructeur sont seulement indicatives et n'impliquent pas que les pièces de rechange viennent du constructeur.
I codici di riferimento originali sono indicativi e non implicano che i ricambi provengano necessariamente dalla stessa fabbrica del costruttore.

PARTIE CYCLE PARTI CICLISTA

COURONNE & PIGNON CORONA & PIGNONE

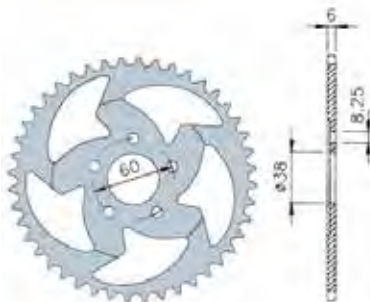

Code	Type	Z
264765	420	44



Code	Type	Z
264746A	428	48
264748A	428	53



PIGNON PIGNONE

Code	Modèle Moteur	Modello Motore	Type	Tipo	Z
260419	Minarelli AM6		420		11
260422	Minarelli AM6		420		12
260423	Minarelli AM6		420		13
260424	Minarelli AM6		420		14
260425	Minarelli AM6		420		15
260433	Minarelli AM6		428		15
260416	SENDA Euro2 / Euro3		420		13
260417	SENDA Euro2 / Euro3		420		14
260418	SENDA Euro2 / Euro3		420		15
260419	SENDA Euro2 / Euro3		420		16
260440	SENDA Euro2 / City 1&2		428		13
260441	SENDA Euro2 / City 1&2		428		14
260442	SENDA Euro2 / City 1&2		428		15
260414	SENDA FENIX		428		13

*MBK

S94564	MBK 51 BATONS ACIER Ø94 (10 T) 56DTS
S98481	MBK 51 BATONS ALU GRIMECA Ø98 (10 TR) 48DTS
S98529	MBK 51 BATONS ALU GRIMECA Ø98 (10 TR) 52DTS
S98549	MBK 51 BATONS ALU GRIMECA Ø98 (10 TR) 54DTS
S98569	MBK 51 BATONS ALU GRIMECA Ø98 (10 TR) 56DTS
S98601	MBK 51 BATONS ALU GRIMECA Ø98 (10 TR) 60DTS
S94565	MBK 51 Ø94 (11 TROUS) 56DTS
S94545	MBK 51 Ø94 (6/11 TROUS) 54DTS
S110545	MBK 88 Ø110 (6 TROUS) 54DTS
S94441	MBK Ø94 (6/11 TROUS) 44DTS
S98421	MBK Z Ø98 (10 TROUS) 42DTS
S98509	MBK Z Ø98 (10 TROUS) 50DTS

*PEUGEOT 102

Ø 81 (6 TROUS)
S81451 45 DTS

*PEUGEOT 103

BATONS ALU GRIMECA Ø 98 (10 TROUS)
S98391 39 DTS
S98427 42 DTS
S98457 45 DTS
S98487 48 DTS
S98507 50 DTS
S98527 52 DTS
S98541 54 DTS
S98567 56 DTS
S549860 60 DTS
103 BATONS TOLE Ø 94 (10 TROUS)
S94404 40 DTS
S94434 43 DTS
S94450 45 DTS
S94484 48 DTS
S94504 50 DTS
S94524 52 DTS
S94546 54 DTS
S94566 56 DTS
RAYONS Ø 94 (11 TROUS)
S94421 42 DTS
S94431 43 DTS
S94521 52 DTS
S94481 48 DTS
S94562 56 DTS



PIGNON PIGNONE

S531212 *MBK 51 12 DENTS



39 RÉFÉRENCES ADAPTABLES BOOSTER/BW'S 2004



PARTIE CYCLE PARTI CICLISTA

KIT CHAÎNE KIT CATENA PIGNONE CORONA



Cyl. Cil.	Modèle Modello	Année Anno	Réf. Codice
--------------	-------------------	---------------	----------------

APRILIA

50	MX, SM	03-06	244325
50	RS	95-98	244320
50	RS	99-05	244321 - 244322
50	RS	06-08	244323
50	RX	98-05	244325
50	RX	06-08	244323
50	Tuono	03-05	244321 - 244322

BULTACO

50	Astro SM	-	244305
50	Lobito	-	244305

CPI

50	Supermotard, Supercross	06	244530 - 244531
----	-------------------------	----	-----------------

DERBI

50	GPR Nude, Racing	04-05	244323
50		06-07	244323
50	Senda DRD Black Devil	04-05	244302 - 244303 - 244304
50	Senda R	00-02	244302 - 244303 - 244304
50	Senda R DRD Pro	06	244305
50	Senda R DRD Pro Racing	06	244305
50	Senda R X-Race	04-05	244302 - 244303 - 244304
50	Senda R X-Race	06-07	244302 - 244303 - 244304
50	Senda R X-Treme	02-05	244302 - 244303 - 244304
50	Senda R X-Treme	06-07	244302 - 244303 - 244304
50	Senda SM DRD	00-05	244305
50	Senda SM DRD Pro	06	244305
50	Senda SM DRD Racing	06	244305
50	Senda SM X-Race	04-05	244302 - 244303 - 244304
50	Senda SM X-Race	06-07	244302 - 244303 - 244304
50	Senda SM X-Treme	00-05	244302 - 244303 - 244304
50	Senda SM X-Treme	06-07	244302 - 244303 - 244304

GILERA

50	RCR, SMT	03-05	244302 - 244303 - 244304
50	RCR, SMT	06	244302 - 244303 - 244304

Cyl. Cil.	Modèle Modello	Année Anno	Réf. Codice
--------------	-------------------	---------------	----------------

HRD

50	Sonic	-	244530 - 244531
----	-------	---	-----------------

MBK

50	X-Limit Enduro	03-06	244347
50	X-Limit SM	97-98	244345 - 244346
50	X-Limit SM	02	244347
50	X-Limit SM	03-06	244347
50	X-Power	00-02	244340 - 244341
50	X-Power	03-05	244340 - 244341

PEUGEOT

50	XP6	95-98	244331
50	XP6 , XP6 SM	98-06	244333 - 244334
50	XR6	01	244333 - 244334
50	XR6	02-07	244335 - 244336
50	XPS , XPS SM	04-06	244333 - 244334

RIEJU

50	SMX/MRX	02-juin 04	244333 - 244334
50	SMX/MRX	juillet 04-06	244333 - 244334
50	MRX Pro	03-juin 04	244333 - 244334
50	MRX Pro	juillet 04-06	244333 - 244334
50	Spike	02	244370 - 244371
50	Spike	03-05	244370 - 244371
50	RS2 Matrix	03-04	244377
50	NKD	04	244377

TNT MOTOR

50	City (Dax)	-	244550 - 244550A
125	City (Dax)	-	244550B

YAMAHA

50	DTR R	97-98	244345 - 244346
50	DTR R	99-02	244345 - 244346
50	DTR R	03-06	244333 - 244334
50	DTR M	02	244325
50	DTR SM	03-05	244333 - 244334
50	TZR	97-06	244340 - 244341

PARTIE CYCLE PARTI CICLISTA

KIT CHAINE KIT CATENA PIGNONE CORONA

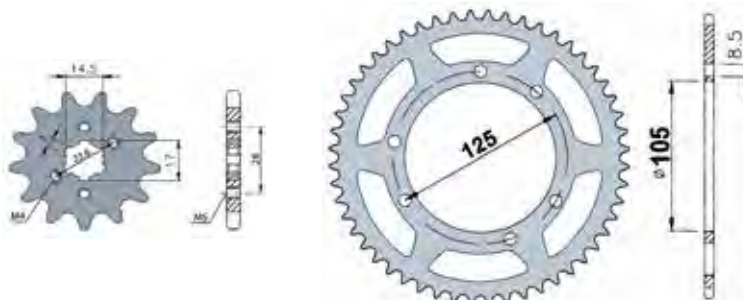

KIT CHAINE		KIT CATENA		PIGNON PIGNONE		COURONNE CORONA		CHAINE CATENA		
Code	Codice	Type	Tipo	Z	Code	Codice	Z	Code	Codice	
244302		420		13	260416		53	264753	130	241011
244303		420		14	260417		53	264753	130	241011
244304		420		15	260418		53	264753	130	241011

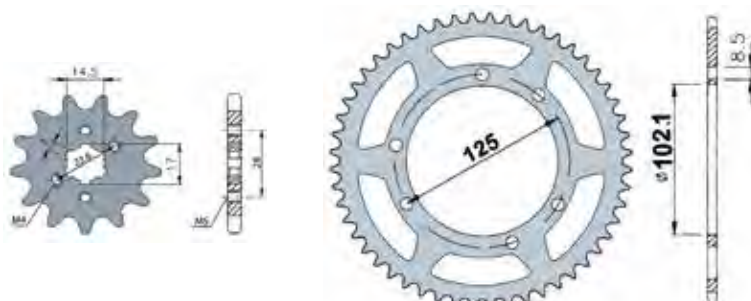

KIT CHAINE		KIT CATENA		PIGNON PIGNONE		COURONNE CORONA		CHAINE CATENA		
Code	Codice	Type	Tipo	Z	Code	Codice	Z	Code	Codice	
244305		420		14	260417		53	264756	136	241014

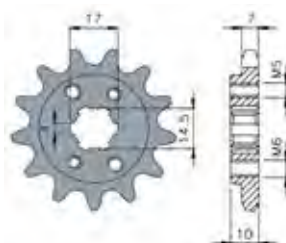

KIT CHAINE		KIT CATENA		PIGNON PIGNONE		COURONNE CORONA		CHAINE CATENA		
Code	Codice	Type	Tipo	Z	Code	Codice	Z	Code	Codice	
244301		420		13	241010		48	264746A		241010
244516		428		13	241025		53	264748A		241025

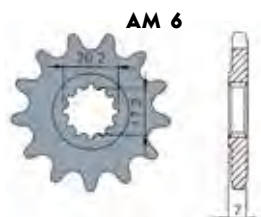

KIT CHAINE		KIT CATENA		PIGNON PIGNONE		CHAINE CATENA		
Code	Codice	Type	Tipo	Z	Code	Codice	Maillon Maglia	
244320		420		12	260422		122	241008

* Adaptable
* Adattabile

Les références du constructeur sont seulement indicatives et n'impliquent pas que les pièces de rechange viennent du constructeur.
I codici di riferimento originali sono indicativi e non implicano che i ricambi provengano necessariamente dalla stessa fabbrica del costruttore.

PARTIE CYCLE PARTI CICLISTA

KIT CHAINE KIT CATENA PIGNONE CORONA

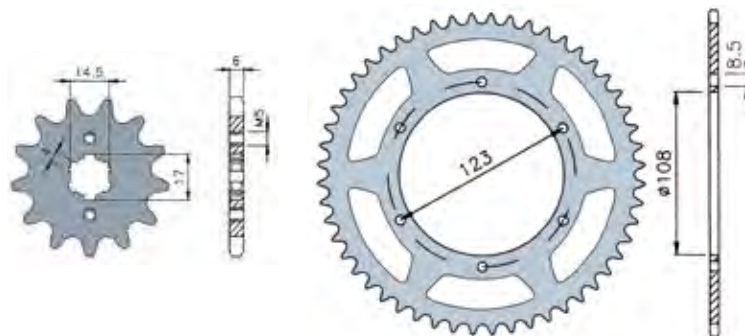

KIT CHAINE		KIT CATENA		PIGNON PIGNONE		COURONNE CORONA		CHAINE CATENA		
Code	Codice	Type	Tipo	Z	Code	Codice	Z	Code	Codice	
244323		420		13	260416		52	264720	132	241012

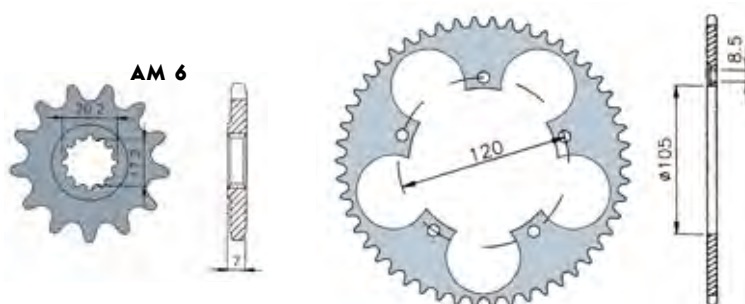

KIT CHAINE		KIT CATENA		PIGNON PIGNONE		COURONNE CORONA		CHAINE CATENA		
Code	Codice	Type	Tipo	Z	Code	Codice	Z	Code	Codice	
244325		420		12	260422		51	264778	128	241010

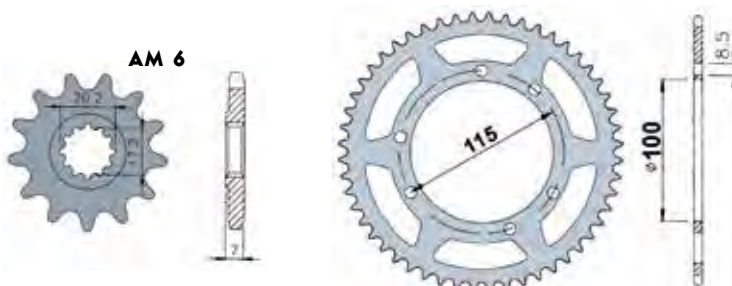

KIT CHAINE		KIT CATENA		PIGNON PIGNONE		COURONNE CORONA		CHAINE CATENA		
Code	Codice	Type	Tipo	Z	Code	Codice	Z	Code	Codice	
244331		420		12	260422		52	264711	124	241009

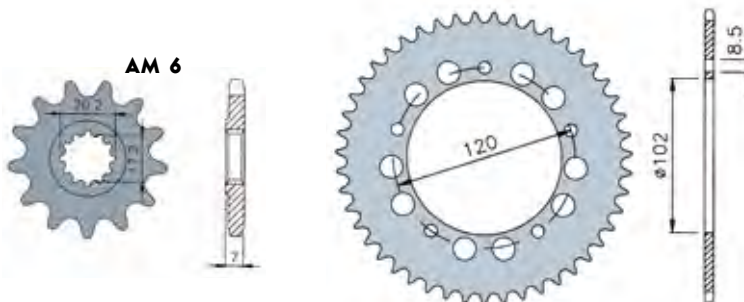

KIT CHAINE		KIT CATENA		PIGNON PIGNONE		COURONNE CORONA		CHAINE CATENA		
Code	Codice	Type	Tipo	Z	Code	Codice	Z	Code	Codice	
244321		420		12	260422		47	264776	122	241008
244322		420		13	260423		47	264776	122	241008

PARTIE CYCLE PARTI CICLISTA

KIT CHAINE KIT CATENA PIGNONE CORONA

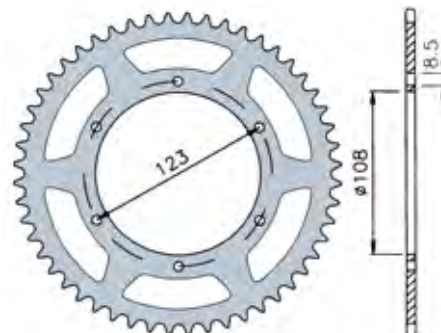
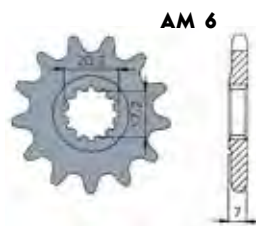

KIT CHAINE		KIT CATENA		PIGNON	PIGNONE	COURONNE		CORONA		CHAINE		CATENA	
Code	Codice	Type	Tipo	Z	Code	Codice	Z	Code	Codice	Maillon	Maglia	Code	Codice
244335		420		12	260422		52	264720		128		241010	
244336		420		13	260423		52	264720		128		241010	

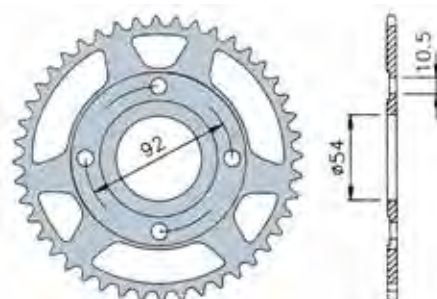
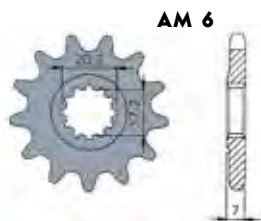

KIT CHAINE		KIT CATENA		PIGNON	PIGNONE	COURONNE		CORONA		CHAINE		CATENA	
Code	Codice	Type	Tipo	Z	Code	Codice	Z	Code	Codice	Maillon	Maglia	Code	Codice
244340		420		12	260422		46	264716		132		241012	
244341		420		13	260423		46	264716		132		241012	

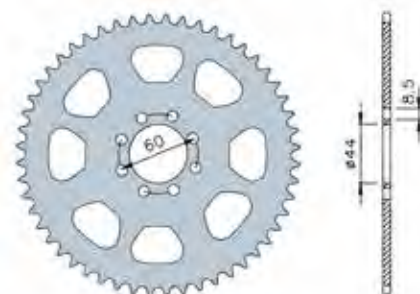
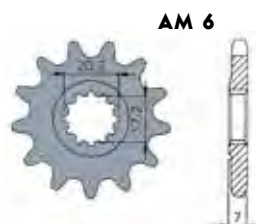

KIT CHAINE		KIT CATENA		PIGNON	PIGNONE	COURONNE		CORONA		CHAINE		CATENA	
Code	Codice	Type	Tipo	Z	Code	Codice	Z	Code	Codice	Maillon	Maglia	Code	Codice
244345		420		12	260422		52	264725		128		241010	
244346		420		13	260423		52	264725		128		241010	

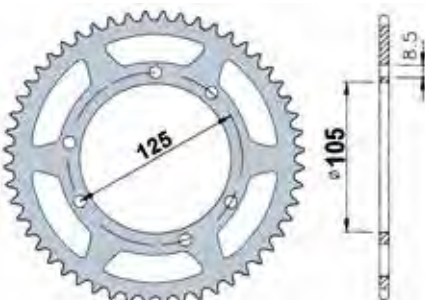
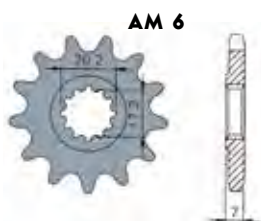

KIT CHAINE		KIT CATENA		PIGNON	PIGNONE	COURONNE		CORONA		CHAINE		CATENA	
Code	Codice	Type	Tipo	Z	Code	Codice	Z	Code	Codice	Maillon	Maglia	Code	Codice
244333		420		12	260422		53	264753		128		241010	
244334		420		13	260423		53	264753		128		241010	

* Adaptable
* Adattabile

Les références du constructeur sont seulement indicatives et n'impliquent pas que les pièces de rechange viennent du constructeur.
I codici di riferimento originali sono indicativi e non implicano che i ricambi provengano necessariamente dalla stessa fabbrica del costruttore.

PARTIE CYCLE PARTI CICLISTA

KIT CHAINE KIT CATENA PIGNONE CORONA

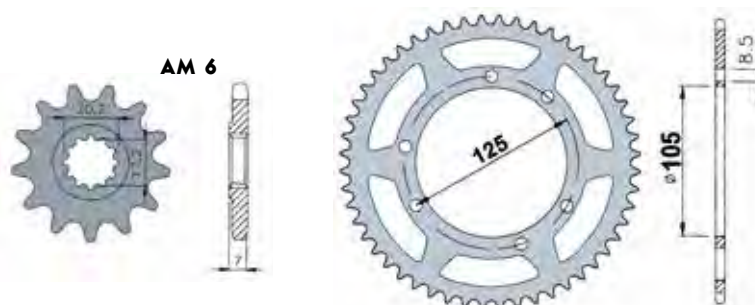

KIT CHAINE		KIT CATENA		PIGNON PIGNONE		COURONNE CORONA		CHAINE CATENA		
Code	Codice	Type	Tipo	Z	Code	Codice	Z	Code	Codice	
244347		420		13	260423		53	264753	128	241010

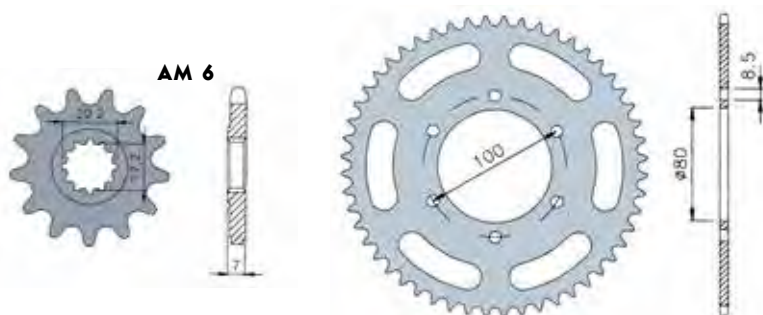

KIT CHAINE		KIT CATENA		PIGNON PIGNONE		COURONNE CORONA		CHAINE CATENA		
Code	Codice	Type	Tipo	Z	Code	Codice	Z	Code	Codice	
244370		420		12	260422		48	264760	124	241009
244371		420		13	260423		48	264760	124	241009

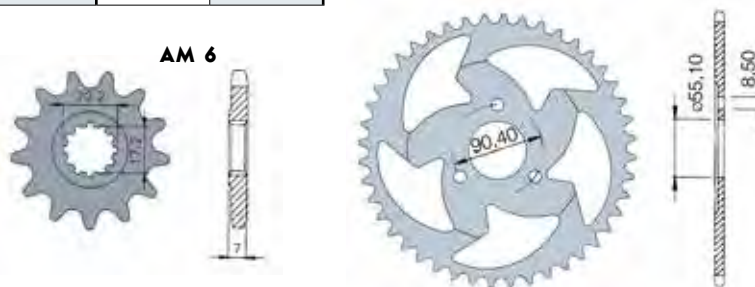

KIT CHAINE		KIT CATENA		PIGNON PIGNONE		COURONNE CORONA		CHAINE CATENA		
Code	Codice	Type	Tipo	Z	Code	Codice	Z	Code	Codice	
244376		420		13	260423		44	264765	128	241010
244377		420		13	260423		47	264765A	128	241010

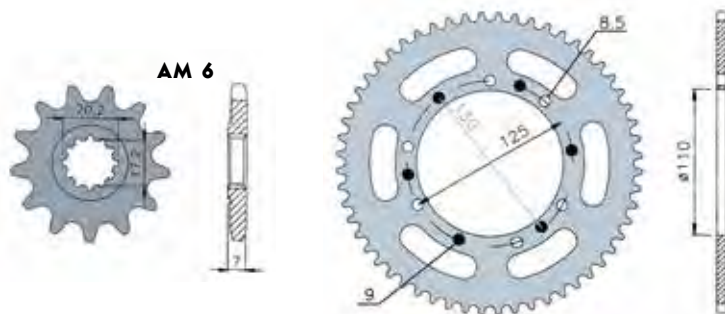

KIT CHAINE		KIT CATENA		PIGNON PIGNONE		COURONNE CORONA		CHAINE CATENA		
Code	Codice	Type	Tipo	Z	Code	Codice	Z	Code	Codice	
244530		420		12	260422		56	264740	138	241015
244531		420		13	260423		56	264740	138	241015

PARTIE CYCLE PARTI CICLISTA

KIT CHAINE KIT CATENA PIGNONE CORONA

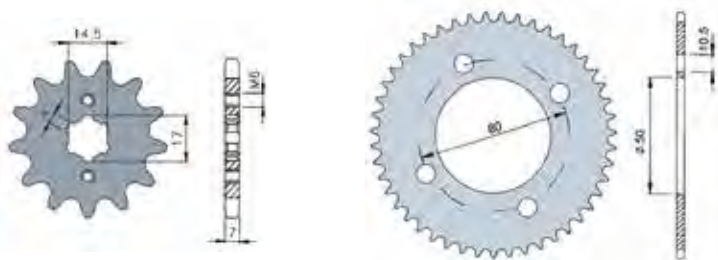

KIT CHAINE		KIT CATENA		PIGNON		PIGNONE		COURONNE		CORONA		CHAINE		CATENA	
Code	Codice	Type	Tipo	Z	Code	Codice	Z	Code	Codice	Maillon	Maglia	Code	Codice		
244550		428		13			32			122		241029			
244550A		428		14	260441		32			122		241029			
244550B		428		15	260442		32			122		241029			

CABLE TRANSMISSION CAVO TRASMISSIONE



SERRE-CABLE & TENDEUR DE GAINÉ SERRA-CAVO & TENDITORE GUAINA

320090	LAITON	(1)
170410	DECOMPRESSEUR	(2)
170411	FREIN	(3)
170100	M86	(4)
170101	TARGA	(5)
170101A	TARGA M6	
323500A	M10 X 16 MM	(6)
S429	MOTO 3 MM (X2)	(7)
S426	MOTO 3 MM (X3)	
S428		(8)
S2103	FREIN MBK	(9)
S4281	GAZ MAGURA	(10)
S542923	GAZ PEUGEOT	(11)
S424	TAMBOUR GM	(12)

FIXATION CABLE FREIN SCOOTER FISSAGGIO CAVO FRENO SCOOTER

165000	LARGE	LARGO
165001	ETROIT	STRETTO



KIT GAINÉ + CABLE KIT GUAINA + CAVO

162504 NOIR NERO



KIT REPARATION CABLE GAZ & EMBR. KIT RIPARAZIONE CAVO GAS & FRIZ.

160070



GAINÉ GUAINA

161000	CHROM (25 M)
162105	CHROM (6,25 M)
162002	NOIR NERO 32/10 (16,5 M) (1)
S66001	NOIR NERO 30/10 (25 M)
162003	NOIR NERO (25 M)

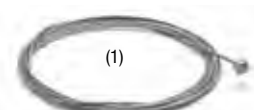

BOITE DE CABLES CAVO

160025	CARBU STAND 1,60 M
160030	FREIN WEINM 1,80 M (1)
160040	FREIN ARR MBK 51 1,80 M
160060	FREIN ARR 103 1,80 M
S29250	FREIN MOTO 23/10ème
160065	CARBU PEUGEOT 1,20 M
160066	EMBRAYAGE 8X8X2M
S223120	DECOMPRESSEUR MBK 1,20 M
S34120	GAZ CIAO 1,20 M
S342001	GAZ CIAO/DELL'ORTO 2,50 M
S204120	GAZ MBK 1,20 M
S204251	GAZ MBK 2,50 M
S210200	PEUGEOT 2,00 M

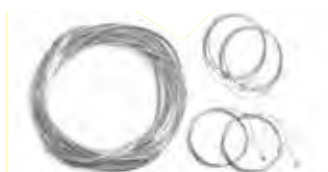

KIT GAINÉ + CABLE KIT GUAINA + CAVO

162505 CHROME CROMO



KIT REPARATION CABLE GAZ DELLORTO KIT RIPARAZIONE CAVO GAS DELLORTO

160070B L.2,50M Ø1,2MM + SERRE CABLE

TENDEUR DE GAINÉ TENDITORE GUAINA



TENDEUR DE CABLE REGLABLE TENDITORE GUAINA

323500 M10

* Adaptable
* Adattabile

Les références du constructeur sont seulement indicatives et n'impliquent pas que les pièces de rechange viennent du constructeur.
I codici di riferimento originali sono indicativi e non implicano che i ricambi provengano necessariamente dalla stessa fabbrica del costruttore.

PARTIE CYCLE PARTI CICLISTA

CABLE TRANSMISSION CAVO TRASMISSIONE

TNT
Original



COMPTEUR TACHIMETRO	GAZ SUPERIEUR GAS SUPERIORE	GAZ INFERIEUR GAS BOTTOM GAS INFERIORE	GAZ COMPLET GAS COMPLETO	GAZ POMPE GAS POMPA	FREIN AVANT FRENO ANT	FREIN ARRIERE FRENO POST	EMBRAYAGE FRIZIONE	STARTER STARTER
------------------------	--------------------------------	--	-----------------------------	------------------------	--------------------------	-----------------------------	-----------------------	--------------------

APRILIA								
50	SR 97			164745			164635	
50	RS 50	164535		164406			164407	
CPI								
50	SCOOTER	164531		164359			164642	
MBK / YAMAHA								
50	BOOSTER / BW'S	164500 OM		164699 COMPET.			164601	164335A
50	BOOSTER / BW'S 2004	164506		164335B			164601A	
50	SPIRIT	164501	164334	164335			164601	164335A
50	NEXT GENERATION	164502		164335			164602	
50	NITRO / AEROX	164505		164356				
50	AEROX / NITRO NM	164531						
50	OVETTO / NEOS	164506		164358			164605	
50	OVETTO / NEOS 2008	164506A						
50	STUNT	164502	164334	164335			164603	
50	MBK XPOWER			164770				164900
100	BOOSTER	164549C						
125	FLAME	164549D						
125/150	SKYLINER	164549E		164750			164645	
50	XLIMIT / DT 50R>2008			164770A				164900A
PEUGEOT								
50	BUXY	164520	164720				S164347	
50	MBK XPOWER			164770				164900
50	SQUAB / TREKKER	164521	164726				164616	
50	SPEEDFIGHT	164522	164723				164615/164616	
50	LUDIX SNAKE						164615	
50	LUDIX	164522A		164333		164600A	164615A	
50	VIVACITY	164549F						
50	103 MVL 110KM/H							
50	103 SPX FOX	164547						
50	PEUGEOT XP6 AM		164771	164771				164901
50	PEUGEOT XP6 NM	164523		164731				164901
50	FOX			164729		164619	164618	
125	ELYSEO	164549G						
PIAGGIO								
50	TYPHOON / NRG / NTT	164530	164740		164741		164631	
50	NRG MC2	164549H						
50	NRG MC3	164549I						
50	GILERA RUNNER	164545	164760	164761			164640	
50	GILERA STALKER	164546	164755				164641	
50	LEONARDO	164549A						
50	ET2 / ET4	164549B						
50	ZIP 2T/4T	164530A						
50-200	LIBERTY	164549						
125/200	X9			164750B				
125/200	EVO			164750B				
SUZUKI								
125	BURGMAN	164549J						
HONDA								
125/150	SH	164549K		164750A			164645A	
DERBI								
50	SENDA AM EURO2	164403		164401				164400
50	SENDA NM EURO3	164548		164402A				164400A
RIEJU								
50	MRT							164902
YAMAHA								
50	PW 50			164301		164607A	164607	164301A
SCOOTER CHINOIS CHINESE SCOOTER								
		164503	Carré / Carré 980 mm	164360 (192CM)			164606 (192CM)	
		164503A	Carré / Fendu 925 mm	164360A (199CM)				
		164503B	Type 3	164360 (192CM)				
		164503C	Type 4	164360A (199CM)				

➤ **LEVIER TUNING LEVE TUNING**



***CPI SCOOTERS X2**
 332035B BLANC BIANCO
 332035D ALU POLI ALLUMINIO

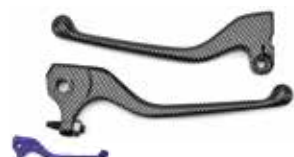

***BOOSTER 2003 X2**
 332030 BLEU BLU
 332032 CARBON STYLE CARBONIO



***BOOSTER 2004 X2**
 332027A BLANC BIANCO
 332028 CARBON STYLE CARBONIO



***BOOSTER NEXT 99 / ROCK 99 X2**
 332001A BLANC BIANCO
 332000 CARBON STYLE CARBONIO



***BOOSTER SPIRIT 99 X2**
 332004A BLANC BIANCO
 332007 CARBON STYLE CARBONIO



***BOOSTER SPIRIT X2**
 332010 CARBON STYLE CARBONIO



***APRILIA SR STEALTH X2**
 332094 CARBON STYLE CARBONIO



***MACH G / JOG-R X2**
 332167B CARBON STYLE CARBONIO
 332167C ALU POLI ALLUMINIO
 332167D BLANC BIANCO



***NITRO / AEROX X2**
 332024 CARBON STYLE CARBONIO
 332025A BLANC BIANCO



***OVETTO / NEOS X2**
 332021 BLEU BLU



***PEUGEOT AJP X2**
 332070 CARBON STYLE CARBONIO
 332071A BLANC BIANCO



***PEUGEOT HENGTONG X2**
 332079 CARBON STYLE CARBONIO



***ROCKET 97/98 X2**
 332017 CARBON STYLE CARBONIO



***RUNNER 1 DISC X2**
 332155 CARBON STYLE CARBONIO



***RUNNER 2 DISC X2**
 332152 CARBON STYLE CARBONIO
 332150 NOIR NERO



***SPEEDFIGHT H20 X2**
 332080 CARBON STYLE CARBONIO



***STALKER X2**
 332160 NOIR NERO
 332162 CARBON STYLE CARBONIO



***STUNT / SLIDER X2**
 332028 CARBON STYLE CARBONIO
 332027A BLANC BIANCO



***TYPHOON X2**
 332044 CARBON STYLE CARBONIO
 332041A BLANC BIANCO

➤ **LEVIER TYPE ORIGINE LEVA TIPO ORIGINALE**



***CPI / KEEWAY / GENERIC**

331719 GAUCHE SINISTRA

331718 DROITE DESTRA



***NITRO / AEROX**

331815 GAUCHE SINISTRA

331815 DROITE DESTRA



***BOOSTER 2004**

331724 GAUCHE SINISTRA

331816 DROITE DESTRA



***STUNT / SLIDER**

331724 GAUCHE SINISTRA

331816 DROITE DESTRA



***BOOSTER / BW'S 2000**

331724 GAUCHE SINISTRA

331725 DROITE DESTRA



***STUNT / SLIDER**

331817A GAUCHE SINISTRA ALU

331816A DROITE DESTRA ALU



***BOOSTER SPIRIT**

331707 GAUCHE SINISTRA

331708 DROITE DESTRA



***SPEEDFIGHT**

331717 GAUCHE SINISTRA

331811 DROITE DESTRA



***BOOSTER NEXT GENERATION**

331714 GAUCHE SINISTRA

331713 DROITE DESTRA



***TYPHOON / NRG**

331720 GAUCHE SINISTRA

331721 DROITE DESTRA



***OVETTO / NEOS**

331723 GAUCHE SINISTRA

331722 DROITE DESTRA



***TWEET 50**

331652D GAUCHE SINISTRA

331652E DROITE DESTRA



***KYMCO AGILITY 4T 50/125**

331652B GAUCHE SINISTRA

331652C DROITE DESTRA



***BUXY / SPEEDAKE**

331717 GAUCHE SINISTRA

***SPEEDFIGHT AJP**

331717 GAUCHE SINISTRA



***KISBEE 50**

331652F GAUCHE SINISTRA

331652G DROITE DESTRA



***PIAGGIO ZIP 50 / STALKER / NRG**

331720A GAUCHE SINISTRA

331721A DROITE DESTRA



***SYM MIO 50**

331652H GAUCHE SINISTRA

331652I DROITE DESTRA



***SYM ORBIT 50**

331652J GAUCHE SINISTRA

331652K DROITE DESTRA



***ELYSTAR 50**

331655B DROITE DESTRA & GAUCHE SINISTRA

PARTIE CYCLE PARTI CICLISTA

LEVIER SCOOTER & MAXI SCOOTER LEVE SCOOTER & MAXI SCOOTER

> LEVIER GAUCHE LEVA SINISTRA



***BOOSTER SPIRIT**
331280



***BOOSTER 2004 / NEXT / STUNT**
331280A



***BOOSTER / NEXT**
331280B



***TREKKER / VIVACITY**
331281



***TYPHOON**
331282



***OVETTO**
331283



***DERBI SENDA R DRD-XTREM-RACER**
331285



***MBK MACH G / JOG R**
331280C



***PIAGGIO FLY 4T / LIBERTY / TYPHOON / LX 2T-4T**
331280D

> LEVIER TYPE ORIGINE MAXI SCOOTER LEVA ORIGINALE



***X-MAX 125cc**
331661 GAUCHE SINISTRA



331661A DROITE DESTRA



***T-MAX 500**
331659 GAUCHE SINISTRA



331659A DROITE DESTRA



***HONDA DILAN 125cc**
331651 GAUCHE SINISTRA



331651A DROITE DESTRA



***T-MAX 500 / 530 2008>**
331659B GAUCHE SINISTRA



331659C DROITE DESTRA



***HONDA PCX 125**
331661B GAUCHE SINISTRA



331661C DROITE DESTRA



***HONDA SH 300**
331651D GAUCHE SINISTRA



331651E DROITE DESTRA



***KYMCO AGILITY 4T 50/125cc**
331652B GAUCHE SINISTRA



331652C DROITE DESTRA



***ET2 / ET4 / LIBERTY**
331656 GAUCHE SINISTRA



331656A DROITE DESTRA



***BURGMAN AN 650**
331657C GAUCHE SINISTRA



331657B DROITE DESTRA



***SATELIS 125CC**
332175



X2



***X9 / SKYLINER 125cc 98>01**
331654B GAUCHE SX & DROITE DX



***BURGMAN UH 125**
331657A DROITE DESTRA



***ELYSEO 125cc AJP**
331655A GAUCHE SX & DROITE DX



***ELYSEO 125cc**
331655 GAUCHE SX & DROITE DX

> LEVIER TUNING MAXI SCOOTER LEVE TUNING



***T-MAX 2001 > 2007** X2
368000H CARBON STYLE



***T-MAX 2001 > 2007** X2
368000I CARBON STYLE



***T-MAX 500 / 530 2008** X2
331659F ALU

* Adaptable
* Adattabile

Les références du constructeur sont seulement indicatives et n'impliquent pas que les pièces de rechange viennent du constructeur.
I codici di riferimento originali sono indicativi e non implicano che i ricambi provengano necessariamente dalla stessa fabbrica del costruttore.

PARTIE CYCLE PARTI CICLISTA

LEVIER TUNING 50CC A BOITE LEVA TUNING 50CC A MARCE

> LEVIER TYPE ORIGINE ORIGINAL STYLE LEVER



***APRILIA RS**

331803 EMBRAYAGE FRIZIONE

331802 DROITE DESTRA



***DERBI SENDA**

331800 EMBRAYAGE FRIZIONE

331801 DROITE DESTRA



***APRILIA RS 2003/2004**

331803A EMBRAYAGE FRIZIONE

331802A DROITE DESTRA



***CPI SX/SM/SMX**

331805 EMBRAYAGE FRIZIONE

331805A DROITE DESTRA



***MBK XPOWER**

331819 EMBRAYAGE FRIZIONE

331818 DROITE DESTRA



***DERBI SENDA 2004**

331800A EMBRAYAGE FRIZIONE

***DERBI SENDA DRD**

331801A DROITE DESTRA



***X-LIMIT > 2003 / DT > 2003**

331804 EMBRAYAGE FRIZIONE

***RIEJU 50 MX / SM / RR**

331806 EMBRAYAGE FRIZIONE



***DERBI SENDA 2003**

331724 EMBRAYAGE FRIZIONE

> LEVIER TUNING LEVA TUNING



***APRILIA RS > 99**

X2

332097 ALU POLI ALLUMINIO
332099 CARBON STYLE CARBONIO

***DERBI SENDA / RMX**

X2

332116 BLEU BLU
332117 ROUGE ROSSO
332118 CARBON STYLE CARBONIO



***DERBI SENDA DRD**

X2

332116B BLANC BIANCO
332118A CARBON STYLE CARBONIO

***DERBI SENDA >2003**

X2

332120A BLANC BIANCO
332120B ROUGE ROSSO
332120C CARBON STYLE CARBONIO



CROSS / ENDURO

X2

331500 NOIR NERO ANODIZZATO
331500A BLEU ANODISE BLU ANODIZZATO
331500B ROUGE ANODISE ROSSO ANODIZ

***X-LIMIT > 2003 / DT > 2002**

X2

332121 BLEU BLU
332121A BLANC BIANCO
332121B ROUGE ROSSO
332121C CARBON STYLE CARBONIO
332121D ALU POLI ALLUMINIO



***XLIMIT / DT / RS**

X2

332089 CARBON STYLE CARBONIO
332090A BLANC BIANCO

***XPOWER**

X2

332166 CARBON STYLE CARBONIO



***CROSS ENDURO**

331500C REGLABLE REGOLABILE

PARTIE CYCLE PARTI CICLISTA
LEVIER CYCLO MOPED LEVER

➤ **LEVIER TYPE ORIGINE LEVA TIPO ORIGINALE**



***PEUGEOT MVL / FOX** X2
 331600 ALU ALLUMINIO



X2
 331273 ALU NOIR ALLUM. NERO
 331275 ALU CHROM ALLUM. CROMO



***PEUGEOT MVL / FOX** X2
 331133 PLASTIQUE PVC NERO



DECOMPRESSEUR
 330493 NYLON NOIR NYLON NERO
 330603 ZAMAC NOIR ZAMAC NERO
 330605 ZAMAC CHROM ZAMAC CROMO

➤ **POIGNÉE DE GAZ COMANDO GAS SCOOTER**
 ➤ **SCOOTER**



***BOOSTER SPIRIT**
 323422



***BOOSTER 2004 / NEXT / STUNT**
 323422B



***OVETTO / NEOS 50**
 323425



***TREKKER / VIVACITY**
 323423



***TYPHOON**
 323424

➤ **CYCLO CICLOMOTORE**



TARGA
 323159 CHROME / NOIR CROMO / NERO
 323153 NOIR NERO
 323200 COUVERCLE TRASPARENT COPERCHIO (1)



MINI TARGA
 323353
 320003 PLASTIQUE PVC
 323205 COUVERCLE TRASPARENT TCOPERCHIO (1)



LARIO STYLE
 323400 CHROME / NOIR CROMO / NERO

* Adaptable
 * Adattabile

Les références du constructeur sont seulement indicatives et n'impliquent pas que les pièces de rechange viennent du constructeur.
 I codici di riferimento originali sono indicativi e non implicano che i ricambi provengano necessariamente dalla stessa fabbrica del costruttore.

PARTIE CYCLE PARTI CICLISTA
50CC A BOITE 50CC A MARCE

TNT
Original

COMANDI MOTO
domino



ENDROSS CROSS
323421



ENDROSS CROSS ECO
323421E



UNIVERSEL
323300C



FORMULA CROSS
323421F



FORMULA CROSS ECO
323421C



PIT BIKE
323300I REGLABLE REGOLABILE



COMMANDO
323420



COMMANDO ECO
323420A



PIT BIKE
323300J



HR 2 TEMPS CROSS
323421A



ALU END



ALU TIRAGE HORLOGE ALLUMINIO
 323300E BLEU BLU
 323300F ROUGE ROSSO
 323300G ARGENT ARGENTO
 323300H NOIR NERO



TNT
Tuning



ALU CNC ALLUMINIO CNC
 323300 BLEU BLU
 323300A ROUGE ROSSO
 323300B ARGENT ARGENTO
 323300D NOIR NERO
 323300K OR ORO



PARTIE CYCLE PARTI CICLISTA

GUIDON MANUBRIO

> STREET BIKE



Ø 22 MM

ALU ALLOY
303244 BLANC BIANCO
303245 BLEU BLU
303246 ROUGE ROSSO
303246A ORANGE ARANCIONE
303247 VERT VERDE
303248 ARGENT ARGENTO
303249 CARBONE STYLE CARBONIO
303250 NOIR MAT NERO OPACO



OVERSIZE Ø 28,6 MM

ALU ALLOY
303243 BLEU BLU
303243B ARGENT ARGENTO
303243C CARBONE STYLE CARBONIO
303243D NOIR MAT NERO OPACO
303243E BLANC BIANCO

> CROSS



OFF ROAD Ø 22 MM

ALU ALLOY
303202 OR ORO
303203 ARGENT ARGENTO
303204 BLEU BLU
303205 CARBONE STYLE CARBONIO
303207 ROUGE ROSSO
303207B ORANGE ARANCIONE
303208 STYLE TITANE TITANIO
303209 NOIR MAT NERO OPACO



OVERSIZE Ø 28,6 MM

ALU ALLOY
303260A ARGENT ARGENTO
303260B NOIR MAT NERO OPACO

> CYCLO CICLOMOTORE



RACING

ACIER CHROME ACCIAIO CROMO
301894 Ø 26/28
301892 Ø 28/30
301893 Ø 32/35

Z BAR

ACIER ACCIAIO
301897 CHROME CROMO



> PONTET DE GUIDON ALU SUPPORTI MANUBRIO ALLUM.



N



Ø28,6

303196 ARGENT ARGENTO
303196A NOIR ANODISE NERO ANODIZZATO
303196B OR ORO

X2

* Adaptable
* Adattabile

Les références du constructeur sont seulement indicatives et n'impliquent pas que les pièces de rechange viennent du constructeur.
I codici di riferimento originali sono indicativi e non implicano che i ricambi provengano necessariamente dalla stessa fabbrica del costruttore.

PARTIE CYCLE PARTI CICLISTA

GUIDON MANUBRIO

> PONTET DE GUIDON ALU SUPPORTI MANUBRIO ALLUM.



LIGHTY

	55/70 (1)	70/85 (2)
BLEU ANODISE BLU ANODIZZATO	303198	303197
ROUGE ANODISE ROSSO ANODIZZATO	303198A	303197A
CARBONE STYLE CARBONIO	303198B	303197B



Ø 22 MM

	BAS BASSO (1)	HAUT ALTO (2)
ARGENT ARGENTO	303200A	303199A
NOIR MAT NERO OPACO	303200C	303199C

> POTENCE SCOOTER SUPPORTO MANUBRIO



ALU ALLUMINIO Ø 22 MM

	*BOOSTER STUNT	*NITRO AEROX/CPI	*SPEED-FIGHT	*TYPHOON NRG	*LUDIX (1)
BLEU BLU	303300	303311			
ROUGE ROSSO	303301		303323	303325B	
NOIR MAT NERO OPACO	303305	303315	303320		
BLANC BIANCO	303307	303313	303323A	303325D	303326D
ARGENT ARGENTO	303303	303310	303321	303325A	303326A
CARBONE STYLE CARBONIO	303304	303314		303325C	303326B

> EMBOUT DE GUIDON CONTRAPPESI MANUBRIO



HOLE

30008B NOIR MAT NERO OPACO

X2

CONICAL

300021 BLEU BLU
300023 ROUGE ROSSO
300024 CARBONE STYLE CARBONIO

X2

T-MAX MAXI SCOOT

368000E CHROM
368000F CARBONE STYLE CARBONIO

X2

CROSS

300030 ALU ALLUMINIO

X2

PARTIE CYCLE PARTI CICLISTA

GUIDON MANUBRIO

> MOUSSE DE GUIDON SPUGNA MANUBRIO



MOUSSE DE GUIDON 240 x 178

SPUGNA MANUBRIO

M004450D	BLEU / BLANC	BLU / BIANCO
M004450A	NOIR / JAUNE	NERO / GIALLO
M004450B	NOIR / VERT FLUO	NERO / VERDE
M004450C	ROUGE / BLANC	ROSSO / BIANCO



MOUSSE DE GUIDON 185 x 178

SPUGNA MANUBRIO

M004450H	BLEU / BLANC	BLU / BIANCO
M004450E	NOIR / JAUNE	NERO / GIALLO
M004450F	NOIR / VERT FLUO	NERO / VERDE
M004450G	ROUGE / BLANC	ROSSO / BIANCO



MOUSSE DE GUIDON 160 x 247

SPUGNA MANUBRIO

M004450L	BLEU / BLANC	BLU / BIANCO
M004450J	NOIR / JAUNE	NERO / GIALLO
M004450I	NOIR / VERT FLUO	NERO / VERDE
M004450K	ROUGE / BLANC	ROSSO / BIANCO

> ROUE CERCHIO

> COUVRE RAYON COPRI RAGGI



COUVRE RAYON

COPRI RADDI

38 PIECES ROUE 19" ET 38 PIECES ROUE 21"

38 PEZZI CERCHIO 19" E 38 PEZZI CERCHIO 21"

M004451 ORANGE FLUO ARANCIONE

M004451A JAUNE FLUO GIALLO

M004451B ROSE FLUO ROSA

M004451C BLANC BIANCO

M004451D VERT FLUO VERDE

M004451E BLEU BLU

M004451F ROUGE ROSSO

PARTIE CYCLE PARTI CICLISTA
PROTEGE MAIN PROTEGGI MANI

> PROTEGE MAIN PROTEGGI MANI



RALLY		X2
303223	NOIR NERO	
303223A	BLANC BIANCO	
303223B	CARBONE STYLE CARBONIO	

> CROSS + MECABOITE 50CC A MARCE



CROSS		X2
303218	NOIR NERO	
303218A	BLANC BIANCO	
303218F	CARBONE STYLE CARBONIO	

CROSS		X2
303220A	BLANC BIANCO	
303220B	NOIR NERO	



CROSS		X2
303222	NOIR NERO	
303222A	BLANC BIANCO	

PARTIE CYCLE PARTI CICLISTA
REVETEMENT MANOPOLE

NOEND
Classic
 authentic rubber grip



NEW

CLASSIC DROP X2
 344231 NOIR NERO
 344231A CAMEL CAMELLO



NEW

CLASSIC KUST X2
 344232 NOIR NERO
 344232A CAMEL CAMELLO



NEW

CLASSIC ROCKET X2
 344230 NOIR NERO
 344230A CAMEL CAMELLO



NEW

CLASSIC SPEED X2
 344233 NOIR NERO
 344233A CAMEL CAMELLO



CLASSIC BOBBER X2
 344225 NOIR NERO
 344225A CAMEL CAMELLO
 344225B BLANC BIANCO
 344225C GRIS GRIGIO
 344225D ROUGE ROSSO



CLASSIC BANANA X2
 344226 NOIR NERO
 344226A CAMEL CAMELLO
 344226B BLANC BIANCO
 344226C SOFT



CLASSIC BOBBER X2
 344223 NOIR NERO
 344223A CAMEL CAMELLO
 344223B GRIS GRIGIO
 344223C ROUGE ROSSO



CLASSIC BARREL X2
 344224 NOIR NERO
 344224A CAMEL CAMELLO
 344224B BLANC BIANCO

* Adaptable
 * Adattabile

Les références du constructeur sont seulement indicatives et n'impliquent pas que les pièces de rechange viennent du constructeur.
 I codici di riferimento originali sono indicativi e non implicano che i ricambi provengano necessariamente dalla stessa fabbrica del costruttore.

PARTIE CYCLE PARTI CICLISTA

REVETEMENT MANOPOLE

NOEND
Classic
authentic rubber grip



CLASSIC KARATE X2
344227 NOIR NERO
344227A CAMEL CAMELLO



CLASSIC HERO X2
344229 NOIR NERO
344229A CAMEL CAMELLO



CLASSIC CUBE X2
344228 NOIR NERO
344228A CAMEL CAMELLO

REVETEMENT MANOPOLE

TNT
Tuning



GROSS 922X X2
344199 NOIR-ROUGE NERO-ROSSO
344199A NOIR-BLEU NERO-BLU
344199B NOIR-GRIS NERO-GRIGIO
344199C BLANC-BLEU BIANCO-BLU
344199D NOIR-ORANGE NERO-ARANCIONE
344199E NOIR-JAUNE NERO-GIALLO
344199F BLANC-BLEU CIEL BIANCO-BLU



FLAMING X2
344204 NOIR-BLEU NERO-BLU
344204A NOIR-ROUGE NERO-ROSSO
344204B NOIR-GRIS NERO-GRIGIO
344204C NOIR-JAUNE NERO-GIALLO
344204D NOIR-ORANGE NERO-ARANCIONE
344204E NOIR-BLANC NERO-BIANCO



DOME X2
342820 NOIR-CHROME NERO CROMO
342825 NOIR-CARBONE STYLE NERO CARBONIO



MINI TARGA X2
340203 NOIR NERO



KONIK X2
342830 NOIR-CHROME NERO CROMO
342831 NOIR-BLEU NERO BLU
342834 NOIR-ROUGE NERO ROSSO
342835 NOIR-CARBONE STYLE NERO CARBONIO

PARTIE CYCLE PARTI CICLISTA

REVETEMENT MANOPOLE

TNT
Tuning



GOLDEN EAGLE X2
343014 NOIR NERO



ALU GRIP X2
343000 ALU GRIP ALU ALLUMINIO GRIP



BOREAL X2
343054 CHROME CROMO



CUSTOM X2
342704 MOUSSE / FOAM



JOCKEY X2
341001 CHROME-NOIR CHROM-NERO



CHROME-NOIR X2
340610 CHROME-NOIR CROMO-ROSO



TRIBAL X2
340600 CHROME-NOIR CHROM-NERO
340600A CHROME-BLANC CHROM-BIANCO



ULTIMATE X2
342840 NOIR-CHROME NERO-CROMO
342840A NOIR-BLEU NERO-BLU



KUSTOM X2
340600D NOIR NERO
340600E NOIR-ROUGE NERO ROSSO

REVETEMENT MANOPOLE

LEKTRONIS
DEVELOPPEMENT



POIGNEE CHAUFFANTE HEATED GRIP
323301 UNIVERSEL MTO/SCOOTER L.130

PROGRIP



767 X2
344100 NOIR NERO



780 X2
344112 NOIR NERO



730 X2
344112A NOIR NERO

* Adaptable
* Adattabile

Les références du constructeur sont seulement indicatives et n'impliquent pas que les pièces de rechange viennent du constructeur.
I codici di riferimento originali sono indicativi e non implicano che i ricambi provengano necessariamente dalla stessa fabbrica del costruttore.



P

PROGRIP

732



PARTIE CYCLE PARTI CICLISTA

REVETEMENT MANOPOLE

PROGRIP



801		X2
344114	NOIR NERO / JAUNE GIALLO	
344114A	NOIR NERO / ROUGE ROSSO	
344114B	NOIR NERO / BLEU BLU	
344114C	NOIR NERO / ORANGE ARANCIONE	



732		X2
344101	BLEU BLU	
344102	JAUNE GIALLO	
344103	VERT VERDE	
344104	ROUGE ROSSO	
344105	BLANC BIANCO	
344105A	ORANGE ARANCIONE	
344105B	ROSE ROSA	



728		X2
344106	ROUGE ROSSO	
344107	OR ORO	
344108	BLEU BLU	
344108A	SILVER ARGENTO	
344108B	NOIR NERO	



866		X2
344110	ROUGE ROSSO	
344111	BLEU BLU	



794		X2
344113D	BLEU BLU	
344113E	NOIR NERO	
344113F	VERT VERDE	
344113G	ROUGE ROSSO	
344113H	ORANGE ARANCIONE	
344113I	JAUNE GIALLO	



794		X2
344113	FLUO ORANGE ARANCIONE	
344113A	FLUO ROSE ROSA	
344113B	FLUO VERT VERDE	
344113C	FLUOAUNE GIALLO	

* Adaptable
* Adattabile

Les références du constructeur sont seulement indicatives et n'impliquent pas que les pièces de rechange viennent du constructeur.
I codici di riferimento originali sono indicativi e non implicano che i ricambi provengano necessariamente dalla stessa fabbrica del costruttore.

PARTIE CYCLE PARTI CICLISTA

REVETEMENT MANOPOLE



OBSYS 1		X2
344220	BLEU BLU	
344220A	ORANGE ARANCIONE	
344220B	NOIR NERO	
344220C	GRIS GRIGIO	
344220D	BLANC BIANCO	



OBSYS 2		X2
344221	BLEU BLU	
344221A	ORANGE ARANCIONE	
344221B	NOIR NERO	



SMOOTH		X2
344222	NOIR NERO / ROUGE ROSSO	
344222A	NOIR NERO / NOIR NERO	
344222B	BLANC BIANCO / BLEU BLU	
344222C	NOIR NERO / VERT FLUO VERDE	
344222D	NOIR NERO / JAUNE GIALLO	
344222E	NOIR NERO / ROSE ROSA	



732 BI-COMPOSANT BI-COMPONENDO		X2
343910	NOIR-ROUGE NERO-ROSSO	
343910A	NOIR-ORANGE NERO-ARANCIONE	
343910B	BLEU-BLANC BLU-BIANCO	
343910C	GRIS-ORANGE GRIGIO-ARANCIONE	
343910D	NOIR-JAUNE NERO-GIALLO	
343910E	NOIR-GRIS NERO-GRIGIO	
343910F	NOIR-VERT NERO-VERDE	

REVETEMENT DE LEVIER MOUSSE COPRI LEVE SPUGNA



REVETEMENT DE LEVIER COPRI LEVE		X2
330010	NOIR NERO	
330011	ROUGE ROSSO	
330012	BLEU BLU	



REVETEMENT DE LEVIER COPRI LEVE		X2
330000	NOIR-ROUGE NERO-ROSSO	
330001	NOIR-GRIS NERO-GRIGIO	
330002	NOIR-JAUNE NERO-GIALLO	
330004	NOIR-VIOLET NERO-VIOLA	
330005	NOIR-BLEU NERO-BLU	

PARTIE CYCLE PARTI CICLISTA

RETROVISEUR TYPE ORIGINE RETROVISORI ORIGINALE

> SCOOTER



***APRILIA SR 2005**

209023 GAUCHE SINISTRA
209023A DROITE DESTRA



***BOOSTER / BW'S**

208996 GAUCHE SINISTRA



***BOOSTER NEXT**

208992 GAUCHE SINISTRA
208993 DROITE DESTRA



***MBK CARBON STYLE**

208952 DROITE, FILETTAGE GAUCHE
DESTRA, FILETTATURA SINISTRA
208950 GAUCHE SINISTRA



***NITRO / AEROX**

209015 GAUCHE SINISTRA
209016 DROITE DESTRA



***OVETTO / NEOS**

209017 GAUCHE SINISTRA
209018 DROITE DESTRA



***NRG EXTREME**

208986 GAUCHE SINISTRA
208987 DROITE DESTRA



***LUDIX ONE / CLASSIC**

209014A GAUCHE & DROITE SX & DX



***LUDIX ELEGANT / SNAKE**

209014B GAUCHE SINISTRA
209014C DROITE DESTRA



***SPEEDFIGHT**

209013 GAUCHE SINISTRA
209014 DROITE DESTRA



***SPEEDFIGHT 2 VIVACITY**

208982 GAUCHE SINISTRA
208983 DROITE DESTRA



***SQUAB**

209010 GAUCHE SINISTRA
209011 DROITE DESTRA



***STALKER 010**

208987B GAUCHE SINISTRA
208987A DROITE DESTRA



***TREKKER**

208984 GAUCHE SINISTRA
208985 DROITE DESTRA



***PIAGGIO/PEUGEOT CARBON STYLE**

208953 GAUCHE SINISTRA
208954 DROITE DESTRA

* Adaptable
* Adattabile

Les références du constructeur sont seulement indicatives et n'impliquent pas que les pièces de rechange viennent du constructeur.
I codici di riferimento originali sono indicativi e non implicano che i ricambi provengano necessariamente dalla stessa fabbrica del costruttore.

PARTIE CYCLE PARTI CICLISTA

RETROVISEUR TYPE ORIGINE RETROVISORI TIPO ORIGINALE

> SCOOTER



TNT
Original



***PIAGGIO LX 2T 4T / LIBERTY 2T 4T**

208947 GAUCHE SINISTRA
208947A DROITE DESTRA



***PIAGGIO ZIP50**

209020A GAUCHE SINISTRA
209020 DROITE DESTRA



***TYPHOON**

208998 GAUCHE SINISTRA
208999 DROITE DESTRA



***V-CLIC / ROMA / STRADA**

208965 GAUCHE SINISTRA
208965A DROITE DESTRA



***GILERA RUNNER**

209026 GAUCHE SINISTRA
209027 DROITE DESTRA



***CPI ARAGON**

209019A GAUCHE SINISTRA
209019 DROITE DESTRA



***FOX**

209000 GAUCHE SINISTRA
209001 DROITE DESTRA



*** PEUGEOT KISBEE**

208967 GAUCHE SINISTRA
208967A DROITE DESTRA

> 50CC A BOITE 50CC A MARCE



TNT
Original



***APRILIA RS 97-03**

209028 GAUCHE SINISTRA
209029 DROITE DESTRA



***DERBI SENDA**

209024 GAUCHE SINISTRA
209025 DROITE DESTRA SENDA 2000



ENDURO

208946 ENDURO REPLIABLE FOLDING



***MBK XLIMIT / DT 50**

208963 GAUCHE SINISTRA
208963A DROITE DESTRA



***RIEJU**

208957 GAUCHE SINISTRA
208958 DROITE DESTRA



***X-POWER / TZR50 > 2003**

209021 GAUCHE SINISTRA
209021A DROITE DESTRA

PARTIE CYCLE PARTI CICLISTA

RETROVISEUR TYPE ORIGINE RETROVISORI TIPO ORIGINALE

> MAXI SCOOTER *YAMAHA



*TMAX 500 2001-2007

208962 GAUCHE SINISTRA OEM: 5GJ-26280-01
208962A DROITE DESTRA OEM: 5GJ-26290-01



*TMAX 500 2008-2012

208962B GAUCHE SINISTRA OEM: 4B5262801900
208962C DROITE DESTRA OEM: 4B5262901900



*TMAX 530 2012-2014

208962D GAUCHE SINISTRA OEM: 59C-2628-0000
208962E DROITE DESTRA OEM: 59C-2690-0000



*MAJESTY/SKYLINER 125/150/180

208988 GAUCHE SINISTRA OEM: 5DS-F6280-00-00
208989 DROITE DESTRA OEM: 5DS-F6290-00-00



*SKYCRUISER/XMAX 125 2007-2009

209027G GAUCHE SINISTRA OEM: 1B9-F6290-20
209027H DROITE DESTRA OEM: 1B9-F6280-20



*SKYCRUISER/ YAMAHA XMAX 125/250 05-06

209027J GAUCHE SINISTRA OEM: 1B9-F6280-1000
209027I DROITE DESTRA OEM: 1B9-F6290-1000



*TMAX 530 2015-16

208962G GAUCHE SINISTRA OEM: 2PW262800000
208962F DROITE DESTRA OEM: 2PW262900000



*SKYCRUISER / XMAX 125/250 2005-2006

209027L GAUCHE SINISTRA OEM: 1B9F62801000
209027K DROITE DESTRA



*TMAX 530 2012 - 2017

208900 PAIRE D'OBTURATEUR NOIR DE RETROVISEUR RBMAX

> MAXI SCOOTER *HONDA



*HONDA PCX 125

208945B GAUCHE SINISTRA OEM: 88220-KWN-900
208945C DROITE DESTRA OEM: 88210-KWN-900



*HONDA SH 125 / 150 / 300

208945 GAUCHE SINISTRA OEM: 88220-KPR-900
208945A DROITE DESTRA OEM: 88210-KPR-900

> MAXI SCOOTER *VESPA



* VESPA PRIMAVERA 50 / 125

208947H GAUCHE SX OEM: CM182101-CM261901
208947I DROITE DX OEM: CM182102-CM261902



*VESPA ET4

208948 GAUCHE SINISTRA OEM: 581554
208949 DROITE DESTRA OEM: 581555

* Adaptable
* Adattabile

Les références du constructeur sont seulement indicatives et n'impliquent pas que les pièces de rechange viennent du constructeur.
I codici di riferimento originali sono indicativi e non implicano che i ricambi provengano necessariamente dalla stessa fabbrica del costruttore.

PARTIE CYCLE PARTI CICLISTA

RETROVISEUR TYPE ORIGINE RETROVISORI TIPO ORIGINALE

> MAXI SCOOTER *PIAGGIO



*PIAGGIO GT125L / 200L

208961	GAUCHE SINISTRA
OEM: CM073410-073413-CM073407	
208961A	DROITE DESTRA
OEM: CM073411-073414-CM073408	



*PIAGGIO LX 2T 125/150cc & 4T 200cc

208947	GAUCHE SINISTRA OEM: CM020404
208947A	DROITE DESTRA OEM: CM020405



*PIAGGIO BEVERLY 125cc

208947B	GAUCHE SINISTRA OEM: CM025501
208947C	DROITE DESTRA OEM: CM025502



*PIAGGIO X8 125cc

209027C	GAUCHE SINISTRA OEM: CM073902-174802
209027D	DROITE DESTRA OEM: CM073901-174801



*PIAGGIO X9

208955	GAUCHE SINISTRA OEM: 581501
208956	DROITE DESTRA OEM: 581500



*PIAGGIO X10 125CC

208947D	GAUCHE SINISTRA OEM: CM182002
208947E	DROITE DESTRA OEM: CM182003



*PIAGGIO MP3 125/ 300 / 500 YOURBAN

208947F	GAUCHE SINISTRA OEM: CM175019
208947G	DROITE DESTRA OEM: CM175020

> MAXI SCOOTER *KYMCO

> *SYM



*KYMCO DINK 125CC

208966	GAUCHE SINISTRA OEM: 00152957
208966A	DROITE DESTRA OEM: 00152956



*SYM JOYRIDE EVO 125-200

208968	GAUCHE SINISTRA OEM: 88120LVA000
208968A	DROITE DESTRA OEM: 88110LVA000

> MAXI SCOOTER *SUZUKI



*SUZUKI BURGMAN UH 125-200

208969	GAUCHE SINISTRA
208969A	DROITE DESTRA

PARTIE CYCLE PARTI CICLISTA

RETROVISEUR RETROVISORI



M3			
DROIT DESTRA	GAUCHE SINISTRA		Ø8
•209071A	209071	CARBONE STYLE	CARBONIO



RAW			
DROIT DESTRA	GAUCHE SINISTRA		Ø8
•209042	209042A	NOIR MAT	NERO OPACO
•209042B	209042C	ARGENT	ARGENTO



HOLE			
DROIT DESTRA	GAUCHE SINISTRA		Ø8
•209080	•209080A	CHROME	CROMO
•209080D	•209080E	CARBONE STYLE	CARBONIO
•209080F	•209080G	NOIR MAT	NERO OPACO



FLAMMING			
REVERSIBLE REVERSIBILE			Ø8
•209072	CHROME	CROMO	
•209072A	BLEU ANODISE-CHR.	BLU ANODIZ-CROMO	
•209072B	CARBONE STYLE-CHR.	CARBONIO-CROMO	
•209072C	NOIR-CHROME	NERO-CROMO	
•209072D	BLANC-CHROME	BIANCO-CROMO	



MAC 3			
DROIT & GAUCHE DESTRA & SINISTRA			Ø8
•209064	CHROME	CROMO	
•209064C	CARBONE STYLE	CARBONIO	
•209064D	CARBONE MAT	CARBONIO OPACO	



DEMON			
DROIT & GAUCHE DESTRA & SINISTRA			Ø8
•209055	CHROME	CROMO	
•209057	CARBONE STYLE	CARBONIO	



ARTICULÉ			
DROIT & GAUCHE DESTRA & SINISTRA		UNIVERSEL	Ø8
209002	NOIR	NERO	



ELEGANT			
DROIT & GAUCHE DESTRA & SINISTRA			Ø8
•209063E	CARBONE STYLE	CARBONIO	



FLYER			
DROIT & GAUCHE DESTRA & SINISTRA			X2
209065	NOIR	NERO	
209065A	CARBONE STYLE	CARBONIO	



REVERSIBLE			
REVERSIBLE			X1
208991	METAL NOIR	METAL NERO	



UNIVERSEL Ø 108			
REVERSIBLE			X1
208991A	NOIR	NERO	



REVERSIBLE			
REVERSIBLE			X1
209004	NOIR	NERO	



REVERSIBLE			
REVERSIBLE			X1
S621878	METAL NOIR	METAL NERO	



REVERSIBLE			
REVERSIBLE			X1
209004A	NOIR	NERO	

* Adaptable
* Adattabile

Les références du constructeur sont seulement indicatives et n'impliquent pas que les pièces de rechange viennent du constructeur.
I codici di riferimento originali sono indicativi e non implicano che i ricambi provengano necessariamente dalla stessa fabbrica del costruttore.

PARTIE CYCLE PARTI CICLISTA

RETROVISEUR RETROVISORI

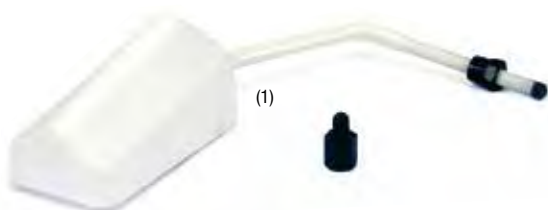

F11 REVERSIBLE REVERSIBLE F11

Ø8	Ø10		
•209030	•209067	CHROME CROMO	
•209034	•209067C	CARBONE STYLE CARBONIO	
•209034A		CARBONE STYLE MAT CARBONIO OPACO	
•209035		ARGENT ARGENTO	
•209035A		BLANC BIANCO	(1)
•209035D	•209067D	NOIR MAT NERO OPACO	



EVO F11 REVERSIBLE REVERSIBLE F11 EVO

•209034B	CARBONE STYLE CARBONIO
•209034C	CARBONE STYLE MAT CARBONIO OPACO
•209035F	BLANC BIANCO
•209035G	NOIR MAT NERO OPACO



F11 "MILLENIUM" F11 "MILLENIUM"

DROIT DESTRA	GAUCHE SINISTRA		
•209045	•209046	CHROME CROMO	
	•209050	CARBONE STYLE CARBONIO	



F11 NEON REVERSIBLE REVERSIBLE NEON F11

•209036	BLEU BLU
•209036A	VERT VERDE
•209036B	JAUNE GIALLO
•209036C	ROSE ROSA
•209036D	ORANGE ARANCIONE



COLLIER ET REDUCTEUR COLLARE E RIDUTTORE



COLLIER SUPPORT POUR RETRO Ø22 COLLARE SUPPORTO RETROVISORE Ø22

M10	M8	PAS 125	THREAD 125
209062A	209062C	PAS A DROITE	DESTRA THREAD
209062B	209062D	PAS A GAUCHE	SINISTRA THREAD



COLLIER SUPPORT POUR RETRO Ø22 COLLARE SUPPORTO RETROVISORE Ø22

209062E



REDUCTEUR RIDUTTORE

209060	M10 / M8	PAS A GAUCHE	PASSO SINISTRO
209061	M10 / M8	PAS A DROITE	PASSO DESTRO
209062	M8 FEM.	PAS GAUCHE / M8 MALE	PAS DROITE DA M8 PASSO SINISTRO A M8 PASSO DESTRO

• ARTICLE NON HOMOLOGUÉ INTERDIT SUR LA VOIE PUBLIQUE

PARTIE CYCLE PARTI CICLISTA

AMORTISSEUR A GAZ AMMORTIZZATORE A GAS

> SCOOTER

CARENZI



***DERBI SENDA 2000**
520540 L.290



***RIEJU / BETA RRT 50**
520541 L.295



***PIAGGIO TYPHOON / STALKER / RUNNER**
520492 L.345



***PEUGEOT BUXY/SPEEDFIGHT SAUF LUDIX**
520493 L.273



***YAMAHA BOOSTER**
520491A L.250



YAMAHA NITRO / AEROX / NEOS 50
520491 L.275



***YAMAHA TZR 50 2004 >**
520542 L.285



***STUNT / SLIDER**
520525

> 50CC A BOITE 50CC A MARCE

CARENZI

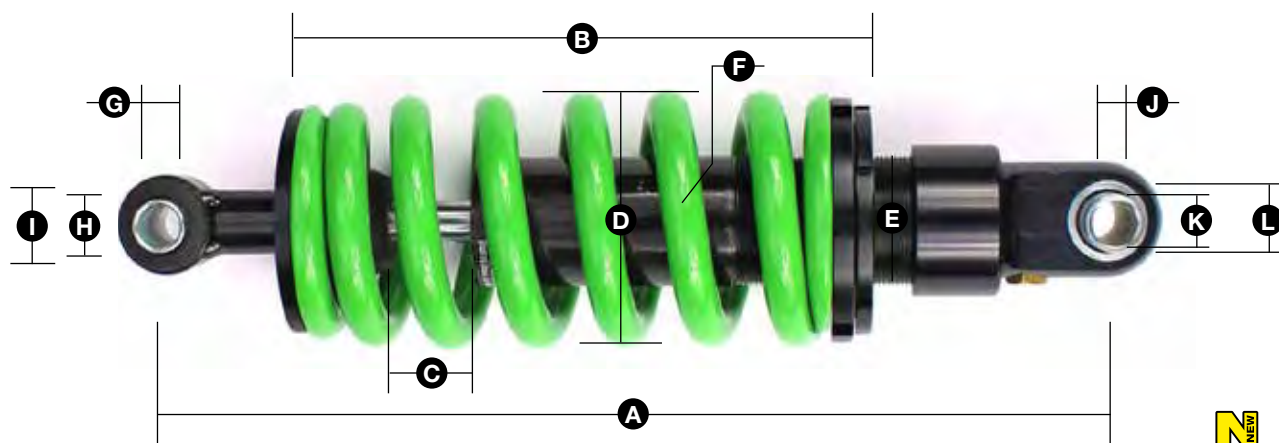

N
NEW

	A	B	C	D	E	F	G	H	I	J	K	L
*DERBI SENDA 2000 520540	290	164	40	70,3	35	11,3	12,1	23	24	12,1	18,2	29,9
*RIEJU / BETA 520541 < 2004	287	1684	50	69,7	35	11,3	10,1	23	26	10	18	25,9
*YAMAHA TZR 50 520542	285	170	55	69	35	11,3	12,1	23	28	10	45	40

- Amortisseur à gaz
- Corps métallique avec traitement anticorrosion
- Piston aluminium Ø32mm
- Recharge du ressort réglable par écrou
- Qualité équivalente à l'origine

- Ammortizzatore a gas
- Corpo metallico con trattamento anticorrosione
- Piston aluminium Ø32mm
- Regolazione precarico molla
- Qualità pari o superiore all'originale

* Adaptable
* Adattabile

Les références du constructeur sont seulement indicatives et n'impliquent pas que les pièces de rechange viennent du constructeur.
I codici di riferimento originali sono indicativi e non implicano che i ricambi provengano necessariamente dalla stessa fabbrica del costruttore.

PARTIE CYCLE PARTI CICLISTA

AMORTISSEUR A GAZ AMMORTIZZATORE DE GAS

> 50CC A BOITE 50CC A MARCE

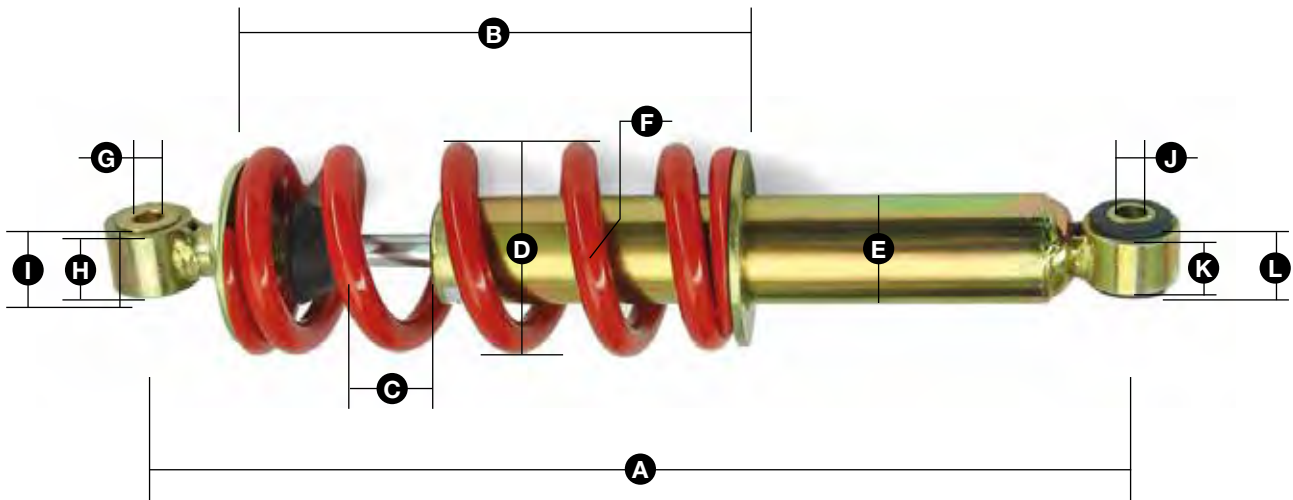

	A	B	C	D	E	F	G	H	I	J	K	L
*APRILIA RS 50 520507 ANCIEN MODELE VECCHIO MOD	275	172	28	69,9	35,2	11,2	10,3	23	35	10,2	30	35
*DERBI SENDA 2000 520500	295	166	40	69,8	35,1	11,4	12,1	23,2	23,9	12,1	18	29,9
*DERBI SENDA 520488	325	137	40	69,6	35	11,3	12,1	23,1	24	12,1	18,2	24,2
*PEUGEOT XP6 520510	295	167	40	69,8	35	11,3	10,1	23	24	10,4	18	24
*RIEJU RR/SM 520516 ANCIEN MODELE VECCHIO MOD	287	164	40	69,7	35	11,3	10,1	23	26	10,1	18	25,9
*SUZUKI RMX/SMX 520520 < 2004	325	165	30	69,7	35	11,3	10	23	31	10	18	31
*DERBI SENDA 520490	335	170	40	69,6	35	11,3	12,1	23	23,9	12,1	18	24
*DERBI SENDA 2000 520501	280	164	40	70,3	35	11,3	12,1	23	24	12,1	18,2	29,9
*DERBI SENDA GPR 520505	260	174	28	70	35,2	11,3	10,1	23	35	12,1	18	24
*RIEJU RS1 520517	255	168	35	69,9	35	11,4	10,1	18	26	10,1	18	26
*YAMAHA TZR 50 520513 < 2004	255	168	55	69	35,15	11,3	12,1	23	35	12,15	45	49,85
*YAMAHA TZR 50 520513A > 2004	285	170	55	69	35	11,3	12,1	23	28	10	45	40
*BETA RRT 50 520515	295	165	30	39	35	11,3	10,1	23	24	10	15	30

- Amortisseur à gaz
- Corps métallique avec traitement anticorrosion
- Piston aluminium Ø32mm
- Recharge du ressort réglable par écrou
- Qualité équivalente à l'origine

- Ammortizzatore a gas
- Corpo metallico con trattamento anticorrosione
- Piston aluminium Ø32mm
- Regolazione precarico molla
- Qualità pari o superiore all'originale

>



***CITY 1&2**
970901 L.330

PARTIE CYCLE PARTI CICLISTA

AMORTISSEUR HYDRAULIQUE AMMORTIZZATORE IDRAULICO

> SCOOTER

TNT
Original



***BOOSTER / BW'S**
520460 L.250 LUXE LUXURY



***BUXY / TREKKER / SPEEDFIGHT**
520461 L.290 LUXE LUXURY



***PEUGEOT SPEEDFIGHT / TREKKER**
520463 L.270 LUXE LUXURY



***OVETTO/NEOS**
520464 L.280 LUXE LUXURY



***NITRO / AEROX / CPI**
520465 L.270 LUXE LUXURY



***PEUGEOT SPEEDFIGHT AV**
520468 L.270 LUXE LUXURY

> MAXI SCOOTER

TNT
Original



***MAJESTY / SKYLINER** X2
520527

> CYCLO CICLOMOTORE

TNT
Original



REGLABLE REGOLABILE
S360 CYCLO

* Adaptable
* Adattabile

Les références du constructeur sont seulement indicatives et n'impliquent pas que les pièces de rechange viennent du constructeur.
I codici di riferimento originali sono indicativi e non implicano che i ricambi provengano necessariamente dalla stessa fabbrica del costruttore.

PARTIE CYCLE PARTI CICLISTA

REHAUSSE AMORTISSEUR RIALZO AMMORTIZZATORE



*MINARELLI HORIZONTAL

520600	CHROME CROMO
520602	BLEU BLU
520605	NOIR MAT NERO OPACO
520606	ROUGE ROSSO
520608	CARBONE STYLE CARBONIO
520608B	BLANC BIANCO



*BOOSTER 2004 / NITRO / AEROX

520623	CHROME CROMO
520623A	BLEU BLU
520623B	ROUGE ROSSO
520623C	CARBONE STYLE CARBONIO
520623D	BLANC BIANCO
520623E	NOIR MAT NERO OPACO



*MINARELLI VERTICAL < 2004

520621	CHROME CROMO
520621A	BLEU BLU
520621D	BLANC BIANCO
520621E	NOIR MAT NERO OPACO



*TYPHOON

520615	BLEU BLU
520616	CHROME CROMO
520617	BLANC BIANCO
520618	NOIR MAT NERO OPACO
520620	CARBONE STYLE CARBONIO



*TREKKER / SPEEDFIGHT

520622A	BLEU BLU
520622B	ROUGE ROSSO
520622C	CARBONE STYLE CARBONIO
520622D	BLANC BIANCO
520622E	NOIR MAT NERO OPACO



*PEUGEOT LUDIX

520624	CHROME CROMO
520624A	BLEU BLU
520624C	CARBONE STYLE CARBONIO
520624D	BLANC BIANCO

TENDEUR DE ROUE TENDICATENA



TENDEUR DE ROUE TENDICATENA

170700	CYCLO CICLOMOTORE
--------	-------------------

ROULEMENT DE ROUE CUSCINETTO RUOTA



ROULEMENT DE ROUE CUSCINETTO RUOTA

SCOOTER SCOOTER

100610	6201 1RS	*TYPHOON	ARRIERE POSTERIORE
100660	6300 1RS	*BOOSTER / BW'S	
100661	6203 2RS	*BOOSTER / BW'S	ARRIERE POST
100700	6202	*BUXY	AVANT / ARR. ANT / POST
100860	6004	*BUXY	ARRIERE POST

S116202 6202 2RS

S536002 6002 2RS

S536003 6003 2RS FAG

CYCLO CICLOMOTORE

100600	6001 2RS	*PEUGEOT 103 / MBK 51	ARR. POST
100610	6201 1RS	*PEUGEOT 103 / MBK 51	ARR. POST
100650	6200 1RS	*PEUGEOT 103 / MBK 51	AV. ANT

PARTIE CYCLE PARTI CICLISTA

FOURCHE CYCLO FORCELLA CICLOMOTORE



***PIAGGIO CIAO**
290002



***PIAGGIO CIAO**
290005 TELESCOPIQUE (2)



***PEUGEOT**
290050 *103 MVL



***PEUGEOT 103 FOX**
290055



***103 SP / MBK 51**
290055A AVEC STABILISATEUR
RENFORCE + REGLAGE
PRECHARGE RESSORT



***103 SP3/SPX / MBK MAGNUM**
290070



***103 SP / MBK 51**
290080



***103 SP / MBK 51**
290085 ALU HRIDRAULIQUE



***103 SP 028**
290100

JOINTS SPY PARAOLIO



JOINT SPY + CACHE POUSSIERE FOURCHE EBR

290178 *BOOSTER / BW'S / NITRO / AEROX
290179 *PEUGEOT / PIAGGIO

JOINT SPY DE FOURCHE PARAOLIO

SCOOTER				
290177	*BOOSTER / NEOS / F10 / CW50	26	37	10,5 TC4
290177A	*RS 50 / PLY 50 4T / LIBERTY 50 4T / BURGMAN 125	30	40	8/9 TC4L
290177B	*BOOSTER 50R / GUGNUS 125X / AN 125	30	40,5	10,5 TC4
290177C	*NITRO 50	30	42	10,5 TC4
290177D	*F12 PHANTOM / TREKKER 50 / LIBERTY 125	31,7	42	7/9 TCL
290177G	*RUNNER / STALKER / TYPHOON / BUXY	26	35,5/37,7	6 TC4L
50CC A BOITE 50CC A MARCE				
290177E	*DERBI SENDA 50R / GPR 50R / XR6 E50	35	48	11 TC4
290177F	*DERBI SENDA R EXTREME / SENDA DRD	36	48	11/12,5 TC4L
290177H	*DERBI SENDA FOURCHE MARZOCCHI	40	52	10/10,5 TC4L
040980	*DERBI SENDA	31	43	10,5

* Adaptable
* Adattabile

Les références du constructeur sont seulement indicatives et n'impliquent pas que les pièces de rechange viennent du constructeur.
I codici di riferimento originali sono indicativi e non implicano che i ricambi provengano necessariamente dalla stessa fabbrica del costruttore.

PARTIE CYCLE PARTI CICLISTA

FOURCHE SCOOTER FORCELLA SCOOTER

TNT
Original

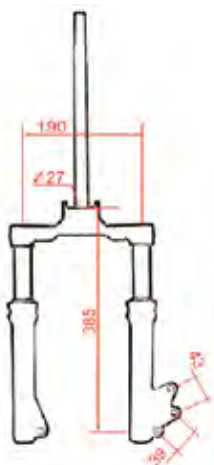

***BOOSTER SPIRIT 99 > 03**
290127

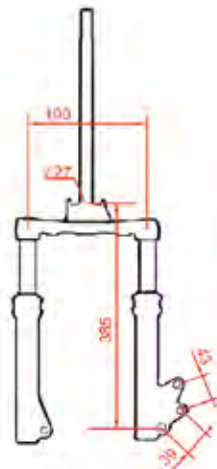

***BOOSTER SPIRIT > 04**
290129

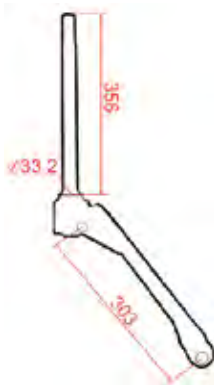

***SPEEDFIGHT 2**
290150

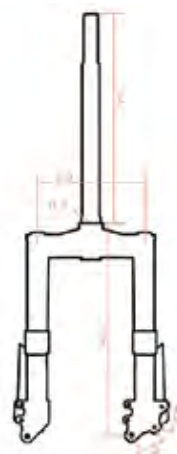

***TYPHOON**
290151

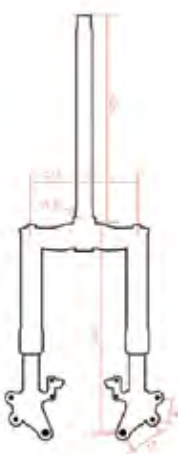

***RUNNER 2004/2005**
290152

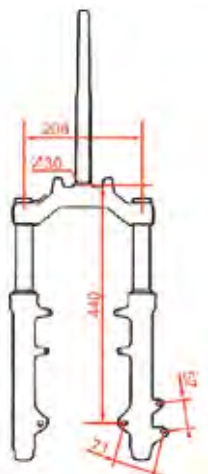

***STUNT**
290155

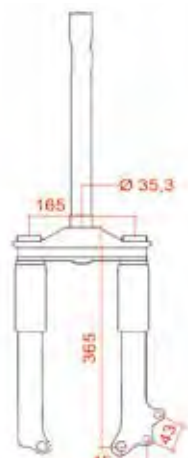

***ZIP 50 2T/4T**
290153

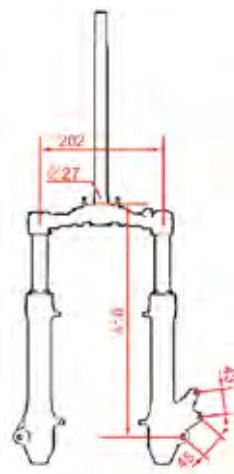

***NITRO < 03 / NEXT / ROCK**
290157

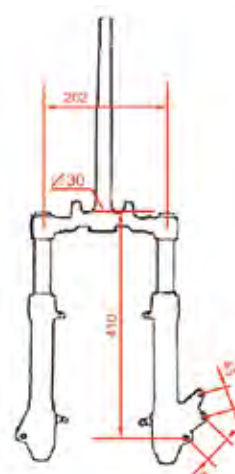

***NITRO > 03**
290158

EBR

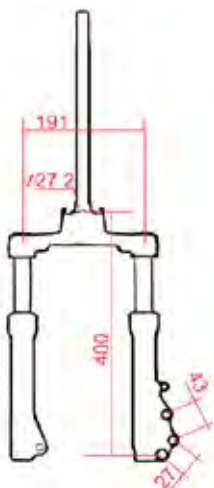

***BOOSTER ROAD < 99**
290125

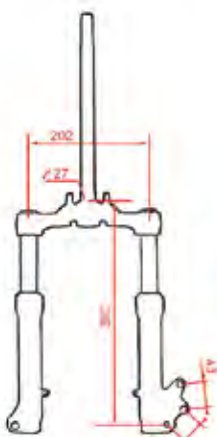

***BOOSTER ROCKET**
290126

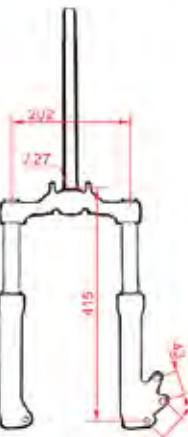

***BOOSTER NEXT 99**
290128

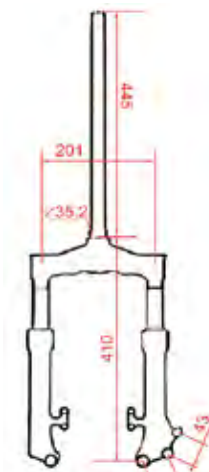

***TYPHOON/MC2/NTT**
290138

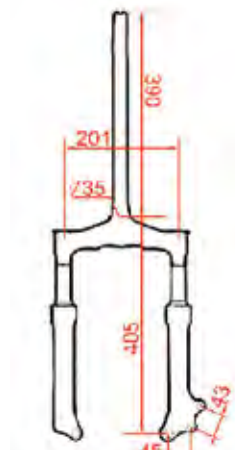

***STALKER**
290140

PARTIE CYCLE PARTI CICLISTA

FOURCHE SCOOTER FORCELLA SCOOTER

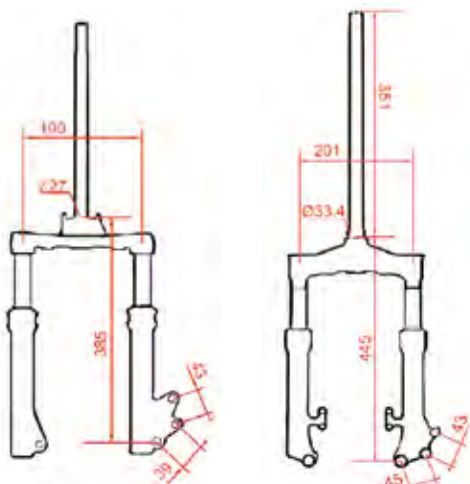

***BOOSTER 2004 / BWS 2004**
290131
290055B REGLABLE AJUSTABLE

***TREKKER Ø32**
290130

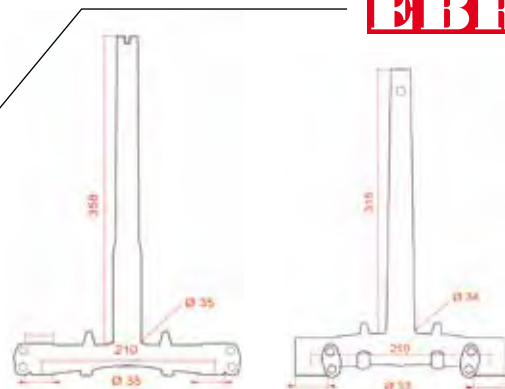

***HONDA SH 300**
290181B

***HONDA SH 125/150**
290181C

TE DE FOURCHE PIASTRA FORCELLA

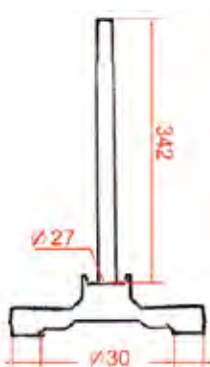

***BOOSTER SPIRIT 99 > Ø3**
290180 Ø30

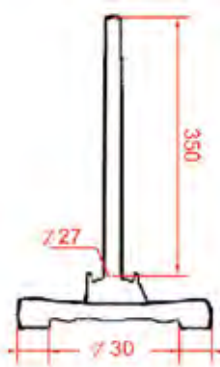

***BOOSTER SPIRIT 2004**
290181A

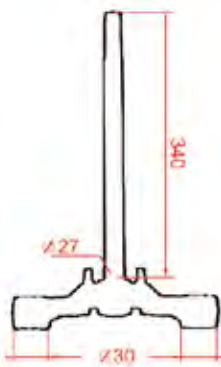

***BOOSTER NEXT / NITRO <Ø3**
290182 Ø30

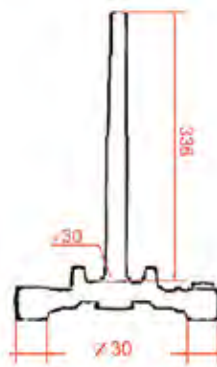

***NITRO / AEROX > Ø3**
290182A



***OVETTO / NEOS Ø26**
290183

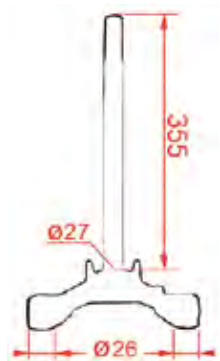

***MACH-G**
290184

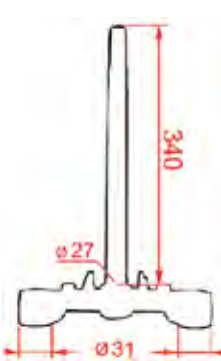

***SCOOTER CPI**
290185

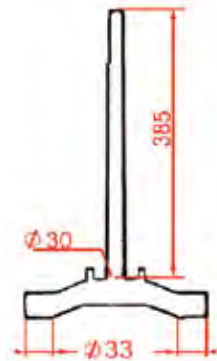

***STUNT / SLIDER**
290191 Ø30

* Adaptable
* Adattabile

Les références du constructeur sont seulement indicatives et n'impliquent pas que les pièces de rechange viennent du constructeur.
I codici di riferimento originali sono indicativi e non implicano che i ricambi provengano necessariamente dalla stessa fabbrica del costruttore.

PARTIE CYCLE PARTI CICLISTA

JEU DE DIRECTION CUSCINETTI DI STERZO

> SCOOTER

TNT
Original



***BUXY / ZENITH
SPEEDAKE**

290217



***VIVACITY / TREKKER
SPEEDFIGHT / LUDIX**

290225



***BOOSTER ROAD
BOOSTER 2004 / MACH-G**

290215



***NITRO <2003 / NEXT
OVETTO / SPIRIT**

290216



***STUNT / NITRO > 2003**

290220



***PEUGEOT KISBEE 50**

290217A



***SCARABEO 50**

290221



***SCOOTER PIAGGIO**

290218



***SCOOTER CPI 50CC**

290219



***MALAGUTTI F12/F15**

290221A



***CIAO**

S3943



***PEUGEOT V-CLIC 50cc**

290217B



***KYMCO 50 / 125 / SYM 50 /
125 / HONDA LEAD 110**

290219A

> MAXI SCOOTER

TNT
Original



***HONDA SH 125/150-DYLAN-
CHIOCCIOLA**

290230



***HONDA SH 300**

290230A



***YAMAHA XMAX 125/150
06-90**

290231



***YAMAHA XMAX 125/150
<2010**

290231A



***YAMAHA TMAX 500
2001-2007**

290231B



***YAMAHA TMAX 500 / 530
2008-2016**

290231C

> JANTE CERCHIO

CARENZI



**ADAPTATEUR JANTE NITRO AR BOOSTER / STUNT
ADATTATORE PER CERCHIO NITRO POST BOOSTER**

253000

PARTIE CYCLE PARTI CICLISTA
BEQUILLE LATERALE CAVALLETTO LATERALE

➤ **SCOOTER**

bwz-zet®



***PEUGEOT FOX**
370821A



***SQUAB / TREKKER**
370820



***SPEEDFIGHT**
370821



***LUDIX**
370822A *LUDIX 10"



***ST 50**
S114641



***SV 50**
S114645



***NITRO / AEROX**
370810



***STUNT / SLIDE**
370812



***BOOSTER 2004**
370805A



***OVETTO / NEOS 2007**
370811A



***LIBERTY 50 2/4T MOD RST**
370821C



***MACH G 50**
370853A



***TYPHOON ZIP 50 SP 2T**
370821E



***PIAGGIO NRG POWER 50**
370821B



***APRILIA SR**
370800A

➤ **MAXI SCOOTER**

bwz-zet®



***LIBERTY 125**
370836A



***SH 125 / 150 4T**
370836B

* Adaptable
* Adattabile

Les références du constructeur sont seulement indicatives et n'impliquent pas que les pièces de rechange viennent du constructeur.
 I codici di riferimento originali sono indicativi e non implicano che i ricambi provengano necessariamente dalla stessa fabbrica del costruttore.

PARTIE CYCLE PARTI CICLISTA

BEQUILLE LATÉRALE CAVALLETTO LATÉRALE

> SCOOTER

TNT
Original



***BOOSTER / BW'S**
370660 CHROME CROMO



***BOOSTER NEXT**
370660D CHROME CROMO



***NITRO / AEROX**
370660A CHROME CROMO



***LUDIX**
370822C



***STUNT / SLIDER**
370660B CHROME CROMO



***SPEEDFIGHT**
370660C CHROME CROMO



***OVETTO / NEOS 2007**
370811



***STALKER / NRG / MC2**
370660E CHROME CROMO



***TREKKER / SQUAB**
370660F CHROME CROMO



***PIAGGIO ZIP 2/4T 50**
370660G



***NRG EXTREME H20**
370835 RUNNER >2001



***NTT / SFERA / TYPHOON**
370831

TNT
Tuning



***BOOSTER / BW'S**
370521 ARGENT ARGENTO
370522A NOIR MAT NERO OPACO
370523 CARBONE STYLE CARBONIO



***NITRO / AEROX**
370510 BLEU ANODISE BLU ANODIZZATO
370511 ARGENT ARGENTO
370512A NOIR MAT NERO OPACO
370513 CARBONE STYLE CARBONIO



***STUNT / SLIDER**
370525 ARGENT ARGENTO
370525A NOIR MAT NERO OPACO

> CYCLO CICLOMOTORE

TNT
Tuning



STANDARD
372000 L. 270 MM LISSE ROPE



***CIAO**
370812A



***PEUGEOT 103 / MBK 51 REVERSIBLE**
373510 BRAS CARRÉ QUADRO

PARTIE CYCLE PARTI CICLISTA
BEQUILLE CENTRALE CAVALLETTO CENTRALE

> SCOOTER - MAXI SCOOTER

bwzeta®



***APRILIA SR**
370870



***OVETTO / NEOS**
370853



***BOOSTER 2004**
370850A



***PIAGGIO ET2 50 / ZIP 50**
370877A



***LUDIX 10"**
370872A



***LUDIX 14"**
370872B



***STUNT / SLIDER**
370871



***OVETTO / NEOS 4T 2013**
370811B



***PIAGGIO ET4**
370877



***LEONARDO 125**
370878



***LIBERTY 125**
370876

> SCOOTER - MAXI SCOOTER

TNT®
Original



***BOOSTER / BW'S**
370900



***NITRO / AEROX**
370900A



***STUNT / SLIDER**
370900B



***OVETTO / NEOS**
370900C



***NRG / STALKER**
370866



***HONDA SH 125 / 150**
370879A



TAMPON BUTOIR RUBBER STOP
373950 X20

* Adaptable
* Adattabile

Les références du constructeur sont seulement indicatives et n'impliquent pas que les pièces de rechange viennent du constructeur.
I codici di riferimento originali sono indicativi e non implicano che i ricambi provengano necessariamente dalla stessa fabbrica del costruttore.

PARTIE CYCLE PARTI CICLISTA
REPOSE-PIEDS PEDALINE

> **CYCLO CICLOMOTORE**



PEDALE CIRETTE
 360075 *103 / MBK 51



PEDALE CIRETTE
 360076 *103 MVL

> **5OCC A BOITE 5OCC A MARCE**



***APRILIA RS 99 ARRIERE POSTER.**
 360020 ARGENT ARGENTO
 360021 BLEU BLU



***APRILIA RS 99 AVANT ANTERIORE**
 360015 ARGENT ARGENTO



***XPOWER/TZR AVANT ANTERIORE**
 360000 ARGENT ARGENTO



***SENDA**
 360010 ARGENT ARGENTO
 360011 BLEU BLU
 360012 ROUGE ROSSO



UNIVERSAL ARRIERE POSTER.
 360035 ARGENT ARGENTO
 360035A NOIR NERO
 360036 BLEU BLU
 360037 ROUGE ROSSO

> **UNIVERSEL UNIVERSALE**



CYCLO CICLOMOTORE
 363005 ARGENT ARGENTO



ROND TONDE
 362313 NOIR NERO



ARRIERE POSTERIORE
 360035A NOIR NERO



REPLIABLE RIPIEGABILI
 362203 NOIR NERO



PEDALE PEDALI
 360303 NOIR NERO



***XLIMIT 04**
SABOT MOTEUR ALU
PROTEZIONE MOTORE ALLUMINIO
 376001 ARGENT ARGENTO
 376001C CARBONE STYLE CARBONIO

PARTIE CYCLE PARTI CICLISTA

GARDE BOUE MUDGUARD



GARDE BOUE AVANT UNIVERSEL
PARAFANGO ANTERIORE UNIVERSALE

380350	BLANC BIANCO
380351	NOIR NERO
380352	ROUGE ROSSO
380353	BLEU BLU
380354	ORANGE ARANCIONE



F11
GARDE BOUE AVANT PARAFANGO ANTERIORE

380200	BLANC BIANCO
380203	NOIR NERO
380205	CHROME CROMO



GARDE BOUE AVANT UNIVERSEL
PARAFANGO ANTERIORE UNIVERSALE

380360	NOIR/NOIR NERO/NERO
380360A	NOIR/BLANC NERO/BIANCO
380360B	NOIR/ROUGE NERO/ROSSO
380360C	NOIR/BLEU NERO/BLU
380360D	NOIR/ORANGE NERO/ARANCIONE



GRILLE DECORATIVE GRIGLIE DECORATIVE



GRILLE GRIGLIE 30CM X 30CM

093580	BLEU BLU
093581	SILVER ARGENTO
093582	NOIR NERO
093585	OR ORO

IMMATRICULATION PORTATARGA



***SPEEDFIGHT / TREKKER**
SUPPORT LATERAL SUPPORTO LATERALE TARGA

541252	METAL FROID METAL FREDDO
541252B	NOIR MAT NERO OPACO



***TYPHOON / LUDIX**
SUPPORT LATERAL SUPPORTO LATERALE TARGA

541251	METAL FROID METAL FREDDO
541251A	BLEU ANODISE BLU ANODIZZATO
541251B	NOIR MAT NERO OPACO



***BOOSTER / NITRO / OVETTO / STUNT**
SUPPORT LATERAL SUPPORTO LATERALE TARGA

541250	METAL FROID METAL FREDDO
541250A	BLEU ANODISE BLU ANODIZZATO
541250B	NOIR MAT NERO OPACO
541250C	BLANC BIANCO



SUPPORT PLAQUE IMMATRICULATION
PORTATARGA MTO / MAXISCOOTER

541253	NOIR NERO
--------	-----------



SUPPORT VIGNETTE ASSURANCE
SUPPORTO TAGLIANDINO ASSICURAZIONE

541400	ALU ALLUMINIO
--------	---------------

* Adaptable
 * Adattabile

Les références du constructeur sont seulement indicatives et n'impliquent pas que les pièces de rechange viennent du constructeur.
 I codici di riferimento originali sono indicativi e non implicano che i ricambi provengano necessariamente dalla stessa fabbrica del costruttore.

PARTIE CYCLE PARTI CICLISTA

SELLE SELLA

> COUVRE SELLE SCOOTER COPERTINA SELLA SCOOTER

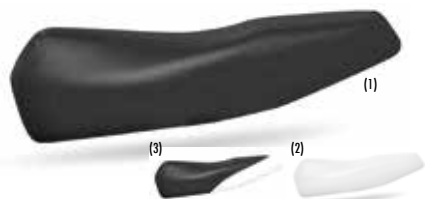

*BOOSTER SPIRIT

580230	NOIR NERO	(1)
580231	BLANC BIANCO	(2)
580236A	NOIR / BLANC NERO / BIANCO	(3)

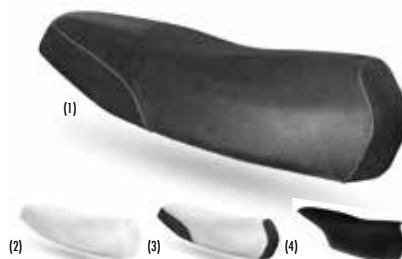

*BOOSTER 2004

580122	NOIR NERO	(1)
580122A	BLANC BIANCO	(2)
580122B	BLANC / NOIR BIANCO / NERO	(3)
580122D	NOIR / BLANC NERO / BIANCO	(4)



*NITRO

580272	BLANC / NOIR BIANCO / NERO	(1)
580272A	NOIR / BLANC NERO / BIANCO	(2)



*SPEEDFIGHT

580262	NOIR / BLANC / CARBONE NERO / BIANCO / CARBON
--------	---



*OVETTO / NEOS

580245	BLANC BIANCO
580246	NOIR NERO

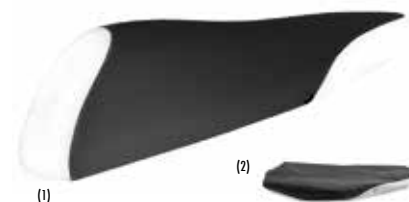

*STUNT

580276	BLANC / NOIR BIANCO / NERO	(2)
580276C	NOIR NERO	
580276E	NOIR / BLANC NERO / BIANCO	(1)



*MACH G / JOG R

580320	NOIR NERO
--------	-----------

*PIAGGIO ET2/4 50-125-150

580316	NOIR NERO
--------	-----------

*VESPA LX 50 - 125 - 150

580317	NOIR NERO
--------	-----------

*ZIP 4T

580319	NOIR NERO
--------	-----------

> MAXI SCOOTER



COUVRE SELLE COPERTINA SELLA

580314	*X-MAX 125
580314A	*X-MAX 125 2010 > 2014 tous modèles sauf sport
580315	*T-MAX 500 2004
580315A	*T-MAX 530 2012
580316	*PIAGGIO ET2/4 50-125-150
580317	*VESPA LX 50-125-150
580277	*HONDA SH 125-150 2002 > 2007
580277D	*HONDA SH 125-150 I
580277A	*HONDA SH 300



*YAMAHA TMAX 500 / 530CC 2008-17 (x2)

580315B	Entraxe de fixation : 152.5 mm
	OEM: 4B52478G0000

*YAMAHA XMAX 125 2006-10 (x1)

580315C	OEM : 1B9F478G3000
---------	--------------------

> 50CC A BOITE 50CC A MARCE



*SENDA NM

580310	NOIR NERO
580311	GRIS / NOIR GRIGIO / NERO
580312	ROUGE / NOIR ROSSO / NERO

*SENDA AM

580302	NOIR NERO
--------	-----------

> SELLE COMPLETE SELLA COMPLETA



***TYPHOON**

580105 NOIR NERO

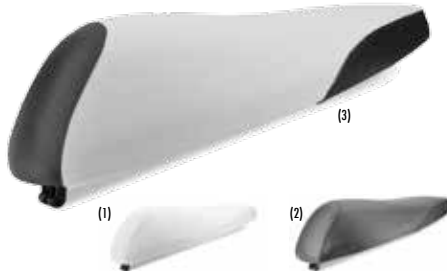

***STUNT / SLIDER**

580121 BLANC BIANCO (1)
580121A NOIR NERO (2)
580121B NOIR / BLANC NERO / BIANCO (3)



***NEXT**

NOIR / CARBONE NERO / CARBONIO
580200 < 99
580210 > 99



***BOOSTER SPIRIT**

580095 BLEU / BLANC BLU / BIANCO (1)
580096 BLANC / NOIR BIANCO / NERO (2)
580099 BLANC BIANCO (3)
580100 NOIR NERO (4)

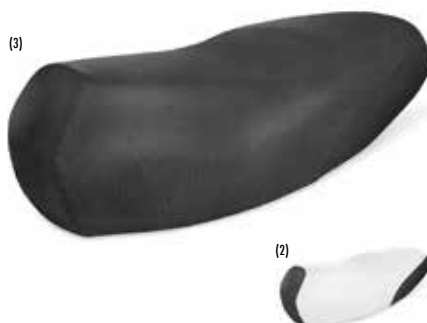

***BOOSTER 2004**

580096A NOIR / BLANC NERO / BIANCO (1)
580100A NOIR NERO (2)



***NITRO / AEROX**

580120 BLANC BIANCO (1)
580120A NOIR NERO (2)
580120B NOIR / BLANC NERO / BIANCO (3)



***PIAGGIO ZIP 2T H2O**

580318 NOIR NERO
580318A NOIR / ROUGE NERO / ROSSO ANTIDERAPANT



***PIAGGIO LIBERTY 50/125**

580277C NOIR NERO (ELASTIQUE ELASTICO)



***APRILIA SCARABEO 50**

580277B NOIR NERO (ELASTIQUE ELASTICO)

> HOUSE TELO COPRI MOTO



- 100% étanche
- Protection contre la pluie, le soleil et la neige, de -25°C à 50°C
- Protection anti-rayures
- Sangles d'attache contre le vent

- 100% stagno
- Protezione contro la pioggia, il sole e la neve, de -25°C à 50°C
- Protection anti-rayure
- Sangles d'attache contre le vent

**HOUSSE DE PROTECTION MOTO / SCOOTER
TELO COPRI MOTO / SCOOTER**

507100B TAILLE L 232 X 100 X 125 CM
507100C TAILLE XL 246 X 105 X 127 CM
507100D TAILLE XXL 264 X 105 X 130 CM

* Adaptable
* Adattabile

Les références du constructeur sont seulement indicatives et n'impliquent pas que les pièces de rechange viennent du constructeur.
I codici di riferimento originali sono indicativi e non implicano che i ricambi provengano necessariamente dalla stessa fabbrica del costruttore.

> T



COOCASE
ALUMINIUM SERIES



X1 ALUMINIUM SERIES
40 LITRES



X3 ALUMINIUM SERIES
60 LITRES

PARTIE CYCLE PARTI CICLISTA
TOP CASE BAULETTO

➤ **X1 & X3 ALUMINIUM SERIES**

COOCASE



N	X1 ALUMINIUM SERIES
	40 L - L 343 x l 422 x H 306 mm
	Fermeture à clé - Etanche
	Livré avec platine
	Chiusura a chiave - A tenuta stagna
	Consegnato con fissazione
	549070 NOIR NERO
	549070B GRIS GRIGIO



N	X3 ALUMINIUM SERIES
	60 L - L 395 x l 565 x H 308 mm
	Fermeture à clé - Etanche
	Livré avec platine
	Chiusura a chiave - A tenuta stagna
	Consegnato con fissazione
	549070A NOIR NERO
	549070C GRIS GRIGIO

➤ **SUPPORT DE TOP CASE X1 ET X3 (support haut)**
SUPPORTO BAULETTO X1 E X3 (supporto alto)

COOCASE



***HONDA AFRICA TWIN 1000 2017**
549063A

N

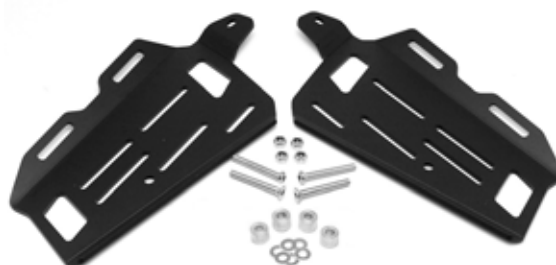

***BMW R1200GS**
549063

N



***YAMAHA TRACER MT09**
549063B

N



***HONDA XADV 2017**
549063C

N

* Adaptable
 * Adattabile

Les références du constructeur sont seulement indicatives et n'impliquent pas que les pièces de rechange viennent du constructeur.
 I codici di riferimento originali sono indicativi e non implicano che i ricambi provengano necessariamente dalla stessa fabbrica del costruttore.



 **COOCASE**





ASTRA LUXURY

549049 **48 L** - L 576 x l 440 x H 313 mm
 Fermeture à clé et télécommande. Alarme.
 Feux stop à led. Etanche
 Chiusura a chiave e telecomando. Allarme
 Faro stop a led. A tenuta stagna



WIZARD

549047 **36 L** - L 450 x l 412 x H 310 mm
 Fermeture à clé. Etanche
 Chiusura a chiave. A tenuta stagna

WIZARD LUXURY

549048 **36 L** - L 450 x l 412 x H 310 mm
 • Idem modèle de base
 + Fermeture à clé et télécommande. Alarme.
 Feux stop à led
 • Idem modelo base
 + Chiusura a chiave e telecomando
 Allarme. Faro stop a led



ASTRA S48

549061 **48 L** - L 576 x l 440 x H 313 mm
 Fermeture à clé. Etanche
 Chiusura a chiave. A tenuta stagna



S30B

549051 **30 L - PAR 10**
 Fermeture à clé. Etanche
 Chiusura a chiave. A tenuta stagna



S30S.B

549052 **30 L**
 Fermeture à clé. Etanche
 Chiusura a chiave. A tenuta stagna

PARTIE CYCLE PARTI CICLISTA
SUPPORT DE TOP CASE SUPPORTO BAULETTO

> *PIAGGIO

COOCASE



N
NEW

KYMGCO XCITING 400 2012
549062R



N
NEW

PIAGGIO LIBERTY 50 / 125 / 200CC 2000-08
549062Q



***PIAGGIO ZIP 50/125 2000-2007**
549062G



***PIAGGIO BEVERLY 125 / 250 2001-2007 /
BEVERLY 500 2003-2007**
549062H



***PIAGGIO FLY 50/125 2004-2008**
549062C



***PIAGGIO VESPA LX 50/125 2005-2008**
549062B

> *YAMAHA

COOCASE



***YAMAHA MAJESTY 125 / 150 2001-20118**
549062K



***YAMAHA TMAX 500 2008-2011**
549062E



***YAMAHA TMAX 530 2012**
549062F



***YAMAHA MAJESTY 400 2004-2008**
549062J



N
NEW

YAMAHA MAJESTY / XMAX 250 2009
549062M

PARTIE CYCLE PARTI CICLISTA
SUPPORT DE TOP CASE SUPPORTO BAULETTO

> *KYMCO

COOCASE



N
NEW

KYMCO DOWNTOWN 125 / 300CC 2009-011
549062N



N
NEW

KYMCO K-XCT 300CC 2013
549062O



N
NEW

KYMCO NEW DOWN TOWN 2015
549062P

> *SUZUKI

COOCASE



***SUZUKI BURGMAN 125/200 2007-2011**
549062A



***SUZUKI BURGMAN 650 2002-2011 / K4-K3-K5**
549062I

> *HONDA

> *SYM

COOCASE



***HONDA PCX 125/150**
549062



N
NEW

SYM JOYRIDE 125 / 150-200CC 2001-08
549062D



**ADAPTATEUR TOP CASE COOCASE POUR
SUPPORT GIVI ET KAPPA**
SUPPORT GIVI E KAPPA
549046G

* Adaptable
* Adattabile

Les références du constructeur sont seulement indicatives et n'impliquent pas que les pièces de rechange viennent du constructeur.
I codici di riferimento originali sono indicativi e non implicano che i ricambi provengano necessariamente dalla stessa fabbrica del costruttore.

PARTIE CYCLE PARTI CICLISTA

TOP CASE BAULETTO

COOCASE



PRESENTOIR DISPLAY
549060



KIT SERRURE KIT SERRATURE
549046B VIVO 28L / 30L
549047B WIZARD 36L
549049D ASTRA 48L



**MOTEUR DE SERRURE
MOTORE SERRATURE**
549047C WIZARD LUXURY 36L



STOP LED ASTRA 48 L
549049B GAUCHE SINISTRA
549049C DROIT DESTRA



STOP LED WIZARD 36 L
549048A GAUCHE SINISTRA
549048B DROIT DESTRA



KIT SANGLES FISSAGGIO
549046A VIVO 28L



KIT SANGLES FISSAGGIO
549047A WIZARD 36L
549049A ASTRA 48L



DOSSERET POGGIASCHIENA
549049E GRAND FORMAT GRANDE MODEL
549046C PETIT FORMAT PICCOLO MODEL

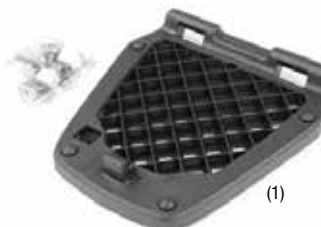

PLATINE SUPPORTO
549046F ASTRA 48L
549046D VIVO 28L / 36L
549046E VIVO LUXURY 28L / 36L

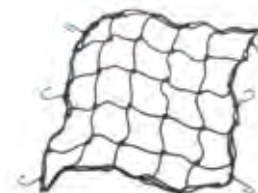

**FILET BAGAGES AVEC CROCHETS
RETE RAGNO CON GANCI**
500120A 30 X 30 CM
500120B 40 X 40 CM

TABLIER COPRIGAMBE

TNT
Original



**TABLIER UNIV. SCOOTER /MAXI SCOOTER
COPRIGAMBE UNIVERSALE**
503359A

- Universel
- Interieur matelassé
- 2 grandes poches
- Fixation à la taille réglable

- Universale
- Interno trapuntato
- 2 ampie tasche
- Attacco regolabile in vita



**TABLIER UNIV. SCOOTER /MAXI SCOOTER
COPRIGAMBE UNIVERSALE**
503359B

PARTIE CYCLE PARTI CICLISTA

PARE BRISE PARABREZZA

FACO



***PIAGGIO MP3**
405002



***VESPA LX**
405002A KIT MONTAGE PEINT



***VESPA PRIMAVERA 2014**
405002B KIT MONTAGE CHROME



***VESPA SPRINT 2014**
405002C KIT MONTAGE CHROME



***YAMAHA TMAX 500 2001-2007**
405001



***YAMAHA TMAX 530**
405001B



***YAMAHA XMAX 125-250 < 2009**
405001C



***YAM XMAX 125-250 2014 / XMAX 400 2013**
405001D



***YAMAHA TMAX 500 2008-2011**
405001A



***HONDA FORZA 125**
405003

> KIT VISSERIE BULLE SET VITERIA CUPOLINI

TNT
Original



KIT VISSERIE BULLE DE MOTO (8 PCS)
SET VITERIA CUPOLINI
171005 NOIR NERO
171005A SILVER

* Adaptable
* Adattabile

Les références du constructeur sont seulement indicatives et n'impliquent pas que les pièces de rechange viennent du constructeur.
I codici di riferimento originali sono indicativi e non implicano che i ricambi provengano necessariamente dalla stessa fabbrica del costruttore.

PARTIE CYCLE PARTI CICLISTA
PARE BRISE PARABREZZA

TNT
Original

TNT
Tuning



***YAMAHATMAX 500 2008**
368000K



TYPE VESPA
405221A KIT DE FIXATION SUR RETROVISEUR



UNIVERSEL UNIVERSALE
405221



SMARTPHONE / GPS

LEKTRONIS
ELECTRONIC



**SUPPORT UNIVERSEL IMPERMEABLE POUR
SMARTPHONE / GPS**
CUSTODIA IMPERMEABILE SMARTPHONE
UNIVERSALE
540016G MONTAGE GUIDON FISSAGGIO MANUBRIO



**SUPPORT UNIVERSEL IMPERMEABLE POUR
SMARTPHONE / GPS**
CUSTODIA IMPERMEABILE SMARTPHONE
UNIVERSALE
540016F MONTAGE RETROVISEUR FISSAGGIO RETROVISOR

**MANCHON RIGIDE
COPRIMANI**

TNT
Original

**MANCHON RIGIDE SCOOTER UNIVERSEL
PORTATARGA SCOOTER UNIVERSALE**
503359C



CARROSSERIE

- > *TREKKER
- > *SPEEDFIGHT 2
- > *LUDIX AIR COOLED
- > *OVETTO
- > *NRG MC2 EXTREME
- > *TYPHOON
- > *BOOSTER BW'S 1999-2003
- > *BOOSTER 2004 BW'S 2004
- > *BOOSTER SPIRIT / BW'S
- > *NEXT ROCKET
- > *STUNT / SLIDER
- > *NITRO AEROX
- > *STALKER
- > *MACH G / JOG R
- > *ZIP
- > *LIBERTY 50
- > *GRIDO
- > *DERBI SENDA DRD 00 > 05
- > *DERBI SENDA R - SM - XTREM - X RACE 00 > 08
- > *TMAX 500 04 > 08
- > *X-MAX 125 / 250
- > *SH 125 150 2006
- > *SH 300i
- > *PCX 125

CARENA

CARROSSERIE CARENA SCOOTER

> *LUDIX AIR COOLED



NOIR METAL NERO METAL



366350A 10" AV. ANT.



366350B 14" AV. ANT.



366350E



366350C 10" ARR. POST.



366350D 14" ARR. POST.

KIT COMPLET KIT COMPLETO



366350 5 PIECES PEZZI

BLANC BIANCO



366352A 10" AV. ANT.



366352B 14" AV. ANT.



366352E



366352C 10" ARR. POST.

KIT COMPLET KIT COMPLETO



366352 5 PIECES PEZZI

STYLE CARBONE CARBONIO



366353A 10" AV. ANT.



366353B 14" AV. ANT.



366353E



366353C 10" ARR. POST.



366353D 14" ARR. POST.

KIT COMPLET KIT COMPLETO



366353 5 PIECES PEZZI



**NOIR A PEINDRE
NERO DA VERNICIARE**
366110



**BLEU METAL
BLU METAL**
366111



**BLANC
BIANCO**
366112



**ROUGE SCUDERIA
ROSSO SCUDERIA**
366113



**STYLE CARBONE
CARBONIO**
366114

CARROSSERIE CARENA SCOOTER

> *TREKKER



NOIR METAL NERO METAL

KIT COMPLET KIT COMPLETO



BLANC BIANCO

KIT COMPLET KIT COMPLETO

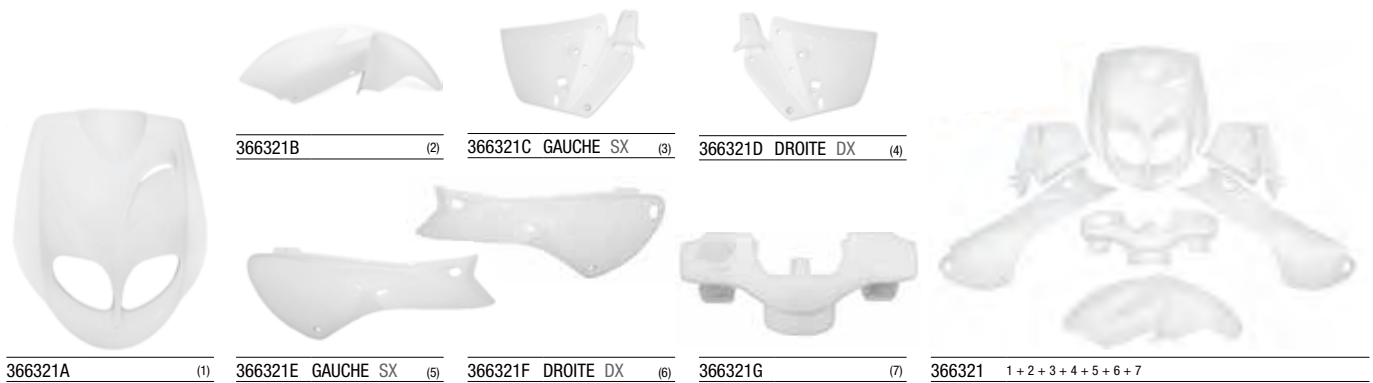

BLEU METAL BLU METAL

KIT COMPLET KIT COMPLETO



* Adaptable
* Adattabile

Les références du constructeur sont seulement indicatives et n'impliquent pas que les pièces de rechange viennent du constructeur.
I codici di riferimento originali sono indicativi e non implicano che i ricambi provengano necessariamente dalla stessa fabbrica del costruttore.

CARROSSERIE CARENA SCOOTER

> *SPEEDFIGHT 2















NOIR METAL NERO METAL

KIT COMPLET KIT COMPLETO

				
366880A (1)	366880B (2)	366880C (3)	366880E (4)	
				
366880H GAUCHE SX (9)	366880K GAUCHE SX (11)	366880D GAUCHE SX (5)	366880F GAUCHE SX (7)	
366880I DROITE DX (10)	366880L DROITE DX (12)	366880J DROITE DX (6)	366880G DROITE DX (8)	
				
366880M (13)	366880N	3668800	366880 1 + 2 + 3 + 4 + 5 + 6 + 7 + 8 + 9 + 10 + 11 + 12 + 13	

BLANC BIANCO

KIT COMPLET KIT COMPLETO

				
366882A (1)	366882B (2)	366882C (3)	366882E (4)	
				
366882H GAUCHE SX (9)	366882K GAUCHE SX (11)	366882D GAUCHE SX (5)	366882F GAUCHE SX (7)	
366882I DROITE DX (10)	366882L DROITE DX (12)	366882J DROITE DX (6)	366882G DROITE DX (8)	
				
366882M (13)	366882N	3668820	366882 1 + 2 + 3 + 4 + 5 + 6 + 7 + 8 + 9 + 10 + 11 + 12 + 13	











CARROSSERIE CARENA SCOOTER

> *SPEEDFIGHT 2



BLEU METAL BLU METAL

KIT COMPLET KIT COMPLETO

				
366884A (1)	366884B (2)	366884C (3)	366884 1 + 2 + 3 + 4 + 5 + 6 + 7 + 8 + 9 + 10 + 11 + 12 + 13	
				
366884K GAUCHE SX (11)	366884L DROITE DX (12)	366884D GAUCHE SX (5)	366884J DROITE DX (6)	366884F GAUCHE SX (7)
				366884G DROITE DX (8)
				
366884M (13)	366884N	366884O		

NOIR A PEINDRE NERO DA VERNICIARE

KIT COMPLET KIT COMPLETO

					
366885A (1)	366885B (2)	366885C (3)	366885E (4)	366885 1 + 2 + 3 + 4 + 5 + 6 + 7 + 8 + 9 + 10 + 11 + 12 + 13	
					
366885H GAUCHE SX (9)	366885I DROITE DX (10)	366885K GAUCHE SX (11)	366885L DROITE DX (12)	366885D GAUCHE SX (5)	366885J DROITE DX (6)
					366885F GAUCHE SX (7)
					366885G DROITE DX (8)
					
366885M (13)	366885N	366885O			

* Adaptable
* Adattabile

Les références du constructeur sont seulement indicatives et n'impliquent pas que les pièces de rechange viennent du constructeur.
I codici di riferimento originali sono indicativi e non implicano che i ricambi provengano necessariamente dalla stessa fabbrica del costruttore.

CARROSSERIE CARENA SCOOTER

> *BOOSTER BW'S 1999-2003



NOIR METAL NERO METAL

KIT COMPLET KIT COMPLETO



BLEU HAWAII BLU HAWAII

KIT COMPLET KIT COMPLETO



BLANC BIANCO

KIT COMPLET KIT COMPLETO



CARROSSERIE CARENA SCOOTER

> *BOOSTER BW'S 1999-2003



BLEU HAWAI BLU COCKTAIL



366951



366423

(5)



366422

(3)



366422A



366423A



366424

(7)



366425

(6)



366420

(1)



366421



366419 1 + 3 + 5 + 6 + 7

KIT COMPLET KIT COMPLETO

ROUGE SCUDERIA ROSSO SCUDERIA



366959



366602

(5)



366601

(3)

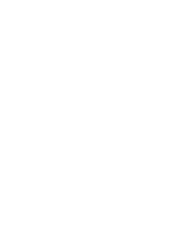

366605

(7)



366603

(6)



366600

(1)



366605A



366599 1 + 3 + 5 + 6 + 7

KIT COMPLET KIT COMPLETO

BLANC METAL BIANCO METAL



366953



366438

(5)



366437

(3)



366439

(6)



366436

(1)



366438A

(7)



366435A 1 + 3 + 5 + 6 + 7

KIT COMPLET KIT COMPLETO

CARROSSERIE CARENA SCOOTER

> *BOOSTER BW'S 1999-2003



BLEUE METAL BLU METAL

KIT COMPLET KIT COMPLETO



366200D

(5)



366200C

(3)



366200F

(6)



366200A

(1)



366200E

(7)



366200 1+3+5+6+7

VERT JAGUAR VERDE JAGUAR

KIT COMPLET KIT COMPLETO



366199 1+3+5+6+7

NOIR A PEINDRE NERO DA VERNICIARE



998



366404



366403



366403A



366401 *BOOSTER NM



366402

366400 *BOOSTER AM



366404A



366900



365999

CARROSSERIE CARENA SCOOTER

> *BOOSTER 2004 BW'S 2004



NOIR METAL NERO METAL



KIT COMPLET KIT COMPLETO



BLANC METAL BIANCO METAL



> *BOOSTER 2004 BW'S 2004



NOIR METAL NERO METAL



KIT COMPLET KIT COMPLETO



BLANC METAL BIANCO METAL



KIT COMPLET KIT COMPLETO



* Adaptable
* Adattabile

Les références du constructeur sont seulement indicatives et n'impliquent pas que les pièces de rechange viennent du constructeur.
I codici di riferimento originali sono indicativi e non implicano che i ricambi provengano necessariamente dalla stessa fabbrica del costruttore.

CARROSSERIE CARENA SCOOTER

> *BOOSTER 2004 BW'S 2004

TNT
Original



***BOOSTER SPIRIT BW'S 2004**

MARCHE PIED
PEDANA

365995 NOIR NERO
365995A BLANC BIANCO



***BOOSTER SPIRIT BW'S 2004**

CACHE INFERIEUR CHASSIS
SOTTOPEDANA

365993 NOIR NERO
365993A BLANC BIANCO



***BOOSTER SPIRIT / BW'S**

GARDE BOUE ARRIERE
PARAFANGO POSTERIORE

380325A



***BOOSTER SPIRIT BW'S 2004**

BAS DE GUIDON
CUPOLINO INTERNO MANUBRIO

366411A NOIR NERO



***BOOSTER SPIRIT BW'S 2004**

TRAPPE BATTERIE
SPORTELLINO MARMITTA

366415B NOIR NERO



***BOOSTER SPIRIT BW'S 2004**

COFFRE DE SELLE
VANO SOTTO SELLA

380325B NOIR NERO

> BOOSTER SPIRIT / BW'S

FACO TNT
Original



***BOOSTER SPIRIT BW'S**

MARCHE PIED
PEDANA

365996 NOIR NERO



***BOOSTER SPIRIT BW'S**

CACHE INFERIEUR CHASSIS
SOTTOPEDANA

365997 NOIR NERO



***BOOSTER SPIRIT BW'S**

GARDE BOUE ARRIERE
PARAFANGO POSTERIORE

380331 A PEINDRE DA VERNICIARE



***BOOSTER SPIRIT / BW'S**

GARDE BOUE ARRIERE
PARAFANGO POSTERIORE

380325

> FIXATION CARROSSERIE FISSAGGIO CARENA

TNT
Tuning



VIS DE CARROSSERIE VITI CARENA

	ALU BLEU ALL. BLU	ALU ROUGE ALL. ROSSO	ACIER CHR ACCIAIO CRO.
*BOOSTER/BW'S	171100	171104	171103
*NEXT			171108
*NITRO			171123
*TYPHOON/NRG	171180		171183

NEW

Visuel non disponible
Unavailable picture



**AGRAFES DE CARROSSERIE
GRAFFETTE CARENA** X10

170900B	10 M5
170900C	10 M6
170900D	10 M8

**AGRAFES DE CARROSSERIE
GRAFFETTE CARENA** X20

170900	20 M4 x 10 KIT
170900A	20 M5 x 15

CARROSSERIE CARENA SCOOTER

> *NEXT ROCKET



ROUGE SCUDERIA ROSSO SCUDERIA



NOIR A PEINDRE NERO DA VERNICIARE



BLANC BIANCO



NOIR METAL NERO METAL



STYLE CARBONE CARBONIO

366525

* Adaptable
* Adattabile

Les références du constructeur sont seulement indicatives et n'impliquent pas que les pièces de rechange viennent du constructeur.
I codici di riferimento originali sono indicativi e non implicano che i ricambi provengano necessariamente dalla stessa fabbrica del costruttore.

CARROSSERIE CARENA SCOOTER

> *STUNT / SLIDER



NOIR METAL NERO METAL

KIT COMPLET KIT COMPLETO



366301A (1)
Livré sans éclairage
Fari non compresi



366301B DROITE DX (2)
366301C GAUCHE SX (3)



366301D (4)



366301E DROITE DX (5)
366301F GAUCHE SX (6)



366301G (7)



366301J



366301K



366301 1+2+3+4+5+6+7+8+9

BLANC BIANCO

KIT COMPLET KIT COMPLETO



366302D (4)



366302G (7)



366302J



366302K



366302 1+2+3+4+5+6+7+8+9

NOIR A PEINDRE NERO DA VERNICIARE

KIT COMPLET KIT COMPLETO



KIT 2 CABOCHONS PHARE KIT 2 GEMME FARO

370524

Le kit complet 9 pièces *STUNT est livré avec le «kit 2 cabochons» ref : 366310 + 2 ampoules réf : 220094 + 2 douilles réf : 220094A.

il Kit COMPLETO 9 pezzi *STUNT è consegnato con il «kit 2 GEMME» ref: 366310 + 2 lampadine codice: 220094 + 2 connettori codice: 220094A.



366300

CARROSSERIE CARENA SCOOTER

> *STUNT / SLIDER 2004>

TNT
Original

NOIR NERO

BLANC BIANCO

KIT COMPLET KIT COMPLETO

KIT COMPLET KIT COMPLETO



366308 NOIR NERO



366308A BLANC BIANCO



366308B NOIR NERO



366308C BLANC BIANCO



**KIT 4 PROTECTIONS CARROSSERIE
KIT 4 PROTEZIONI CARENA**

590504A NOIR NERO



**KIT 4 PROTECTIONS CARROSSERIE
KIT 4 PROTEZIONI CARENA**

590504 BLANC BIANCO

* Adaptable
* Adattabile

Les références du constructeur sont seulement indicatives et n'impliquent pas que les pièces de rechange viennent du constructeur.
I codici di riferimento originali sono indicativi e non implicano che i ricambi provengano necessariamente dalla stessa fabbrica del costruttore.

CARROSSERIE CARENA SCOOTER

> *NITRO AEROX 1997-2012



ROUGE SCUDERIA RED SCUDERIA



- | | | | |
|------------|------------|----------------------|------------------|
| 366742 (3) | 366743A | 366743 (4) | 366748A |
| 366740 (1) | 366741 (2) | 366745 GAUCHE SX (6) | 366747 GAUCHE SX |
| | | 366746 DROITE DX (7) | 366748 DROITE DX |
| 366744 (5) | 366744A | | |

KIT COMPLET KIT COMPLETO



366749 1+2+3+4+5+6+7

GRIS METAL GRIGIO METAL



- | | | | |
|------------|------------|----------------------|------------------|
| 366722 (3) | 366723A | 366723 (4) | 366728A |
| 366720 (1) | 366721 (2) | 366725 GAUCHE SX (6) | 366727 GAUCHE SX |
| | | 366726 DROITE DX (7) | 366728 DROITE DX |
| 366724 (5) | | | |

KIT COMPLET KIT COMPLETO



366729 1+2+3+4+5+6+7

NOIR METAL NERO METAL



- | | | | |
|------------|------------|----------------------|------------------|
| 366732 (3) | 366733A | 366733 (4) | 366738A |
| 366730 (1) | 366731 (2) | 366735 GAUCHE SX (6) | 366737 GAUCHE SX |
| | | 366736 DROITE DX (7) | 366738 DROITE DX |
| 366734 (5) | 366734A | | |

KIT COMPLET KIT COMPLETO



366739 1+2+3+4+5+6+7

CARROSSERIE CARENA SCOOTER

> *NITRO AEROX 1997-2012



NOIR A PEINDRE NERO DA VERNICIARE

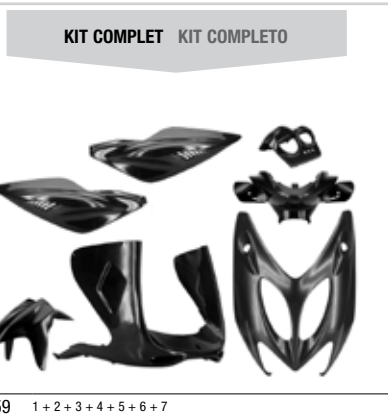

BLANC BIANCO



BLEU METAL BLU METAL

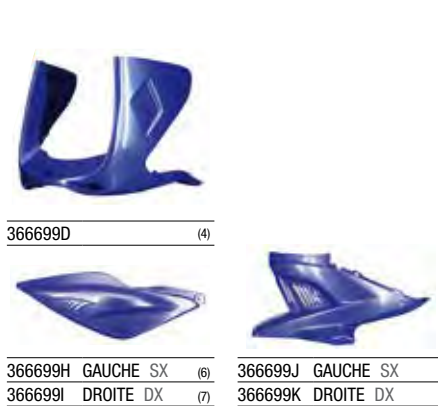

* Adaptable
* Adattabile

Les références du constructeur sont seulement indicatives et n'impliquent pas que les pièces de rechange viennent du constructeur.
I codici di riferimento originali sono indicativi e non implicano che i ricambi provengano necessariamente dalla stessa fabbrica del costruttore.

CARROSSERIE CARENA SCOOTER

> *NITRO AEROX 1997-2013



STYLE CARBONE CARBONIO



CHROME CROMO

KIT COMPLET KIT COMPLETO



> *NITRO AEROX 2013



NOIR MAT NERO OPACO

KIT COMPLET KIT COMPLETO



CARROSSERIE CARENA SCOOTER

> *NITRO AEROX



***NITRO AEROX**
MARCHE PIED PEDANA
 365994 NOIR NERO
 365994A BLANC BIANCO



***NITRO AEROX**
TRAPPE BATTERIE COPRI BATTERIA
 365994B



***NITRO AEROX**
DOSERET DE SIEGE
COPERCHIO SERBATOI
 580400 BLANC BIANCO
 580400A NOIR METAL NERO METAL
 580400C STYLE CARBONE CARBONIO
 580400D ROUGE SCUDERIA ROSSO SCUD



***NITRO AEROX**
POIGNEE DE SELLE
MANIGLIE PASSEGERO
 580410 BLANC BIANCO
 580410A NOIR NERO
 580410C STYLE CARBONE CARBONIO
 580410E JAUNE GIALLO

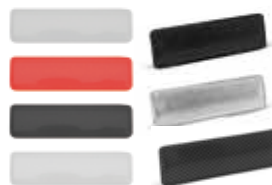

***BOOSTER / BW'S / NITRO / AEROX**
PLAQUE CACHE NUMERO
COPRI DATI TELAIO
 366470 NOIR NERO
 366471 CHROME CROMO
 366472A BLANC BIANCO
 366472B ROUGE SCUDERIA ROSSO SCUD
 366472C NOIR METAL NERO METAL
 366472E BLANC METAL BIANCO META
 366473 STYLE CARBONE CARBONIO

> *STALKER 1997-2011



BLANC BIANCO



366108



366108A



366108B GAUCHE SX

366108C DROITE DX



366108D

NOIR METAL NERO METAL



366109



366109A



366109B GAUCHE SX

366109C DROITE DX



366109D

* Adaptable
 * Adattabile

Les références du constructeur sont seulement indicatives et n'impliquent pas que les pièces de rechange viennent du constructeur.
 I codici di riferimento originali sono indicativi e non implicano che i ricambi provengano necessariamente dalla stessa fabbrica del costruttore.

CARROSSERIE CARENA SCOOTER

> *OVETTO 2007

TNT
Original

NOIR METAL NERO METAL



366330A (1)



366330E GAUCHE SX (2)
366330F DROITE DX (3)



366330G (7)



366330C GAUCHE SX (4)
366330D DROITE DX (5)



366330B (6)

KIT COMPLET KIT COMPLETO



366330 1+2+3+4+5+6+7

BLANC BIANCO



366331A (1)



366331E GAUCHE SX (2)
366331F DROITE DX (3)



366331G (7)



366331C GAUCHE SX (4)
366331D DROITE DX (5)



366331B (6)

KIT COMPLET KIT COMPLETO



366331 1+2+3+4+5+6+7

A PEINDRE DA VERNICIARE

FACO



365519B

> *NRG MC2 EXTREME

A PEINDRE DA VERNICIARE

FACO



365926

> *TYPHOON

A PEINDRE DA VERNICIARE

FACO



365900



365901



365902 DROITE DX
365903 GAUCHE SX

CARROSSERIE CARENA SCOOTER

> *MACH G / JOG R



BLANC BIANCO



366867F (1)



366867C GAUCHE SX (2)
366867D DROITE DX (3)



366867G GAUCHE SX (4)
366867H DROITE DX (5)



366867I (6)



366867E (7)



366867A (8)



366867B (9)



366867 1+2+3+4+5+6+7+8+9

KIT COMPLET KIT COMPLETO

ROUGE SCUDERIA ROSSO SCUDERIA



366868F (1)



366868C GAUCHE SX (2)
366868D DROITE DX (3)



366868G GAUCHE SX (4)
366868H DROITE DX (5)



366868E (7)



366868A (8)



366868B (9)



366868 1+2+3+4+5+6+7+8+9

KIT COMPLET KIT COMPLETO

NOIR METAL NERO METAL



366861F (1)



366861C GAUCHE SX (2)
366861D DROITE DX (3)



366861G GAUCHE SX (4)
366861H DROITE DX (5)



366861I (6)



366861E (7)



366861A (8)



366861B (9)



366861 1+2+3+4+5+6+7+8+9

KIT COMPLET KIT COMPLETO

> *KYMCO AGILITY 50 / 125 07-08



NOIR NERO



366104B



366104A



366104



366104E



366104D GAUCHE SX
366104C DROITE DX

* Adaptable
* Adattabile

Les références du constructeur sont seulement indicatives et n'impliquent pas que les pièces de rechange viennent du constructeur.
I codici di riferimento originali sono indicativi e non implicano che i ricambi provengano necessariamente dalla stessa fabbrica del costruttore.

CARROSSERIE CARENA SCOOTER

> *ZIP 50 2T LC 2000-2013

TNT
Original

BLANC BIANCO

KIT COMPLET KIT COMPLETO



366341A (1)



366341D (2)



366341C (3)



366341E (4)



366341F (5)



366341I (6)



366341 1+2+3+4+5+6

NOIR METAL NERO METAL

KIT COMPLET KIT COMPLETO



366340A (1)



366340D (2)



366340C (3)



366340E (4)



366340F (5)



366341J (6)



366340 1+2+3+4+5+6

> *ZIP 50 2T C / 4T

TNT
Original

NOIR METAL NERO METAL

KIT COMPLET KIT COMPLETO



366340G (1)



366340E (2)



366340F (3)



366340B (4)



366340H 1+2+3+4

BLANC BIANCO

KIT COMPLET KIT COMPLETO



366341G (1)



366341E (2)



366341F (3)



366341B (4)



366341H 1+2+3+4

CARROSSERIE CARENA SCOOTER

> *PIAGGIO LIBERTY 50/125/150/200 2004-2014

TNT
Original

NOIR METAL NERO METAL

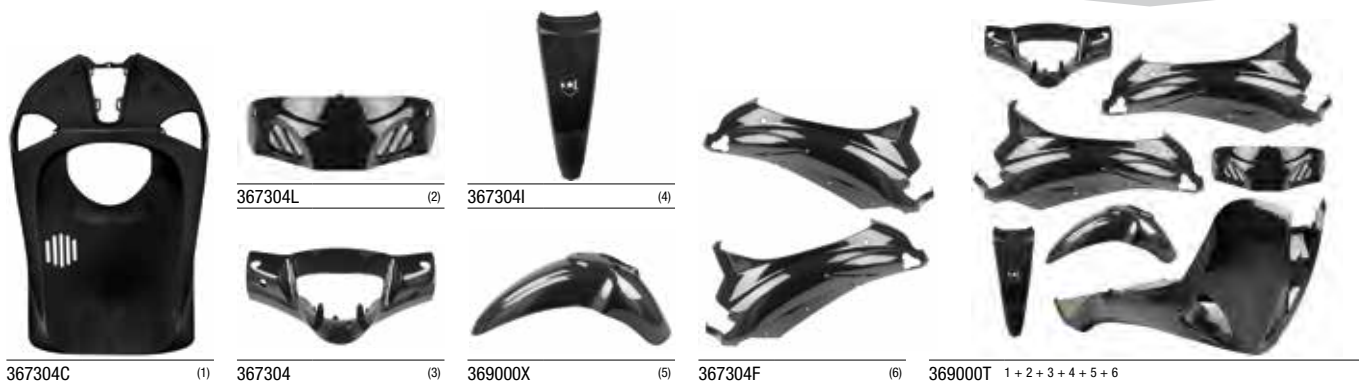

KIT COMPLET KIT COMPLETO

BLANC BIANCO

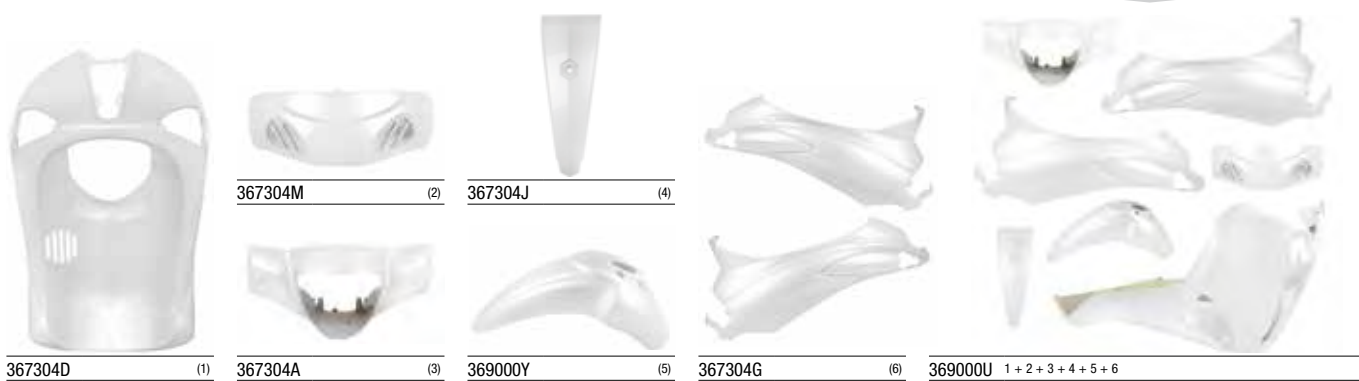

KIT COMPLET KIT COMPLETO

BLANC BIANCO

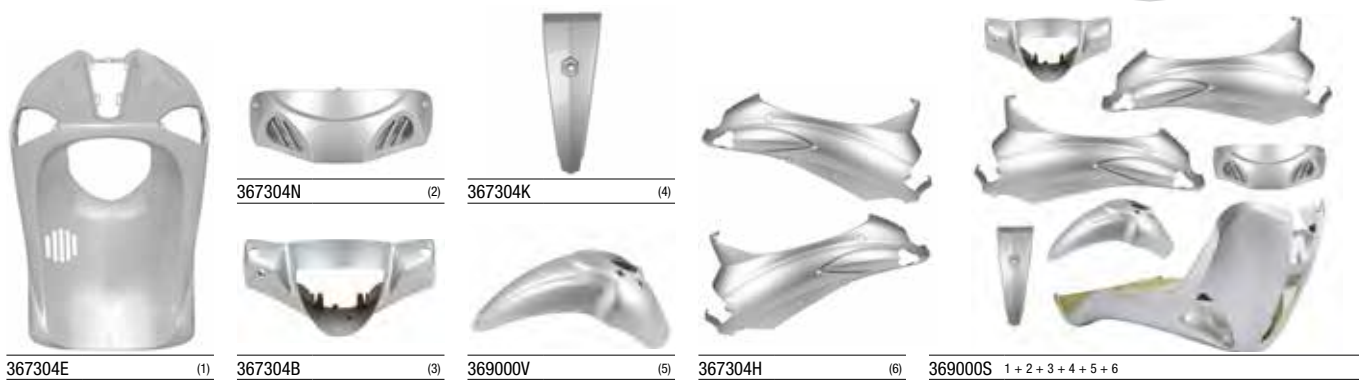

KIT COMPLET KIT COMPLETO



***PIAGGIO LIBERTY 50/12/150/200 (2004 - 2014)**
KIT COMPLET KIT COMPLETO
369000Z ROUGE ROSSO 7 PIECES

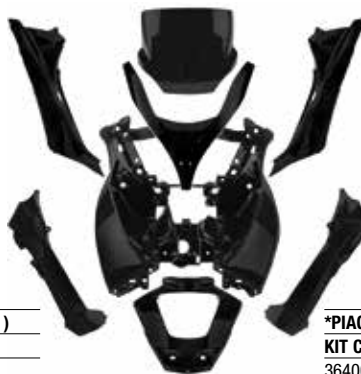

***PIAGGIO MP3 125/250/300/400/500 (2008 - 2013)**
KIT COMPLET KIT COMPLETO
364000 NOIR MAT NERO OPACO 8 PIECES

* Adaptable
* Adattabile

Les références du constructeur sont seulement indicatives et n'impliquent pas que les pièces de rechange viennent du constructeur.
I codici di riferimento originali sono indicativi e non implicano che i ricambi provengano necessariamente dalla stessa fabbrica del costruttore.

CARROSSERIE CARENA SCOOTER

> *PIAGGIO LX 50

TNT
Original

A PEINDRE DA VERNICIARE



366118



366118B



366118A



366118G



366118E



366118F



366118D DROITE DX
366118C GAUCHE SX

> GARDE BOUE AVANT PARAFANGO ANTERIORE

TNT
Original



***PIAGGIO LIBERTY 50**
366118K A PEINDRE DA VERNICIARE



***PIAGGIO NRG - NTT - MC2**
366118J A PEINDRE DA VERNICIARE

> *MALAGUTI F12 LC

TNT
Original



***MALAGUTI F12 LC (2002 - 2006)**
KIT COMPLET KIT COMPLETO
366309 NOIR BRILLANT NERO 9 PIECES

*GILERA RUNNER

TNT
Original



***GILERA RUNNER 50/125/150 (1997 - 2004)**
KIT COMPLET KIT COMPLETO
366311 NOIR BRILLANT NERO 13 PIECES

> *SCARABEO 50 / 100 2001-2012

TNT
Original

A PEINDRE DA VERNICIARE



365904



365904G



365904E



365904B



365904A



365904C



365904F



365904D

CARROSSERIE CARENA

50CC A BOITE 50CC A MARCE

> *DERBI SENDA DRD > O5 / R-SM-XTREM-X RACE > O8



KIT COMPLET KIT COMPLETO

ROUGE SCUDERIA ROSSO SCUDERIA

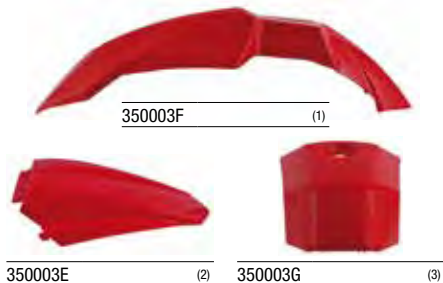

350003F (1) 350003E (2) 350003G (3) 350003B GAUCHE SX (4) 350003A DROITE DX (5) 350003D GAUCHE SX (6) 350003C DROITE DX (7) 350003 1+2+3+4+5+6+7

NOIR NERO

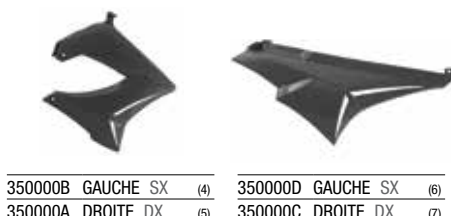
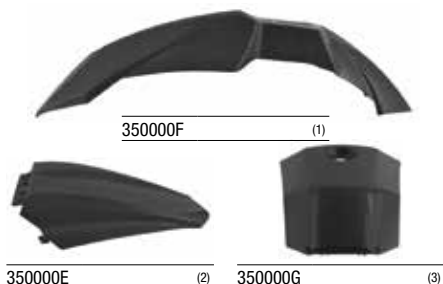

350000F (1) 350000E (2) 350000G (3) 350000B GAUCHE SX (4) 350000A DROITE DX (5) 350000D GAUCHE SX (6) 350000C DROITE DX (7) 350000 1+2+3+4+5+6+7

BLANC BIANCO

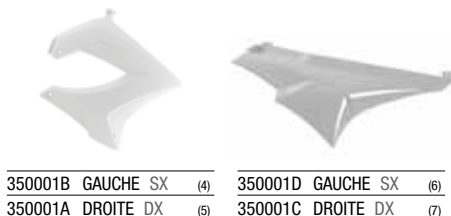
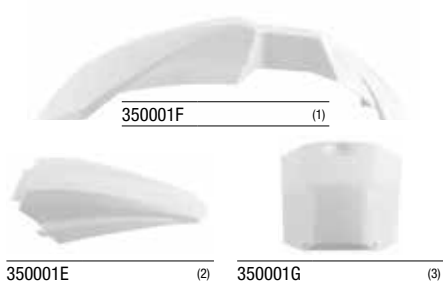

350001F (1) 350001E (2) 350001G (3) 350001B GAUCHE SX (4) 350001A DROITE DX (5) 350001D GAUCHE SX (6) 350001C DROITE DX (7) 350001 1+2+3+4+5+6+7

BLEU BLU

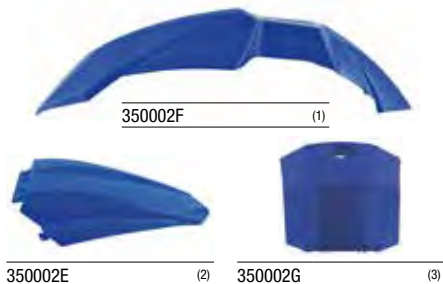

350002F (1) 350002E (2) 350002G (3) 350002B GAUCHE SX (4) 350002A DROITE DX (5) 350002D GAUCHE SX (6) 350002C DROITE DX (7) 350002 1+2+3+4+5+6+7

ORANGE ARANCIONE

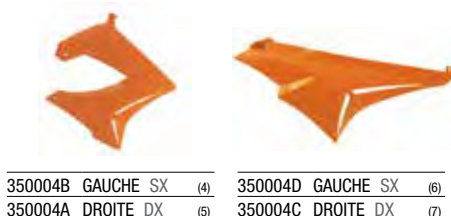
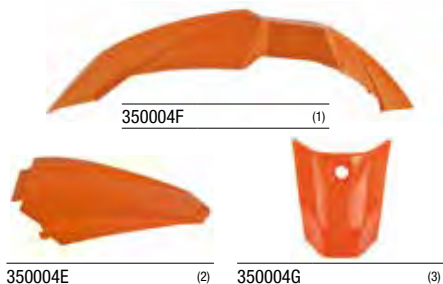

350004F (1) 350004E (2) 350004G (3) 350004B GAUCHE SX (4) 350004A DROITE DX (5) 350004D GAUCHE SX (6) 350004C DROITE DX (7) 350004 1+2+3+4+5+6+7

* Adaptable
* Adattabile

Les références du constructeur sont seulement indicatives et n'impliquent pas que les pièces de rechange viennent du constructeur.
I codici di riferimento originali sono indicativi e non implicano che i ricambi provengano necessariamente dalla stessa fabbrica del costruttore.

CARROSSERIE CARENA

50CC A BOITE 50CC A MARCE

> *DERBI SENDA DRD RACING / LIMITED O4 > 10

TNT
Original

NOIR NERO



350009B (1)



350009A (8)



350009H (3)

350009F GAUCHE SX (6)
350009E DROITE DX (7)

350009D GAUCHE SX (4)
350009C DROITE DX (5)

350009G (2)



KIT COMPLET KIT COMPLETO
350009 1+2+3+4+5+6+7+8

> *DERBI SENDA DRD XTREME 10 > 15

TNT
Original

NOIR NERO



350012B (1)



350012F (3)



350012E (2)



350012A (4)



350012D GAUCHE SX (5)
350012C DROITE DX (6)



KIT COMPLET KIT COMPLETO
350012 1+2+3+4+5+6

BLANC BIANCO



350013B (1)



350012F (3)



350013E (2)



350013A (4)



350013D GAUCHE SX (5)
350013C DROITE DX (6)



KIT COMPLET KIT COMPLETO
350013 1+2+3+4+5+6

CARROSSERIE CARENA

50CC A BOITE 50CC A MARCE

> *CPI SM/SX 50

TNT
Original



KIT CAROSSERIE 8 PIECES
KIT CARENA 8 PEZZI
351000 NOIR NERO

KIT CAROSSERIE 8 PIECES
KIT CARENA 8 PEZZI
351000A BLANC BIANCO

> *RIEJU MRT 50

TNT
Original



N
NEW

KIT CAROSSERIE 7 PIECES
KIT CARENA 7 PEZZI
352000 NOIR NERO
353000 BLANC BIANCO

N
NEW

GARDE-BOUE PARAFANGO
352000A NOIR NERO
353000A BLANC BIANCO



* Adaptable
* Adattabile

Les références du constructeur sont seulement indicatives et n'impliquent pas que les pièces de rechange viennent du constructeur.
I codici di riferimento originali sono indicativi e non implicano che i ricambi provengano necessariamente dalla stessa fabbrica del costruttore.

CARROSSERIE CARENA MAXISCOOTER

> *X-MAX 125 / 250 <2010

TNT
Original

NOIR A PEINDRE NERO DA VERNICIARE

KIT COMPLET KIT COMPLETO



NOIR MAT NERO OPACO

NOIR BRILLANT NERO LUCIDO



> *X-MAX 125 <2010

TNT
Original

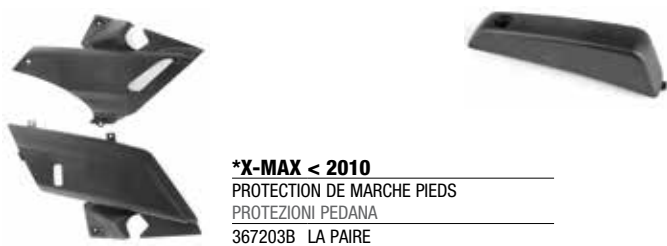

> *XMAX 125 2010-2016

TNT
Original



CARROSSERIE CARENA MAXISCOOTER

> *X-MAX 125 / 250 2014-2017

TNT
Original

N
NEW

KIT CARROSSERIE 11 PIECES

KIT CARENA 11 PEZZI

367204 NOIR NERO

367205 WHITE COMPETITION

367206 NOIR MAT NERO OPACO

N
NEW

GARDE-BOUE

PARAFANGO

367204A NOIR NERO

367205A WHITE COMPETITION

367206A NOIR MAT NERO OPACO



* Adaptable
* Adattabile

Les références du constructeur sont seulement indicatives et n'impliquent pas que les pièces de rechange viennent du constructeur.
I codici di riferimento originali sono indicativi e non implicano che i ricambi provengano necessariamente dalla stessa fabbrica del costruttore.

AS 191

CARROSSERIE CARENA MAXISCOOTER

> *TMAX 500 2001-2007 - PHASE 1



NOIR A PEINDRE NERO DA VERNICIARE



KIT COMPLET KIT COMPLETO



367000 1 + 2 + 3 + 4 + 5 + 6 + 7 + 8 + 9 + 10 + 11 + 12

NOIR MAT NERO OPACO



KIT COMPLET KIT COMPLETO
367007

NOIR BRILLANT NERO LUCIDO



KIT COMPLET KIT COMPLETO
367001



NOIR MAT NERO OPACO



KIT COMPLET KIT COMPLETO
363000 12 PIECES PEZZI

NOIR BRILLANT NERO LUCIDO



KIT COMPLET KIT COMPLETO
365000 10 PIECES PEZZI



*TMAX 500 2001-2007
CAPOT MOTEUR TAPO MOTORE
NOIR BRILLANT NERO LUCIDO
365000G GAUCHE SINISTRA
365000H DROITE DESTRA



GARDE BOUE ARRIERE
PARAFANGO POSTERIORE
368000J



PROTECTION DE MARCHÉ PIEDS
PROTEZIONI PEDANA
368000Z CHROM

CARROSSERIE CARENA MAXISCOOTER

> *TMAX 500 2001-2007 - PHASE 2

TNT
Original

NOIR MAT NERO OPACO



370000P



3690000



370000S



370000G GAUCHE SX
370000J DROITE DX



370000A GAUCHE SX
370000D DROITE DX

KIT COMPLET KIT COMPLETO



369000K 1+2+3+4+5+6+7+8+9+10+11+12+13

BLANC BIANCO



369000P



370000I GAUCHE SX
370000L DROITE DX



370000A GAUCHE SX
370000D DROITE DX

KIT COMPLET KIT COMPLETO



369000L 1+2+3+4+5+6+7+8+9+10+11+12+13

NOIR BRILLANT NERO LUCIDO



370000Q



369000Q



370000R



370000H GAUCHE SX
370000K DROITE DX



370000B GAUCHE SX
370000E DROITE DX

KIT COMPLET KIT COMPLETO



369000M 1+2+3+4+5+6+7+8+9+10+11+12+13

NOIR A PEINDRE NERO DA VERNICIARE



369000R

KIT COMPLET KIT COMPLETO



369000N 1+2+3+4+5+6+7+8+9+10+11+12+13

* Adaptable
* Adattabile

Les références du constructeur sont seulement indicatives et n'impliquent pas que les pièces de rechange viennent du constructeur.
I codici di riferimento originali sono indicativi e non implicano che i ricambi provengano necessariamente dalla stessa fabbrica del costruttore.

CARROSSERIE CARENA MAXISCOOTER

> *TMAX 530 2012-2014 - PHASE 3

TNT
Original

NOIR BRILLANT NERO LUCIDO



367305K



367305J



369000Q



367305A



367305D GAUCHE SX
367305E DROITE DX



367305B GAUCHE SX
367305C DROITE DX



367305H GAUCHE SX
367305I DROITE DX



367305F GAUCHE SX
367305G DROITE DX

KIT COMPLET KIT COMPLETO



367305 1+2+3+4+5+6+7+8+9+10

BLANC BIANCO



367307K



367307J



369000P



367306A



367307D GAUCHE SX
367307E DROITE DX



367306B GAUCHE SX
367306C DROITE DX



367306H GAUCHE SX
367306I DROITE DX



367306F GAUCHE SX
367306G DROITE DX

KIT COMPLET KIT COMPLETO



367306 1+2+3+4+5+6+7+8+9+10

NOIR MAT NERO OPACO



367307K



367307J



3690000



367307A



367307D GAUCHE SX
367307E DROITE DX



367307B GAUCHE SX
367307C DROITE DX



367307H GAUCHE SX
367307I DROITE DX



367307F GAUCHE SX
367307G DROITE DX

KIT COMPLET KIT COMPLETO



367307 1+2+3+4+5+6+7+8+9+10

GRIS MAT GRIGIO OPACO



367307K



367307J



367308H



367308A



367307D GAUCHE SX
367307E DROITE DX



367308B GAUCHE SX
367308C DROITE DX



367308F GAUCHE SX
367308G DROITE DX



367308D GAUCHE SX
367308E DROITE DX

KIT COMPLET KIT COMPLETO



367308 1+2+3+4+5+6+7+8+9+10

CARROSSERIE CARENA MAXISCOOTER

> *TMAX 530 2015-2016



KIT COMPLET KIT COMPLETO
367310 NOIR BRILLANT NERO 14 PIECES



KIT COMPLET KIT COMPLETO
367312 NOIR MAT NERO OPACO 14 PIECES



KIT COMPLET KIT COMPLETO
367311 BLANC COMPETITION BIANCO 14 PIECES



GARDE-BOUE PARAFANGO
NOIR BRILLANT NER
367310A



GARDE-BOUE PARAFANGO
NOIR MAT NERO OPACO
367312A



GARDE-BOUE PARAFANGO
BLANC COMPETITION BIANCO
367311A



CAPOT MOTEUR TAPO MOTORE
NOIR BRILLANT NER
367310B GAUCHE SINISTRA
367310C DROITE DESTRA



RACCORD AVANT SOUS PHARE
BAFFO ANTERIORE SOTTO FARO
NOIR BRILLANT NERO
367310D

* Adaptable
* Adattabile

Les références du constructeur sont seulement indicatives et n'impliquent pas que les pièces de rechange viennent du constructeur.
I codici di riferimento originali sono indicativi e non implicano che i ricambi provengano necessariamente dalla stessa fabbrica del costruttore.

CARROSSERIE CARENA MAXISCOOTER

> *SH 125 / 150 2005-2008

TNT
Original

NOIR NERO



367300A (1)



367300C (3)



367300D (4)



367300E (5)



367300B (2)



367300F GAUCHE SX (7)



367300G DROITE DX (8)

KIT COMPLET KIT COMPLETO



367300 1+2+3+4+5+6+7+8+9+10

GRIS GRIGIO



367301A (1)



367301C (3)



367301D (4)



367301E (5)



367301B (2)



367301C (3)



367301D (4)



367301J (6)



367301F GAUCHE SX (7)



367301G DROITE DX (8)



367301H GAUCHE SX (9)



367301I DROITE DX (10)

KIT COMPLET KIT COMPLETO



367301 1+2+3+4+5+6+7+8+9+10

BLANC BIANCO



367302A (1)



367302C (3)



367302D (4)



367302E (5)



367302B (2)



367302C (3)



367302D (4)



367302J (6)



367302F GAUCHE SX (7)



367302G DROITE DX (8)



367302H GAUCHE SX (9)



367302I DROITE DX (10)

KIT COMPLET KIT COMPLETO



367302 1+2+3+4+5+6+7+8+9+10

CARROSSERIE CARENA MAXISCOOTER

> *SH 300i 2007-2010

TNT
Original

NOIR NERO



367350A



367350C



367350E



367350I GAUCHE SX



367350J DROITE DX



367350K



367350B

GRIS GRIGIO



367351F GAUCHE SX

367351G DROITE DX



367351E

BLANC BIANCO



367352A



367352C



367352D



367352E



367352H



367352F GAUCHE SX

367352G DROITE DX



367352I GAUCHE SX



367352J DROITE DX



367352K

> *PIAGGIO MP3 125/250/300/400/500 (2008 - 2013)

TNT
Original

NOIR MAT NERO OPACO



KIT COMPLET KIT COMPLETO
364000 8 PIECES

NOIR BRILLANT NERO LUCIDO



KIT COMPLET KIT COMPLETO
366000 8 PIECES

* Adaptable
* Adattabile

Les références du constructeur sont seulement indicatives et n'impliquent pas que les pièces de rechange viennent du constructeur.
I codici di riferimento originali sono indicativi e non implicano che i ricambi provengano necessariamente dalla stessa fabbrica del costruttore.

CARROSSERIE CARENA MAXISCOOTER

> *PCX 125 >2014

TNT
Original

BLANC BIANCO



369000E



369000G GAUCHE SX

369000I DROITE DX

KIT COMPLET KIT COMPLETO



369000B 1+2+3+4+5+6+7+8+9+10+11

BLANC BIANCO



369000D



369000F GAUCHE SX

369000H DROITE DX

KIT COMPLET KIT COMPLETO



369000C 1+2+3+4+5+6+7+8+9+10+11

> GARDE BOUE AVANT PARAFANGO ANTERIORE

TNT
Original



*VESPA ET2 - ET4

366118I A PEINDRE DA VERNICIARE



*VESPA GTS

366118H A PEINDRE DA VERNICIARE



*VESPA LX 50/125/150

366118G A PEINDRE DA VERNICIARE



*HONDA SH 2001-04

366300K A PEINDRE DA VERNICIARE



*PIAGGIO BEVERLY <2008

366118M NOIR NERO

ELECTRICITE

- > BATTERIE
- > BOUGIE
- > DEMARRAGE
- > ALLUMAGE
- > REGULATEUR
- > CONTACTEUR A CLE
- > COMMUTATEUR DE CONTACTEUR A CLE
- > COMPTEUR
- > ALARME

PARTI ELETTRICHE

- > BATTERIA
- > CANDELA
- > AVVIAMENTO
- > ACCENSIONE
- > REGOLATORE
- > KIT SERRATURA
- > CONTATTO CHIAVE
- > STRUMENTAZIONE
- > ALLARME



YUASA

LA BATTERIE

AU CŒUR DE VOTRE VÉHICULE



YB

FIBRE DE VERRE ROBUSTE
SÉPARATEUR SPÉCIALEMENT MINCE
RÉSISTANCE DE LA RÉDUCTION INTERNE
OPTIMISATION DE LA PUISSANCE
MÉCANISME D'ARRÊT DE LA SULFATATION

YT/ YTX®

ANTI-FUITE
TECHNOLOGIE INNOVANTE PLOMB-CALCIUM
RETARD DE LA SULFATATION
DURABILITÉ PROLONGÉE
RÉSISTANCE EXCEPTIONNELLE AUX VIBRATIONS
RECHARGE RAPIDE EN MODE STANDBY OU STOCKAGE

YTX®

BATTERIE ACTIVÉE AGM VRLA
UN SURCROÛT DE PUISSANCE – JUSQU'À
30 % DE CAPACITÉ DE DÉMARRAGE À FROID
SUPPLÉMENTAIRE GRÂCE À LA CONCEPTION
DE LEURS GRILLES RADIALES ET À LA PRÉSENCE
DE PLAQUES SUPPLÉMENTAIRES



**POWERS
THE WORLD**

WWW.YUASA.FR



YTX® & YTX® are trademarks of GS YUASA International Ltd.



(1)

BATTERIE AVEC ENTRETIEN
BATTERIA CON MANUTENZIONE

YB4L-B 12V 4A

229039

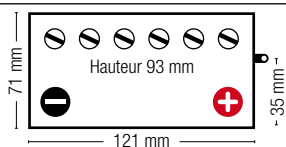

YB4L-B 12V 4A

229039A (livré avec Pack Acide)

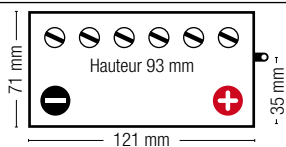

YB5L-B 12V 5A

229035Q

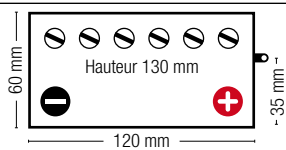

YB7-A 12V 8A

229035 (1)

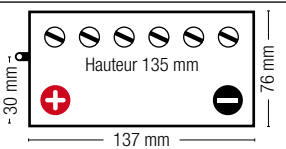

YB7L-B2 12V 8A

229035A

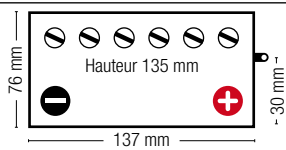

YB9-B 12V 9A

229035B

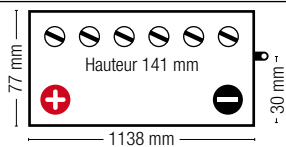

BATTERIE AVEC ENTRETIEN
BATTERIA CON MANUTENZIONE

YB10L-B2 12V 11A

229035C

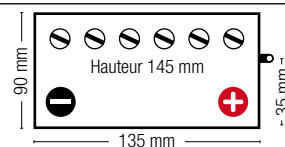

YB10L-BP 12V 11A

229035D

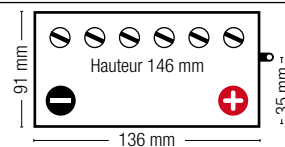

YB12AL-A 12V 12A

229035E

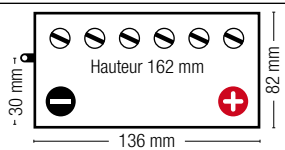

YB14AL-A2 12V 14A

229035M

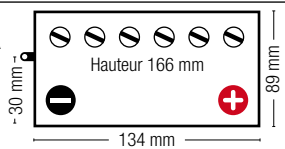

* Adaptable
* Adattabile

Les références du constructeur sont seulement indicatives et n'impliquent pas que les pièces de rechange viennent du constructeur.
I codici di riferimento originali sono indicativi e non implicano che i ricambi provengano necessariamente dalla stessa fabbrica del costruttore.



(1)

BATTERIE SANS ENTRETIEN
BATTERIA SENZA MANUTENZIONE

YTX4L-BS 12V 3A

229030E

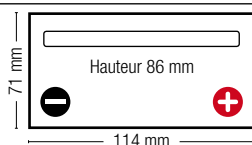

YTX5L-BS 12V 4A

229030

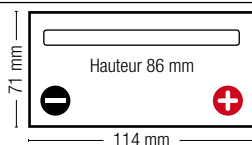

YTX7A-BS 12V 6A

229030A (1)

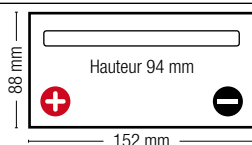

YTX7L-BS 12V 6A

229030B

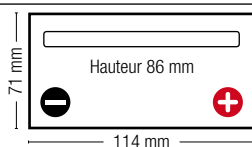

YTX9-BS 12V 8A

229030K (1)

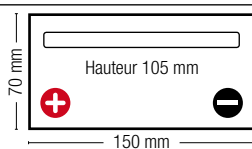

YT7B-BS 12V 6,5A

229035L (1)

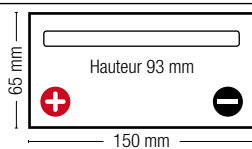

YT9B-BS 12V 8A

229030C

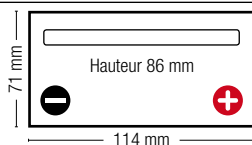

BATTERIE SANS ENTRETIEN
BATTERIA SENZA MANUTENZIONE

YTX12-BS 12V-10A

229035H

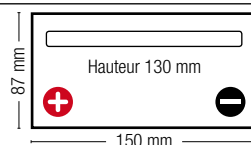

YTX14-BS 14V-12A

229035J

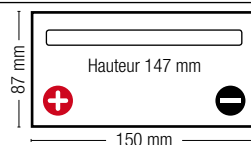

YTX16-BS 12V-8A

229035G

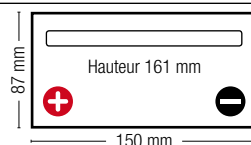

YTZ7S 12V 6A

229035I (1)

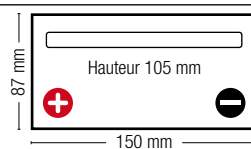

YTZ10S 12V 8,6A

229035N (1)

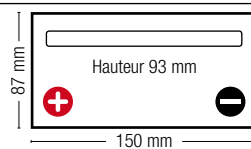

YTZ12S 12V 11A

229035P (1)

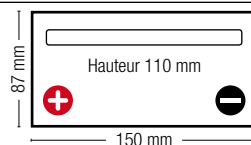



CHARGEUR VOITURE USB
CARICATORE CE DA AUTO USB
540016D 3GS / 4G



CHARGEUR DE BATTERIE
CARICA BATTERIE E MANTENITORE
229100A 12V 1A



CHARGEUR DE BATTERIE
CARICA BATTERIE
229100 12V 0,5A



ACIDE DE BATTERIE
ACIDO BATTERIA
S1054 1L



INDICATEUR DE CHARGE DE BATTERIE
INDICATORE DI CARICA
229100B SCOOTER / MOTO 12-15V

ELETRICITE PARTI ELETTRICHE

BATTERIE BATTERIA

Cyl.	Modèle	Année	YUASA
APRILIA			
50	AF-1 Futura/Europa	87-94	YB4L-B
50	Amico GL/LK/LX/Spor	92-97	YB4L-B
50	AREA 51	00	YB4L-B
50	Classic50	-97	YB4L-B
50	ET		YB4L-B
50	Gulliver AC/LC	-97	YB4L-B
50	Habana, Custom	99	YB4L-B
50	H20	00-	YB4L-B
50	LC		YB4L-B
50	Mc Gulliver	0	YB4L-B
50	Pegaso	00-	YB4L-B
50	Rally AC/LC	-97	YB4L-B
50	Red Rose/Classic	-97	YB4L-B
50	Replica	00-	YB4L-B
50	RS 50/Extrema	-97	YB4L-B
50	RX-50	-93	YB4L-B
50	Scarabeo	-97	YB4L-B
50	Sonic	00-	YB4L-B
50	Sonic, GP	99	YB4L-B
50	SR Ditech	1	YTX5L-BS
50	SR LC/Netscaper	-97	YB4L-B
50	SR Netscaper	00-	YB4L-B
50	SR Replica/Racing	-97	YB4L-B
50	SR Stealth/WWW	-97	YB4L-B
50	SR Urban/Viper		YB4L-B
50	Tuareg Rally/Wind	-97	YB4L-B
100	Scarabeo 100	0	YTX5L-BS
100	Scarabeo 4T	00-	YB9-B
125	AF-1 Futura/Europa	-94	YB9-B
125	AF-1 Project108/Replica	-94	YB9-B
125	AF-1 Sintesi/Sport Pro	-94	YB9-B
125	Classic		YB9-B
125	ETX E-Starter		YB9-B
125	Habana, Custome		YTX9-BS
125	Leonardo	96-01	YB12AL-A
125	Pegaso	-95	YB9-B
125	Red Rose/Classic	-97	YB9-B
125	RS Extrema, RX	-97	YB9-B
125	RS Replica	-93	YB9-B
125	RS 125	95-02	YB9-B
125	Scarabeo 125	99	YB12AL-A
125	SR125	99	YTX7L-BS
125	ST, STX E-Starter		YB9-B
125	Tuareg E-Starter		YB9-B
150	Scabeo 150	99	YB12AL-A
150	SR150	0	YTX7L-BS
200	Scarabeo	00-	YB12AL-A
250	Leonardo	99	YB12AL-A
250	RS Replica		YB4L-B
350	Tuareg Wind	88-94	YB9-B
500	Atlantic		YB14L-A2
1000	ETV	1-Feb	YTX14-BS
1000	RST	1-Feb	YTX12-BS
1000	RSV	98-99	YTX14-BS
1000	RSV Mille, SP, SL	00-02	YTX14-BS
1000	RSV/SL Falco/R/SP	00-02	YB12AL-A
BENELLI			
50	Devil e-starter	94-95	YB4L-B
50	KBX Race	94	YB4L-B
50	K2	97	YB4L-B
50	Pepe	0	YB4L-B
50	Scooty LX/DLX	94	YB4L-B
50	491GT/Sport/Racing	-97	YB4L-B
80	Devil	94-95	YB4L-B
80	KBX	94	YB4L-B
125	Velvet	0	YTX9-BS
150	Velvet	0	YTX9-BS
250	Velvet	0	YTX12-BS

Cyl.	Modèle	Année	YUASA
254	4 Zyl. (Cyl.)		YB9-B
BETAMOTOR			
50	Adventure		YB4L-B
50	Ark Air/ Ark Lc	-97	YB4L-B
50	Chrono	95	YB4L-B
50	Eikon	0	YB4L-B
50	Quadra	-97	YB4L-B
50	Tempo		YB4L-B
125	Eikon	00-	YTX9-BS
150	Eikon	00-	YTX9-BS
BMW			
650	F 650	93-01	YB12AL-A
650	F650CS/GS/ST	98-02	YB12AL-A
CAGIVA			
50	City, Lucky, Explorer	94-97	YTX4L-BS
50	Cucciolo, Mito	98	YB4L-B
50	K3, W4	-98	YB4L-B
125	Crouser, CUCC 125	87-88	YB9-B
125	EV		YB9-B
125	Freccia C9, /C10R, /C12R	87-90	YB9-B
125	K 7, Passing		YB4L-B
125	Mito, -2, Replica, Ev.	-98	YB9-B
125	Mito125,R	94-97	YB9-B
125	N 90	97	YB9-B
125	Planet	98	YB9-B
125	SM125	0	YTX5L-BS
125	Supercity	91-97	YB9-B
125	Tamanaco		YB9-B
125	W 8	ic	YB4L-B
125	Wre 125	0	YTX5L-BS
200	Roadstar	95	YB9-B
650	Raptor/V Raptor	00-02	YTX12-BS
650	V Raptor		YTX9-BS
1000	Raptor/V Raptor	00-02	YTX12-BS
1000	Raptor/V Raptor		YTX9-BS
DEALIM			
125	NS125	97-	YTX7A-BS
125	VC125	96	YB9-B
125	VS125	97	YB9-B
DERBI			
50	Atlantis	99	YB4L-B
50	Atlantis 50 USA		YTX4L-BS
50	Furax	96	YB4L-B
50	Aventura, Furax, Hunter	96-97	YB4L-B
50	Fenix	94	YB4L-B
50	Easy 50	97	YB4L-B
50	GPR		YB4L-B
50	Hunter	97-	YB4L-B
50	Paddock	97-	YB4L-B
50	Predator GP1		YTX4L-BS
50	Predator LC, O2	99	YB4L-B
50	Senda-SM, Senda-R	94-	YB4L-B
50	Sport	97	YB4L-B
50	Vamos	93-	YB4L-B
50	Variant, GS	97	YB4L-B
100	Atlantis 100		YTX9-BS
FANTIC MOTOR			
50	HP 1		YB4L-B
50	Koala	93-97	YB4L-B
50	Oasis		YB4L-B
GILERA			
50	Bullit,Easy moving,runner	-97	YB4L-B
50	DNA		YTX4L-BS

Cyl.	Modèle	Année	YUASA
50	Eaglet	95-97	YB4L-B
50	GSA El.-Starter		YB4L-B
50	Ice		YTX4L-BS
50	Runner/SP	-97	YB4L-B
50	Sioux El.-Starter		YB4L-B
50	Stalker, Storm, Top Rally		YB4L-B
50	Top Rally		YB4L-B
50	Typhoon	-97	YB4L-B
50	X 503		YB4L-B
125	Apache El.-Starter		YB9-B
125	Fast Bike El.-Starter		YB9-B
125	Freestyle El.-Starter		YB9-B
125	KK, KZ E-Starter		YB9-B
125	MX1, MXR El.-Starter		YB9-B
125	Nebraska El.-Starter		YB9-B
125	R1, R1S El.-Starter		YB9-B
125	RTX, RV, RX El.-Starter		YB9-B
125	RTX El.-Starter		YB9-B
125	Runner FX, PD		YB9-B
125	Runner VX 4T		YTX12B-BS
125	RV El.-Starter		YB9-B
125	SP01, SP02 El.-Starter		YB9-B
125	XR1, XR2 El.-Starter		YB9-B
180	Runner SP	99	YTX12-BS
200	Arizona Kick-Starter		YB9-B
200	Fast Bike Kick-Starter		YB9-B
200	RTX, RV, RX El.-Starter		YB9-B
200	RV El.-Starter		YB9-B
HARLEY DAVIDSON			
1000	XLCH Series	70-78	YB7-A
1200	FX Series Kick-Starter	71-78	YB7-A
HERCULES (SACHS)			
50	Gipsy	95	YB4L-B
50	KX5	93-97	YB4L-B
50	Limbo L, M, MA, ML	95-97	YB4L-B
50	Reggagge, Reggagge, Splinter	96-97	YB4L-B
50	Samba, Swing	94-97	YB4L-B
HONDA			
50	C 50SW	94	YB4L-B
50	Fifty		YB4L-B
50	GP Duo		YTX4L-BS
50	Gyro X	00-	YTX7L-BS
50	Gyro Up	00-	YTX7L-BS
50	Gyro Canopy	00-	YTX7L-BS
50	Lead	-1	YB4L-B
50	NH 50 M	82	YB4L-B
50	NH 50 MS	86-98	YB4L-B
50	NP50, M Sky	-97	YB4L-B
50	NU 50M Urban Exp. Delux	82-83	YB4L-B
50	NX 50M Express SR	81-82	YB4L-B
50	PK Wallaroo		YTX4L-BS
50	Press Cub	0	YTX4L-BS
50	PX 50 MS	84	YB4L-B
50	PXR		YB4L-B
50	SA 50LX, N, S, SR	88-98	YTX4L-BS
50	SA Vision		YTX4L-BS
50	SC 01	01-	YTX4L-BS
50	Shadow 50	01-	YTX5L-BS
50	Sky	00-	YTX4L-BS
50	SP Duo		YTX4L-BS
50	SR 50	97-	YTX4L-BS
50	TC 50	00-	YTX7L-BS
50	Vision 50	93-94	YB4L-B
70	C70CAMP	97	YB4L-B
70	C70W	95	YB4L-B
90	C90 CW	95	YB4L-B
90	Shadow 90		YTX5L-BS

ELETRICITE PARTI ELETTRICHE

BATTERIE BATTERIA

Cyl.	Modèle	Année	YUASA
100	NH100-1D	98	YTX5L-BS
100	SH 100	0	YTX5L-BS
100	SJ Bali EX		YTX5L-BS
110	NT110 MV	97	YB4L-B
110	NZ110 MM	93	YB4L-B
125	CA125	95-96	YTX7L-BS
125	CA125 Rebel	95-97	YTX7L-BS
125	CB125 TD	82	YB9-B
125	CD125 T		YB9-B
125	CG125 (E-Stater)		YTX5L-BS
125	CH125	84	YB9-B
125	CH125 Spacy	88-95	YTX9-BS
125	CHA125T	96	YTX9-BS
125	City Fly	98	YTX5L-BS
125	CLR 125	-99	YTX5L-BS
125	CMX		YTX7L-BS
125	CRM		YTX4L-BS
125	NES125	0	YTX7L-BS
125	NSR125 Fc*/R/R2/Raiden	92	YTX5L-BS
125	NSR125 R	97	YTX5L-BS
125	NX125 Transcity	97	YTX7L-BS
125	Shadow 125	99	YTX7L-BS
125	SH 125		YTX7L-BS
125	VT125 Shadow		YTX7L-BS
125	XLR125R	98	YTX7A-BS
150	Foresight 150		YTX7L-BS
150	NES150	0	YTX7L-BS
150	NES150 Z	1	YTX7L-BS
150	SH		YTX7L-BS
150	XLR150	00-	YTX5L-BS
200	CM200 T	88	YTX12-BS
200	CT200	86-89	YB9-B
200	TR200	87	YTX7A-BS
200	TR200	86	YTX9-BS
200	XR200	00-	YTX7L-BS
250	CA250 T	95	YTX7L-BS
250	CA250 TS	97	YTX7L-BS
250	CB250	91-97	YTX7L-BS
250	CB250FV Hornet		YTX7L-BS
250	CBR		YTX7L-BS
250	CB250 R	94-99	YTX7L-BS
250	CBX250, RS-YA	85-87	YTX9-BS
250	CD250 U	85-89	YTX9-BS
250	CH250	87-89	YTX12-BS
250	CJ250 T		YB9-B
250	CL250 S	82	YB9-B
250	CM250 C	82-85	YB9-B
250	CM250, Custom	82-83	YB9-B
250	CMX250 C Rebel	85-87	YB9L-B
250	CMX250 C Rebel	96-99	YTX7L-BS
250	CMX250 C3	01-	YTX7L-BS
250	CN250 Helix	86-98	YTX12-BS
250	FES250V Foresight	98-00	YTX12-BS
250	FTR		YTX5L-BS
250	NX250	88-96	YTX7L-BS
250	SL230		YTX5L-BS
250	VT250	90-95	YTX7L-BS
250	VT250CS	-97	YTX7L-BS
250	VT250C V-TWIN MAGNA		YTX7L-BS
250	VTR250 Interceptor	88-90	YB9-B
250	XR250		YTX5L-BS
400	CB400F (CBI)	89-90	YTX9-BS
400	CBR400RRR	86-89	YTX9-BS
400	CBR400RRR	92-94	YTX7L-BS
400	NS400 R/Raiden		YTX5L-BS
400	NV400 C	95	YTX9-BS
400	VFR400Re*	90-91	YTX7A-BS
450	CB450N	85	YB12AL-A
500	CB500	94-02	YTX9-BS
500	CB500S	98-99	YTX9-BS

Cyl.	Modèle	Année	YUASA
500	CBR500F	87-89	YTX9-BS
500	NX500	88-95	YTX9-BS
550	CB550	83-84	YB12AL-A
550	CB550SC	83-85	YB12AL-A
600	CB600 F	98	YTX7L-BS
600	CB600 SF	98-01	YTX7L-BS
600	CBR600 F, Fc*, Fc*, SE	95-99	YTX9-BS
600	CBR600F/SP	87-00	YTX9-BS
600	CBX600E	83	YB12AL-A
600	Harnet 600	98	YTX7L-BS
600	NTV600	88-92	YTX9-BS
600	NV600C	89-94	YTX9-BS
600	Shadow 600		YTX9-BS
600	VT600C Shadow	88-99	YTX9-BS
600	VT600C	88-97	YTX9-BS
650	CB650 SC Nighthawk	83-85	YB12AL-A
650	CBX650E Nighthawk	82-83	YB12AL-A
650	Deauville 650		YTX9-BS
650	FX650	-1	YTX9-BS
650	NT650 Hawk GT	88-90	YTX9-BS
650	NTV650 Revere	88-97	YTX9-BS
650	NX650 Dominator	88-97	YTX9-BS
650	XR650L	93-99	YTX9-BS
750	CR750 45		YTX9-BS
750	NR750	92	YTX12-BS
750	RVF750R	94-95	YTX9-BS
750	VF750C	95-97	YTX12-BS
750	VF750C Magna	93-94	YTX9-BS
750	VF750S Sabre	82-83	YTX12-BS
750	VFR750F	90-97	YTX12-BS
750	VFR750R	88-90	YTX9-BS
800	PC800 Pacific Coast	89-98	YTX12-BS
800	VFR800FI	98-01	YTX12-BS
900	CBR900RR FireBlade	92-99	YTX9-BS
1000	CB1000F	93-96	YTX12-BS
1000	CB1000FT	93-96	YTX12-BS
1000	VTR1000 F Firestorm	97-00	YTX12-BS
1100	CB1100SF	00-01	YTX12-BS
1100	CBR1100 XX Blackbird	97-00	YTX12-BS

ITALJET			
50	Bazooka, 2		YB4L-B
50	Cruise		YB4L-B
50	Dragster	97	YB4L-B
50	Formula	95-	YB4L-B
50	Pista		YB4L-B
50	Reporter		YB4L-B
50	Scoop		YB4L-B
50	Torpedo	97-	YB4L-B
50	Velocifero	95-	YB4L-B
125	Millenium		YTX7A-BS
125	Torpedo	99	YB9-B
150	Millenium		YTX7A-BS
150	Torpedo		YB9-B

KAWASAKI			
125	BN125 A1-A2 Eliminator	98-02	YB9-B
125	KMX125 A1-A8, A11	86-02	YB4L-B
125	KMX125 B1-B9	91-	YB4L-B
200	KMX200 A2-A5	-97	YB4L-B
250	D-TRACKER (LXE)	02-	YTX7L-BS
250	Estrella - BJ250 A2-A3 C2-C3	92-	YTX9-BS
250	EL250 A	95	YTX7L-BS
250	GPZ250R EX250 F9-F13	95-	YTX7L-BS
250	GPZ250R EX250 H5-H9	95-	YTX7L-BS
250	KL250 D2-D16		YB4L-B
250	KL250G, H Super Sherpa	-97	YTX7L-BS
250	KLE250 Anhelio (LE250A)	-97	YTX7L-BS
250	KLX250 ES G1/G2	94-95	YTX7L-BS
250	KR250 B, C, KR, 1S	-92	YB4L-B

Cyl.	Modèle	Année	YUASA
250	ZR250 A, B Badius	91-	YTX7L-BS
250	ZZ-R (EX250H)	99-02	YTX7L-BS
250	Z50TR (BJ250F)	02-	YTX7L-BS
400	KLE400 (LE400A)	91-	YTX12-BS
400	VN400A, C Vulcan	95-	YTX12-BS
400	ZR400C, G Zephyr	93-	YTX12-BS
400	ZR400D Xanthus	92-	YTX9-BS
400	ZRX, -cJ (ZR400E,F,D)	95-	YTX9-BS
400	ZXR400, R (ZX400M, L)	92-02	YTX9-BS
400	ZZ-R400 (ZX400N)	93-	YTX12-BS
500	ER525KW	97-01	YTX12-BS
500	ER537KW	97-01	YTX12-BS
550	VLE500A	91	YTX12-BS
550	ZR550B Zephyr	94-97	YTX12-BS
550	ZZ-R500 Ninja (ZX500D)	-98	YTX12-BS
600	KL600A KLR	84-92	YB4L-B
600	ZX600E ZZR Ninja	93-02	YTX12-BS
600	ZX600F ZX-6R Ninja	95-98	YTX12-BS
600	ZX600 G/H/R	95-97	YTX12-BS
600	ZX600 G/H/R	98-02	YTX9-BS
636	ZX-6R (ZX636A)	02-	YTX9-BS
650	KLX650 (LX650C)	93-95	YTX9-BS

KL-SHELUNG			
50	Club		YTX4L-BS
50	Racer		YTX4L-BS

KTM			
50	Kross		YB4L-B
250	EXC Racing	00-	YTX5L-BS
400	LC4	98	YTX9-BS
400	LC4-E	97	YTX9-BS
400	LS-E	97	YTX9-BS
450	EXC Racing	00-	YTX5L-BS
450	MXC Racing	00-	YTX5L-BS
500	500K4, LC		YB9-B
525	EXC Racing	00-	YTX5L-BS
525	MXC Racing	00-	YTX5L-BS
620	Adventure	97	YTX9-BS
620	Duke	96-97	YTX9-BS
620	Duke E	96-97	YTX9-BS
620	LC4 Supercomp.	98	YTX9-BS
620	LS-E	97	YTX9-BS
640	Adventure R	-99	YTX9-BS
640	Duke	-99	YTX9-BS
640	LC4-E, LC4 Supermoto	-99	YTX9-BS

KYMCO			
50	Calypso 50, Cobra, Cross	99	YTX5L-BS
50	CX/CX Super	00-	YTX4L-BS
50	CX50, -Curio, -Super	95-97	YTX4L-BS
50	Dink 50/LC	99	YTX5L-BS
50	Dj 50, Djw 50, Djx 50	98-	YTX4L-BS
50	Djy 50		YTX4L-BS
50	Filly 50	99	YTX5L-BS
50	Fever ZX	0	YTX5L-BS
50	Heroism	95-97	YTX4L-BS
50	K12	96-97	YTX4L-BS
50	KB	97	YTX4L-BS
50	People	00-	YTX5L-BS
50	Racer, Looping, People	99	YTX5L-BS
50	Sniper/Sniper DD	00-	YTX4L-BS
50	Spacer	99	YTX5L-BS
50	Super 9	99	YTX5L-BS
50	Top Boy	97	YTX5L-BS
80	Filly 80	99	YTX5L-BS
100	AS100	99	YTX5L-BS
100	KB	97	YTX5L-BS
100	Top Boy	97	YTX7A-BS
125	B & W 125	99	YTX9-BS

* Adaptable
* Adattabile

Les références du constructeur sont seulement indicatives et n'impliquent pas que les pièces de rechange viennent du constructeur.
I codici di riferimento originali sono indicativi e non implicano che i ricambi provengano necessariamente dalla stessa fabbrica del costruttore.

ELETRICITE PARTI ELETTRICHE

BATTERIE BATTERIA

Cyl.	Modèle	Année	YUASA
125	Calypso 125	99	YTX9-BS
125	Dink/LX	97	YTX9-BS
125	Fox Hunt	96	YTX7A-BS
125	Heroism	95-96	YTX9-BS
125	Jockey 125	99	YTX7A-BS
125	People 125	0	YTX7A-BS
125	Spacer	99	YTX9-BS
125	Vivio		YTX9-BS
125	Zing	99	YTX7A-BS
150	B&W 150		YTX9-BS
150	Dink/LX	97	YTX9-BS
150	Fox Hunt	96	YTX7A-BS
150	Heroism	96	YTX9-BS
150	People 150		YTX7A-BS
150	Spacer	99	YTX9-BS
150	Vivio		YTX9-BS
150	Zing	99	YTX7A-BS
250	B&W 250		YTX12-BS
250	Dink 250		YTX12-BS
250	Super-9	0	YTX12-BS

LAVERDA			
750	Formula		YB4L-B

MALAGUTTI			
50	Centro, -SL	94-	YB4L-B
50	Colors		YB4L-B
50	CR1	96-	YB4L-B
50	Crosser/EL	98	YB4L-B
50	Dune ES	89	YB4L-B
50	Evolution		YB4L-B
50	F10, F12/F12LC		YB4L-B
50	F12LC Twin Disk		YB4L-B
50	F15/F15 Twin Disk		YB4L-B
50	Fifty Top Fire Fox F15	91	YB4L-B
50	F.10		YB4L-B
50	Mistral		YB4L-B
50	New Dribbling		YB4L-B
50	Phantom F.12	94-	YB4L-B
50	RST		YB4L-B
50	Top		YB4L-B
50	Yesterday, EURO	99	YB4L-B
100	F12		YTX5L-BS
125	Ciak		YB9-B
125	F18		YB9-B
125	Madison	0	YB9-B
150	Ciak		YB9-B
150	F18		YB9-B
150	Madison		YB9-B
180	Madison		YB9-B
250	Madison	0	YB9-B
400	Madison		YB9-B

MBK			
50	Active		YB4L-B
50	Booster	93-96	YB4L-B
50	Booster NG	96-97	YB4L-B
50	Booster Road	95	YB4L-B
50	Booster Rocket	96-97	YB4L-B
50	Booster Spirit	-99	YB4L-B
50	Booster Track	-99	YB4L-B
50	CTS/SS		YB4L-B
50	Equalis	-99	YB4L-B
50	Evolis	93-97	YB4L-B
50	Fizz	95-96	YB4L-B
50	Forte	96-97	YB4L-B
50	Nitro	-99	YB4L-B
50	Ovetto 2 tps	99-10	YB4L-B
50	Sorriso/New Sorriso		YB4L-B
50	Target		YB4L-B

Cyl.	Modèle	Année	YUASA
80	Evolis	95-96	YB4L-B
100	Booster		YTX5L-BS
100	Nitro		YTX4L-BS
100	Ovetto		YTX4L-BS
125	Doodo		YB7L-B2
125	Flame	95-97	YTX7A-BS
125	Flame R	-98	YTX7A-BS
125	Skyliner 125	-99	YB7L-B2
125	XC Flame/Flame R		YTX7A-BS
150	Skyliner		YB7L-B2
150	Vertex		YTX7A-BS

MOTRON			
50	Compact Racing RZ1		YB4L-B
50	invader		YB4L-B
50	spike		YB4L-B
50	Sting		YB4L-B
50	Sting		YB4L-B
50	Syncro		YB4L-B
50	Thunder		YB4L-B
50	XLE		YB4L-B

PEUGEOT			
25	FOX LA	95-97	YB4L-B
50	Buxy	95-97	YB4L-B
50	Buxy RS	96-97	YB4L-B
50	Elyseo	98	YB4L-B
50	FOX Lux	95-97	YB4L-B
50	Looxor	01-	YB4L-B
50	Rapido/Rapido 3	01-	YB4L-B
50	SCLI Metropolis	01-	YB4L-B
50	Speedake	01-	YB4L-B
50	Speedfight/LC	97-99	YB4L-B
50	Speedfight 2	00-	YB4L-B
50	Squab	96-97	YB4L-B
50	ST	01-	YB4L-B
50	SV/SV Geo	93-97	YB4L-B
50	SV Junior	93-96	YB4L-B
50	SV Blue Star	97	YB4L-B
50	Trekker Road/Off Road	99	YB4L-B
50	Vivacity	99	YB4L-B
50	X-Fight		YB4L-B
50	Zenith	95-96	YB4L-B
100	Elyseo	98	YB7-A
100	Elyseo	01-	YB7L-B2
100	Looxor	01-	YTX5L-BS
100	Speedfight	01-	YTX5L-BS
100	Speedfight	98	YTX5L-BS
100	Trekker	98	YTX5L-BS
100	Trekker	01-	YTX5L-BS
100	Vivacity	99	YTX5L-BS
100	Vivacity	01-	YTX5L-BS
100	X-Fight	01-	YTX5L-BS
100	Zenith	01-	YB4L-B
105	Ciclotomote (E-Starter)	01-	YB4L-B
125	Elyseo		YB7-A
150	Elyseo	98	YB7-A
250	ST/SV	01-	YTX12-BS

PGO			
50	Big Max	95-96	YB4L-B
50	Star-Starç]	93-96	YB4L-B

PIAGGIO			
25	Free, FL	94-98	YB4L-B
25	Velofax	-98	YB4L-B
25	Zip	94-98	YB4L-B
50	Diesis		YB4L-B
50	Free, FL, FL0†	94-99	YB4L-B
50	Liberty	-99	YB4L-B
50	Liberty 4T		YB9-B

Cyl.	Modèle	Année	YUASA
50	NRG Extreme	95-98	YB4L-B
50	NRG Extreme	99	YTX4L-BS
50	NTT		YB4L-B
50	Quartz	93-98	YB4L-B
50	Scatto		YB4L-B
50	Sfera/FL	93-98	YB4L-B
50	Storm	95-96	YB7-A
50	Tiphon	94-99	YB4L-B
50	Velofax	-98	YB4L-B
50	Vespa ET2, Injection	98-	YB4L-B
50	Vespa PK FL/FL2		YB7-A
50	Vespa PK/HP		YB7-A
50	Vespa PK N, S		YB7-A
50	Vespa PK Rush		YB7-A
50	Zip 4T	00-	YTX9-BS
50	Zip cat. 2T	00-	YTX4L-BS
50	Zip FR/ RST/ SP		YB4L-B
50	Zip/Zip Fast Rider		YB4L-B
80	PX80 E		YB9-B
80	PX80 E Lusso	90-96	YB7-A
80	PK80 S, XL		YB7-A
80	Sfera	93-95	YB7-A
125	Cosa, CL, FL, X	-95	YB7-A
125	Excutive	00-	YB9-B
125	Hexagon, Hexagon LX, RST	-99	YB9-B
125	Hexagon LX4	00-	YTX12-BS
125	Liberty	99	YB9-B
125	Sfera/FL	96-98	YB7-A
125	Skipper		YB7-A
125	Skipper LX/ST 4T	99	YB9-B
125	SKR	94-98	YB7-A
125	ST4 Leader	00-	YTX9-BS
125	Superhexagon GTX	00-	YTX12-BS
125	Tiphon	96-99	YB7-A
125	Vespa ET4	96-00	YB9-B
125	Vespa ETS		YB7-A
125	Vespa PK-S, -FL, -XL		YB7-A
125	Vespa PX E	-98	YB9-B
125	Vespa PX S	-98	YB7-A
125	Vespa T5		YB7-A
125	Zip 4T	00-	YTX9-BS
150	Cosa CL, X		YB7-A
150	Excutive		YB9-B
150	Hexagon	95-97	YB9-B
150	Liverty LE150	0	YB9-B
150	Skipper		YB7-A
150	Skipper LX/ST 4T	-99	YB9-B
150	Vespa ET4	99-	YTX9-BS
150	Vespa PX X		YB7-A
180	Hexagon LXT	00-	YTX12-BS
180	Superhexagon GTX	01-	YTX12-BS
200	Cosa	-96	YB9-B
200	Vespa P E		YB7-A
250	Hexagon	98	YB9-B
250	Hexagon GT	00-	YTX12-BS
250	Superhexagon GTX	01-	YTX12-BS
250	X9	01-	YTX12-BS

PUCH			
50	Lido SL		YB4L-B
125	Lido CD		YB7-A

RIZZATO			
50	Byte AT10		YB4L-B
50	Carosello		YB4L-B
50	Hacker AT12, LC/Racing		YB4L-B

SANYANG			
125	Duke	95-96	YTX7A-BS
125	Husky	96-99	YTX7L-BS

ELECTRICITE PARTI ELETTRICHE BATTERIE BATTERIA

Cyl.	Modèle	Année	YUASA
125	Super Duke	96-99	YTX7L-BS
150	Attila	99	YTX7A-BS
150	Super Duck	99	YTX7A-BS

SUZUKI			
Cyl.	Modèle	Année	YUASA
50	CP50	85-95	YTX4L-BS
50	RG50	91	YB4L-B
50	TS50W, XA, XK	91	YB4L-B
50	Tune 50	97-	YTX4L-BS
50	Zillion		YTX4L-BS
50	ZZ50	97	YTX4L-BS
80	FB80D	95	YTX5L-BS
80	RG80, C	85-95	YB4L-B
80	TS80X	84-87	YB4L-B
100	AG100	91-95	YTX5L-BS
100	AG100	-1	YTX5L-BS
100	AH100 Adress	95-96	YTX5L-BS
110	UG110 Hokuto	0	YTX5L-BS
110	Hokuto		YTX5L-BS
125	AN125(Vecstar)	95-02	YTX7A-BS
125	Burgman		YTX9-BS
125	DN125	91	YB7-A
125	DR125, D, S		YTX4L-BS
125	DR125SE	94-97	YTX7A-BS
125	DZ125	-2	YTX7L-BS
125	Epicuro		YTX7A-BS
125	GN125, E, U	82-98	YB7-A
125	GS125ES	91-92	YB7-A
125	GS125S	-99	YB7-A
125	GZ125 Marauder	99	YTX7L-BS
125	PG125 Gamma		YTX5L-BS
125	RG125, F	92-95	YTX7L-BS
125	RW125 SE, R	94	YTX7L-BS
125	RV125 Tracker	-2	YTX7L-BS
125	TS125R, SZ	91-92	YTX4L-BS
125	TS125X	92	YB4L-B
125	VL125 Intruder LC	-2	YTX7L-BS
150	AN150	-2	YTX7A-BS
150	Burgman		YTX9-BS
150	UC150 Epicuro	99	YTX7A-BS
200	DR200SE	96-02	YTX7L-BS
200	GT200N, EN	79	YB7-A
200	RV200	-2	YTX7L-BS
200	SP200	86-88	YB4L-B
250	AN250 Sky Wave	98	YTX7A-BS
250	AN250 Burgman	99	YTX7A-BS
250	DR250	-1	YTX5L-BS
250	DR250S (Europe)	90-95	YTX7L-BS
250	DR250S	-87	YB4L-B
250	GSF250	95	YTX7A-BS
250	GXS250F, S	91-95	YTX7A-BS
250	GZ250 Marauder	99-01	YTX7L-BS
250	SP250	92	YB4L-B
250	TS250X	-94	YB4L-B
250	VL250	-2	YTX7L-BS
350	DR350SE	94-99	YTX7L-BS
380	GT380 Sebring	72-77	YTX9-BS
400	AN400 Burgman	99-02	YTX9-BS
400	GS400, E	91	YTX9-BS
400	GS400X	91-95	YTX9-BS
400	GSF400	91-93	YTX9-BS
400	GSF400M		YTX9-BS
400	GXS-R400R, RF	91-95	YTX9-BS
400	GXS400FS Inazuma	-2	YTX7A-BS
400	SV400 S	-2	YTX9-BS
400	VZ400	-2	YTX7A-BS
500	DR500S	92	YB4L-B
500	SP500	92	YB4L-B
600	GSF600, S, SU, U, Ue]	95-02	YTX9-BS
600	GXS600F Katana	98-02	YTX9-BS

Cyl.	Modèle	Année	YUASA
600	GXS-R 600 V, W	-2	YTX9-BS
600	RF600R, RU	93-97	YTX9-BS
600	VS600GLS		YTX9-BS
650	DR650RE, REU	94-95	YTX12-BS
650	DR650SE, SEU	91-98	YTX9-BS
650	DR650SES	95-	YTX12-BS
650	XF650 Freewind	97-02	YTX9-BS
750	GXS750, F	98-99	YTX9-BS
750	GXS750F Katana	98-02	YTX9-BS
750	GXS-R750	96-99	YTX9-BS
750	GXS-R750, W	92-93	YTX12-BS
750	GXS-R750, W	94-95	YTX9-BS
800	VL800 Intruder	1-févr	YTX12-BS
800	VZ800 Marauder	97-99	YTX12-BS
900	RF900R	94-97	YTX9-BS
1000	GXS-R1000	1-févr	YTX12-BS
1000	TL1000S V	97-02	YTX12-BS
1100	GXS-R1100W	93-97	YTX12-BS
1200	Bandit1200S	-2	YTX12-BS
1200	GS1200SS	-2	YTX12-BS
1200	GSF1200, S, SA Bandit	96-02	YTX12-BS
1200	GXS1200	99-00	YTX12-BS

TGB/WINKING			
Cyl.	Modèle	Année	YUASA
50	AS25 Bunny	96	YB4L-B
50	AS50 X Bunny	94-95	YB4L-B
50	AS50 X Kurier	95	YB4L-B
50	AT50 Bunny	93	YB4L-B
50	AT50 Bunny Gespann	93-94	YB4L-B

TRIUMPH			
Cyl.	Modèle	Année	YUASA
800	Bonneville	1-Feb	YTX12-BS

YAMAHA			
Cyl.	Modèle	Année	YUASA
50	Aero X	98	YB4L-B
50	Aerox R, Max		YB4L-B
50	Axis		YTX4L-BS
50	Beluga		YB4L-B
50	Breeze		YB4L-B
50	BW'S Bump, Spy	99	YB4L-B
50	BW'S Original	0	YB4L-B
50	CE50S Riva	86-87	YB4L-B
50	CG50	88-91	YB4L-B
50	CR50, Z	89-93	YB4L-B
50	CTS/SS		YB4L-B
50	CW50, RS, RSX BW°¶js	91-97	YB4L-B
50	CW50 Zuma	89-90	YB4L-B
50	CW50 Zuma ii	97-01	YB4L-B
50	CW50RSP NG	96-97	YB4L-B
50	NEOS 2 tps	99-10	YB4L-B
50	NG		YB4L-B
50	Original		YB4L-B
50	SH50, E, D, M Riva	87-94	YB4L-B
50	SH50 Riva Razz	87-01	YB4L-B
50	Slider	0	YB4L-B
50	Spy		YB4L-B
50	STS/SS		YB4L-B
50	YE50 Zest	93-97	YB4L-B
50	YM50 Breeze	95-96	YB4L-B
50	YW50A Zuma	2-mars	YTX5L-BS
65	CW65	94	YB4L-B
80	YE80 Zesyt	94-96	YB4L-B
90	BW'S 100	99	YTX5L-BS
90	CR90	91	YB4L-B
100	Aerox 100	0	YTX4L-BS
100	BBW'S 100	99	YTX5L-BS
100	BW'S 100	0	YTX4L-BS
100	YT100 (Taiwan)	99	YTX5L-BS
125	TDR125, R	93-	YTX5L-BS
125	Teo's		YB7L-B2

Cyl.	Modèle	Année	YUASA
125	XC125R, T, TR Cygnus	93-	YTX7A-BS
125	YP125R Majesky	99-00	YB7L-B2
150	XC150 Fly One R	98	YTX7A-BS
225	XT225, E, EC, F, FG, G, GC	93-	YTX7L-BS
225	XT225 Serow	92-00	YTX7L-BS
250	SRV250, G	93-	YTX7A-BS
250	WR250F	3	YTX5L-BS
250	XS250	77-80	YB12A-A
400	FZR400RR, RRSP	92-	YTX9-BS
400	XV400	95	YB12AL-A
450	WR450F	3	YTX5L-BS
500	XT500E	93-	YTX9-BS
600	FZR600	89-93	YB12AL-A
600	FZR600R	94-95	YTX12-BS
600	TT600E	94	YTX9-BS
600	XJ600N	94-99	YTX9-BS
600	XJ600S Diversion	92-02	YTX9-BS
600	XT600E, EH, EN	91-02	YTX9-BS
600	YZF600FGC, RG	95	YTX12-BS
600	YZF600R Thunder Cat	96-03	YTX12-BS
660	SZR660	96-98	YTX9-BS
660	XTZ660 Tenere	91-97	YTX9-BS
750	FZR750	91-	YTX9-BS
750	YZF750R, SP	93-97	YTX12-BS
850	TDM850, N	91-95	YTX12-BS
850	TRX850	96-99	YTX12-BS

* Adaptable
* Adattabile

Les références du constructeur sont seulement indicatives et n'impliquent pas que les pièces de rechange viennent du constructeur.
I codici di riferimento originali sono indicativi e non implicano che i ricambi provengano necessariamente dalla stessa fabbrica del costruttore.



NGK STANDARD

Avantages des bougies NGK :

- Puissance d'étincelle accrue
- Démarrage à froid amélioré
- Meilleures performances moteur
- Combustion parfaite
- Emissions polluantes réduites
- Gamme thermique élargie

NGK STANDARD

S427	B4	S611	BP6HS
S608	B6S	S602	BPM6A
S8960	B9S	S702	BPM7
S909	B9HCS	S703	BPM7A
S508	B5HS	186221	BPMR6A
185990	B6HS	S713	BPMR7A
186000	B7HS	S501	BPR5ES
186100	B8HS	S613	BPR6ES
186200	B9HS	S712	BPR7ES
186201	B10HS	186400	BPR6HS
S809	B8HV	S8606	BPR6HSA
S111430	B6HVX	186401	BR6HSA
S5566	B7HVX	186403	BR8HSA
S410	B4ES	S714	BPR7HS
186211	B7ES	S848	BPR8HS
186212	B8ES	S404	BPR4HS
186213	B9ES	186418	C7HSA
186214	B10ES	186426	CR7EKB
S913	B9EG	186421C	CR8EKB
S8338	B11EG	S806	D8EA
S810	B8EV	S8888	D8HA/HS
S90129	B8EVX	S9804	DPR9EA9
S80605	BR6S	S93308	JR9C
S616	BR6HS	S625	CM6
186401A	BR6HS-10	186418C	CR5EH-9
186410	BR7HS	S5946	CR6HSA
186410A	BR7HS-10	186418A	CR7HSA
186411	BR8HS	186419	CR8HSA
186412	BR9HS	186420	CR7E
S868	BR6ES	186420A	CR8E
186415	BR7ES	186421	CR7EB
186416	BR8ES	186421A	CR8EB
186416A	BR8ES-?	186421B	CR9EB
186417	BR9ES	S5947	CPR8E
186417A	BR10ES	186424A	CPR8EA-9
S8010	BR8ECS	186424	CPR9EA-9
S403	B4H	S8506	CR9E
S252	B2LM	S84548	CR9EK
S8402	B4LM	186425	CR8EH-9
S604	BM6A	S8805	DR8EA
S601	BM6F	S8802	DR8ES
S706	BM7F	186418E	DPR6EA-9
S704	BM7A	S8804	DPR7EA9
S614	BMR6A	186422	DPR8EA9

NGK RACING

Bougies d'allumage de compétition NGK développées spécialement pour les sports mécaniques.

La bougie d'allumage racing destinée à la compétition doit être capable de supporter les conditions les plus extrêmes :

- Accélération et décélération puissantes et répétées
- Fonctionnement intensif du moteur à haut régime

Les conditions extrêmes dans la chambre de combustion telles que les variations de température, la pression, les vibrations et les turbulences ne peuvent pas être supportées par une bougie dite « standard »

NGK RACING

186423	B9EGV
186423A	B10EGV



NGK RACING

186410C	SILMAR8C9 (HONDA 125 FORZA 2015)
OEM : 31917K40F01	

NGK IRIDIUM

Les bougies d'allumage Iridium NGK représentent la solution technique la plus aboutie du marché. Elles possèdent une pointe fine en Iridium sur l'électrode centrale, soudée au laser par un procédé spécial.

L'Iridium est un métal précieux et l'un des matériaux les plus solides au monde. Il commence à fondre à partir de 2450°C et résiste particulièrement bien à l'érosion électrique créée par l'étincelle. La durée de vie d'une bougie Iridium est 2 fois supérieure à celle d'une bougie standard.

Par ailleurs, l'utilisation de l'Iridium permet de :

- Réduire l'électrode centrale à une pointe très fine de 0,6 mm de diamètre
- Diminuer la tension nécessaire à l'allumage
- Améliorer l'inflammation dans la chambre de combustion.

NGK IRIDIUM

186418B	CR7HIX
186300	CR8HIX
S617	BR6HIX
S717	BR7HIX
S8171	BR8HIX
S8181	BR8EIX
S8191	BR9EIX
186217A	BR9HIX
S81111	BR10EIX
186301	BR10HIX

ELECTRICITE PARTI ELETTRICHE SIGNIFICAZIONE DES REFERENCES SIGNIFICANCE REFERENCES

	Ø	CLÉ 6 PANS	PAS DE VIS
A	18 mm	25,4 mm	1,50 mm
B	14 mm	20,8 mm	1,25 mm
C	10 mm	16,0 mm	1,00 mm
D	12 mm	18,0 mm	1,25 mm
E	8 mm	13,0 mm	1,00 mm
G	1/2 pouce	23,8 mm	1,25 mm
J	12 mm	18,0 mm	1,00 mm
AB	18 mm	20,8 mm	1,50 mm
BC	14 mm	16,0 mm	1,25 mm
BK	14 mm	16,0 mm	1,25 mm
(BCP aux normes ISO)			
DC	12 mm	16,0 mm	1,25 mm
Référence BM_A & BPM_A			
	14 mm	19,0 mm	1,25 mm
Référence CM-6			
	10 mm	14,0 mm	1,00 mm

CONSTRUCTION-CARACTÉRISTIQUES	
L	Isolant court
M	Type compact
P	Isolant proéminent
R	Résistance intégrée
U	Décharge superficielle ou semi-superficielle
Z	Inductance intégrée

LONGUEUR FILETAGE	
E	19,0 mm
H	12,7 mm
L	11,2 mm
EH	Semi-filetage Culot = 19 mm Filet = 12,7 mm
Type BM A, B_LM : 9,5 mm	
Type CMR_A : 9,5 mm	
F	Siège conique
Type A_F :	10,9 mm
Type B_F :	11,2 mm
Type B_EF :	17,5 mm
Type BM_F :	7,8 mm
Type BPM_F :	7,8 mm
Type A_ :	12,0 mm
Type B_/BM_ :	9,5 mm
Type CM_ :	8,5 mm
Type G_ :	22,5 mm

B C P R 6 E S — 11

TYPE	
I	Électrode Iridium
L	Longueur de filetage 26,5 mm
P	Électrode Platine
Z	Isolant surprojeté
Ces lettres peuvent être combinées	
Ex : IZ, LZ, PL, PLZ, etc...	

INDICE THERMIQUE	
2	Chaud
4	
5	
6	
7	
8	
85	
9	
95	
10	
105	
11	
12	Froid

ÉCARTEMENT	
8	0,80 mm
9	0,90 mm
10	1,00 mm
11	1,10 mm
13	1,30 mm
14	1,40 mm
15	1,50 mm

DESSIN DE L'ÉCLATEUR	
A, B, D, E	Dessin spécial
CM/CS	Électrode de masse oblique
F/FS	Siège conique
G	Électrode fine en alliage de nickel
GV	Électrode centrale en Iridium Forme spéciale
I	Électrode centrale en Iridium
IX	Gamme Iridium IX
J	2 électrodes de masse
K	2 électrodes de masse à effet semi-surfacique
KC	2 électrodes de masse
-L	Demi indice thermique plus chaud
-LM	Type compact longueur d'isolant 14,5 mm
-LPG	Gamme GPL
M	3 électrodes de masse pour moteur rotatif mazda
-N	Électrode de masse spéciale
P	Électrode centrale en Platine
Q	4 électrodes de masse
S	Électrode centrale en cuivre
SZ	Électrode centrale en cuivre, diamètre 2,9 mm
T	3 électrodes de masse
U	Type à décharge semi-surfacique
V	Électrode centrale Or-Palladium
VX	Électrode centrale en Platine
W	Électrode tungstène
X	Éclateur interne
Y	Gorge en 'V'-Proéminence sup. de 1 mm

P F R 6 A — 11 A

DIMENSION DU CULOT			
Ø	Longueur	Clé 6 pans	Pas de vis
F	14 mm	19,0 mm	16,0 mm
G	14 mm	19,0 mm	20,8 mm
J	12 mm	19,0 mm	18,0 mm
K	12 mm	19,0 mm	16,0 mm
KA	12 mm	26,5 mm	14,0 mm
LF	14 mm	26,5 mm	16,0 mm
M	10 mm	19,0 mm	16,0 mm
MA	10 mm	19,0 mm	14,0 mm
T	14 mm	17,5 mm	16,0 mm
Exception PTR5A, TR5A, TR5B			
	14 mm	25,0 mm	16,0 mm
U	14 mm	11,2 mm	16,0 mm
w	18 mm	10,9 mm	20,8 mm
X	14 mm	9,5 mm	20,8 mm
Y	14 mm	11,2 mm	16,0 mm
Z	14 mm	19,0 mm	16,0 mm

TYPE DE CONSTRUCTION	
R	Résistance

FAMILLES DE CONCEPTION	
a	Type a
b	Type b
c	Type c
...	...

CARACTÉRISTIQUES PARTICULIÈRES	
A	sans joint
B	spécial
C	spécial
D	spécial
...	...

* Adattabile
* Adattabile

Les références du constructeur sont seulement indicatives et n'impliquent pas que les pièces de rechange viennent du constructeur.
I codici di riferimento originali sono indicativi e non implicano che i ricambi provengano necessariamente dalla stessa fabbrica del costruttore.

IRIDIUM IX



Sensations extrêmes



Vodafone McLaren Mercedes F1 Team

sur piste...



sur mer...

sur neige...



sur terre...



SPECIFICATION

NGK ORIGIN	IRIDIUM IX
B6HS	BR6HIX
B7ES	BR7EIX
B7HS	BR7HIX
B8ES	BR8EIX
B8HS	BR8HIX
B9ES	BR9EIX
B9HS	BR9HIX
B10ES	BR10EIX
B10HS	BR10HIX
BP5ES	BPR5EIX
BP6ES	BPR6EIX
BP6HS	BPR6HIX
BPR7HS	BPR7HIX
BR6HS	BR6HIX
BR7HS	BR7HIX
BR8ES	BR8EIX
BR8HS	BR8HIX
BR9ES	BR9EIX
BR9HS	BR9HIX
CR7E	CR7EIX
CR7EB	CR7EIX
CR7HSA	CR7HIX
CR8E	CR8EIX
CR8EB	CR8EIX
CR8EH-9	CR8EHIX-9
CR9E	CR9EIX
DPR7EA-9	DPR7EIX-9
DPR8EA-9	DPR8EIX-9
DR8EA	DR8EIX



ELECTRICITE PARTI ELETTRICHE

CAPUCHON ET FIL DE BOUGIE PIPETTA & FILO CANDELA

NGK



**CAPUCHON DE BOUGIE
PIPETTA CANDELA**

186990 NGK LB 10E (1)



**CAPUCHON DE BOUGIE
PIPETTA CANDELA**

186991 NGK LB 05E
S1151 NGK LB 05F



**CAPUCHON DE BOUGIE
PIPETTA CANDELA**

186991A NGK VB5E



**CAPUCHON DE BOUGIE
PIPETTA CANDELA**

186991D NGK VB05F



**CAPUCHON DE BOUGIE
PIPETTA CANDELA**

186991B RACING LB05 EMH



**FIL DE BOUGIE RACING
FILO CANDELA RACING**

187002 90° (1)



**FIL DE BOUGIE RACING
FILO CANDELA RACING**

187002B DROIT STRAIGHT

TNT
Original



**CAPUCHON DE BOUGIE SCOOTER
PIPETTA CANDELA SCOOTER**

186989



**CAPUCHON DE BOUGIE ECO
PIPETTA CANDELA SCOOTER**

186993 NGK VB5E



**CAPUCHON DE BOUGIE
PIPETTA CANDELA**

186995 TRANSPARENT TRASPARENTE



**CAPUCHON DE BOUGIE
PIPETTA CANDELA**

186994 SILICONE ROUGE ROSSO
186997 CAOUTCHOUC NOIR NERO



**FIL DE BOUGIE
FILO CANDELA**

187001 L 10 M



**FIL DE BOUGIE AVEC COSSES
FILO CANDELA CON MORSETTO**

187000 L 53 CM

CARENZI



**FIL DE BOUGIE RACING
FILO CANDELA TNT RACING**

187002A

TRESSE DE MASSE TRECCIA DI MASSA

TNT
Original



***MBK 51**

S610 28 CM

INTERRUPTEUR TINTERRUTTORE

TNT
Original



208251



208251A

* Adaptable
* Adattabile

Les références du constructeur sont seulement indicatives et n'impliquent pas que les pièces de rechange viennent du constructeur.
I codici di riferimento originali sono indicativi e non implicano che i ricambi provengano necessariamente dalla stessa fabbrica del costruttore.

ELECTRICITE PARTI ELETTRICHE

CONTACTEUR DE STOP CONTATTO STOP

> CONTACTEUR DE STOP CONTATTO STOP



208255 *BOOSTER / BW'S

208257A
OEM: NM5839801000

208256 *PIAGGIO TYPHOON

208258A *PIAGGIO
OEM: 580953

208258 *PIAGGIO
OEM: 583575

208257B *CHINOIS TYPE A
LA PAIRE

208257D *CHINOIS TYPE B

208257C *CHINOIS TYPE C
M10 X 1.25MM

208257E *CHINOIS TYPE D
M10 X 1.0MM

208255A *XMAX 125CC
DROIT DX
OEM: 1B9H25300000

208255B *XMAX 125CC
GAUCHE SX
OEM: 1B9H25500000

> RUPTEUR & CONDENSATEUR ACCENSIONE



*SOLEX
S470 CONDENSATEUR VSX

*MBK
184095 RUPTEUR + CONDENSATEUR

> COUPE-CIRCUIT INTERRUTTORE EMERG.

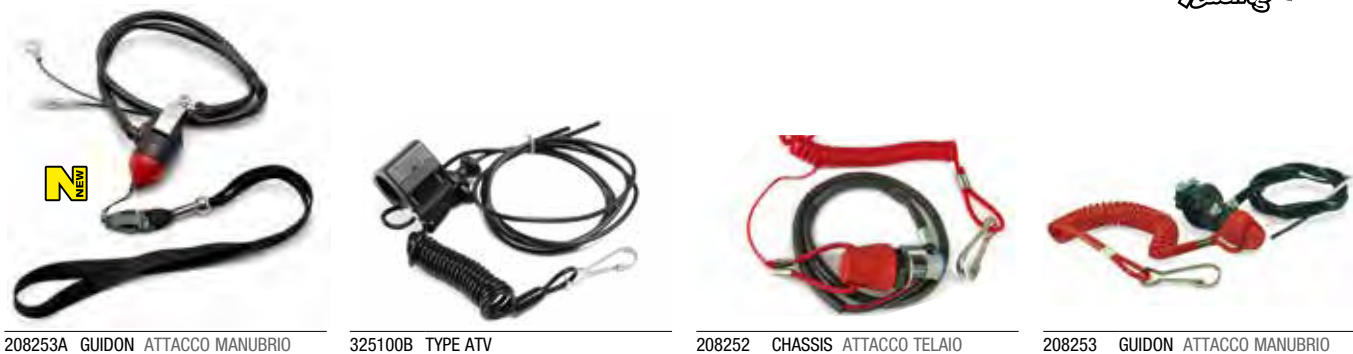

208253A GUIDON ATTACCO MANUBRIO

325100B TYPE ATV

208252 CHASSIS ATTACCO TELAIO

208253 GUIDON ATTACCO MANUBRIO

> COUPE-CIRCUIT INTERRUTTORE



*MOTO KAWASAKI
208250A

*MOTO KAWASAKI
208250B

*MOTO SUZUKI
208250C

*MOTO HONDA
208250D

➤ RELAIS RELE

TNT
Original



CENTRALE CLIGNOTANTS CENTRALINA FRECCE

187220	12V 23W (2 PLOTS)	(1)
187221	12V 23W (3 PLOTS)	(2)
187222	*SCOOTER CPI	(3)
187230	*BOOSTER 12V AVEC BUZZER	(4)
187220E	*BOOSTER 12V 23W (2 PLOTS)	(5)



CENTRALE CLIGNOTANTS A LEDS CENTRALINA FRECCE LED

206174A	1UNIVERSEL ELECTRONIQUE
---------	-------------------------



CENTRALE CLIGNOTANTS CENTRALINA FRECCE

187230A	*OVETTO NEOS
---------	--------------



RESISTANCE CLIGNOTANTS A LEDS COPPIA RESISTENZE FRECCE A LEDS

206175	10W LA PAIRE THE PAIR	(1)
206175A	21W LA PAIRE THE PAIR	



N
NEW

CENTRALE CLIGNOTANTS CENTRALINA FRECCE

187222B	*PIAGGIO VESPA 50PK / 125PX
OEM:192703	



N
NEW

CENTRALE CLIGNOTANTS CENTRALINA FRECCE

187222A	*PIAGGIO / KYMCO / HONDA
OEM: 292114/00151016	

➤ RELAIS DE DEMARREUR RELE AVVIAMENTO

TNT
Original



*PIAGGIO

OEM : 495190-582690
187223B



N
NEW

*KYMCO

OEM : 00169999 / 38500-KDK-900
187223D 12V 100A



RELAIS DEMARREUR RELE AVVIAMENTO

187223A	*BOOSTER / BW'S 99>03
---------	-----------------------



RELAIS PHARE / DEMARREUR RELE FARO / AVVIAMENTO

187223	*BOOSTER / BW'S
--------	-----------------

➤ PORTE-BALAIS DEMARREUR PORTA SPAZZOLE

TNT
Original



*YAMAHA TMAX 500 2001 - 08

OEM : 3HE818400000
187204



*HONDA SH 125

OEM : 31201-KFK-003 / PI. 58142R
187204A

ELECTRICITE PARTI ELETTRICHE DEMARREUR MOTORINI AVVIAMENTO

> SCOOTER

TNT
Original



***SPEEDFIGHT / TREKKER / LUDIX / TYPHOON / RUNNER**
OEM: 82530R - 00104002
187201



***SYM 50 MIO / MIO E2 / MIO E3 06/13**
OEM: 31200-A1A-000
187200A



***STRIKE / GRIDO / OTTO / ROMA**
971068D SCOOTER CHINOIS (GY6 50 4TPS)



***VESPA LX 50 4T 2006 / ZIP 50 4T 2006 / DERBI GPR / GPR Racing 50**
OEM: SM10-221 / 44800500 / 96921R
187200B



***STRADA / MONZA / ROMA 3**
971157M SCOOTER CHINOIS (GY6 50 4TPS)



***SCOOTER CHINOIS GY6 125CC 4T**
OEM: 00128741
970664D



***VESPA 50 PK XL ELESTART (V5X3T) 85/90**
OEM: 36635 / 179116 / 1491/65
187210J



***APRILIA / SUZUKI / MORINI**
OEM: 31100-36C02-000 / APZQ CA000041 / 611-102-00
187201A

> MAXISCOOTER

TNT
Original



***VESPA PX 125/150/200**
OEM: 249235
187210I



***PIAGGIO 125-150-180-200**
OEM: SM14-225 / 580442 / 82611R
187210B



***PIAGGIO 125-250-300CC BEVERLY / VESPA**
OEM: 58142R / 58.88R. / 58064R / 840235
187210C



***PIAGGIO 400CC MP3 2007-2011 / 400 / 500CC BEVERLY 2002-2008**
OEM: 82699R / SM13-524
187210E



***SUZUKI BURGMAN 125**
OEM: 31100-14F01
187210H



***HONDA SH300 07-13 / HONDA 250 NSS Forza X, EX (MF08) 08/12**
OEM: 31200-KTW-901 / 31200-KTW-B10 / 31200-KVZ-631
187210F



***HONDA SH / S-WING / PANTHEON 125/150**
OEM: 31200-KGF-901/902
187210G



***MAJESTY 125 / 150 / 180**
OEM: 5DSH18000000 - 487480179 - 74800300
187210



***YAMAHA TMAX 500 / 530**
OEM: 4B5818900000
187210L



***YAMAHA YP MAJESTY 250/400 / XMAX 250 / XCITY 250 / VP 300 VERSITY**
OEM: 4HC-81890-00 / 1SD-H1800-00
187210D



***YAMAHA XMAX 125CC / SKYCRUISER 125CC**
OEM: 1B9-H1800-01-00
187210A



***KYMCO GRAND DINK**
OEM: 31210-KHE7-900-M1 / 31200-HMA-000 / 31210-LBA7-900 / 31200-RB1-000
187210K

> 50CC A BOITE 50CC A MARCE

TNT
Original



***DAX REPLICA 50 / 125 (LONCIN)**
187203 2 POINTS DE FIXATION



***QUAD CHINOIS ENFANTS**
187203A 3 POINTS DE FIXATION



***MINARELLI AM6**
187202



MILLENIUM

ALLUMAGE ELECTRONIQUE ACCENSIONE ELETTRONICA

180000	*103 AM	EXT 102
180001	*103 SP NM / 103 SPX	EXT 103
180002	*MOB	EXT 100
180003	*MOB A KICK	EXT 101
180004	*103 SPX 2001 / VOGUE 12V	EXT 104
180005	*BOOSTER /STUNT	EXT 106
180006	*TREKKER	EXT 108
180006A	*LUDIX	EXT 110
180006B	*CPI / KEEWAY / GENERIC (1)	EXT 123
180007	*TYPHOON	EXT 109
180008	*NITRO / APRILIA SR	EXT 107
180009	*MINARELLI	EXT 112
180010	*DERBI	EXT 111
180011	*FOX FRANCAIS	EXT 105
180012	*TZR / RS1 / XR6	EXT 113
180013	*F10 / F12	EXT 114
180014	*DERBI GPR AVEC DEMARRAGE	EXT 115
180015	*FOX BELGIQUE	EXT 116
180016	*BOOSTER / STUNT CATALISE	EXT 119
180017	*NITRO CATALISE	EXT 120
180018	*TDR / XLIMIT CATALISE	EXT 121
180019	*TZR CATALISE	EXT 122

MILLENIUM

L'allumage MVT Millenium est le seul à posséder un rotor mono bloc forgé. Testé jusqu'à 22000 tours/mn il reste une valeur sûre pour une utilisation sur route ou circuit.

L'allumage Millénium possède une avance variable analogique qui augmente la combustion des gaz brûlés, diminuant ainsi les rejets polluants tout en améliorant l'accélération.

Grâce à sa connectique type origine il se monte très simplement et reprend la configuration électrique d'origine du véhicule.

Le Millénium bénéficie aussi d'une pré digitalisation, chaque rotor possède un double clavetage signalé par un A pour Analogique et un D pour Digital.

Pour passer d'un Millenium Analogique à Digital il suffit de changer le clavetage et de remplacer le diagramme Analogique par un Digimax qui met à votre disposition 3 courbes d'avance numérique avec 6 possibilités de réglage chacune.

L'accensione MVT Millenium è l'unica ad avere un unico gruppo rotore forgiato. Testata fino a 22.000 giri / min' è una scelta sicura per l'utilizzo su strada o su pista.

L'accensione Millennium ha un anticipo variabile analogico che aumenta la combustioni dei fumi, riducendo così lo scarico inquinante e migliorando l'accelerazione.

Grazie ai suoi connettori standard, si installa molto semplicemente, utilizza quindi una configurazione/connessione elettrica originale del veicolo.

La Millennium beneficia anche di una pre-digitalizzazione, ogni rotore ha una doppia codifica indicata da una A per Analogico e D per il Digitale.

Per passare da Millenium Analogica a Digitale è sufficiente cambiare la codifica e sostituire la centralina analogica con una Digimax digitale, la quale mette a disposizione 3 curve d'anticipo digitali con 6 possibili impostazioni per ciascuna.



DIAGRAMME POUR ALLUMAGE ELECTRONIQUE DIAGRAMMA PER ACCENSIONE

180077A	> EXT 100-101-109-111-112-113-114-115
180077B	> EXT 102-103-104-105-108-116
180137	> EXT 106-107
180137A	> EXT 119-120
180137B	> EXT 121-122



PREMIUM

ALLUMAGE ELECTRONIQUE AVEC LUMIERE
ACCENSIONE ELETTRONICA CON LUCE

180120	*MBK 51	PREM 01
180121	*103 AM	PREM 02
180122	*103 NM	PREM 03
180123	*BOOSTER / NITRO	PREM 06
180124	*TREKKER	PREM 08
180125	*PIAGGIO	PREM 09
180126	*LUDIX	PREM 10
180127	*SENDA	PREM 11
180128	*AM6	PREM 12
180129	*BOOSTER / NITRO CATALISE (1)	PREM 19
180130	*AM6 CATALISE	PREM 21
180131	*CPI / KEEWAY / GENERIC	PREM 23

DIAGRAMME POUR ALLUMAGE PREMIUM
DIAGRAMMA PER ACCENSIONE PREMIUM

180136	> PREM 01 - 09 - 11
180136A	> PREM 02 - 03 - 08
180136B	> PREM 06 (1)
180136C	> PREM 10
180136D	> PREM 19 - 21
180136E	> PREM 23
180136F	> PREM 12

PREMIUM

Allumage MVT Premium, rotor interne en aluminium avec système d'éclairage. Tous les systèmes premium sont équipés d'un régulateur de vitesse pouvant brider votre véhicule à 45KM/h (fil bleu à la masse).

Avec un rotor en aluminium ne pesant que 250grs, les montées en régime deviennent impressionnantes

Le boîtier d'avance variable est spécifique à chaque modèle pour garantir des performances idéales.

En option vous pouvez opter pour un système « Eprom », il s'agit d'un calculateur numérique multi-courbes spécialement développé pour les grosses configurations. Ce boîtier vous permettra d'ajuster la courbe d'avance à l'allumage afin d'optimiser au mieux votre configuration.

Pour faciliter le montage de ces allumages toute la connectique est de type origine et le calage s'effectue au point mort haut.

Accensione MVT Premium, rotore interno in alluminio con uscita luci. Tutti i sistemi Premium sono dotati di regolatore di velocità per limitare veicolo 45KM / h. (filo blu a massa).

Con un rotore in alluminio che pesa solo 250gr, il regime del numero di giri/m' diventa impressionante!

La posizione dell'anticipo variabile è specifica per ogni modello per garantire assolute prestazioni ideali.

In alternativa, si può optare per un sistema «EPROM», un computer digitale multi-curvatura sviluppato specificatamente per configurazioni da gara di grandi diametri. «EPROM», consente di regolare i tempi di curva d'accensione per ottimizzare la vostra configurazione.

Per facilitare il montaggio di queste accensioni tutte le connessioni sono tipo le originali e la taratura si effettua al punto morto superiore.

EPRON

UNITE DIGITAL POUR ALLUMAGE PREMIUM
UNITÀ DIGITALE PER ACCENSIONE PREMIUM

180135	> PREM 01 - 09 - 11 - 12
180135A	> PREM 02 - 03 - 08
180135B	> PREM 06 - 23
180135C	> PREM 10
180135D	> PREM 19 - 21
180135E	> PREM 09 - 11 - 12 EPROM 6

BOBINE BOBINA

180077	MVT BO PX 20
--------	--------------



DIGITAL DIRECT

ACCENSIONE DIGITALE CON LUCE
DIGITAL IGNITION WITH LIGHT

180140	*BOOSTER / NITRO AM	DD06
180140A	*BOOSTER / NITRO NM	DD19
180140B	*TREKKER / SPEEDFIGHT	DD08
180140C	*LUDIX	DD10
180140D	*PIAGGIO / GILERA	DD09
180140E	*DERBI SENDA	DD11
180140F	*AM6 (sauf MBK / YAMAHA Euro 2)	DD12
180140G	*DT / XLIMIT Euro 2	DD21
180140H	*CPI / KEEWAY	DD23
180140I	*PEUGEOT 103 POUR CONE	DD02
180140J	*PEUGEOT 103 ELECTRONIQUE	DD03
180140K	*MBK 51	DD01

DIGITAL DIRECT

Adopté par tous les Teams sérieux des différents Championnats de vitesse et d'endurance en Europe, l'allumage Digital Direct MVT offre une puissance de 42 Kilos volts à partir de 8000 tours, ce qui augmente considérablement la puissance de l'étincelle.

Associée à une courbe Digital (étudiée par le service course MVT) et à la fiabilité légendaire du Premium, le Digital Direct accumule les victoires depuis sa sortie.

En plus de sa performance l'allumage Digital Direct permet l'utilisation d'une pompe à eau électrique alimentée directement derrière un régulateur type origine sans utiliser de batterie.

Il délivre 55 Watts pouvant aussi alimenter de l'éclairage pour les courses d'endurance.

Adottato da tutti i Team importanti dei diversi campionati di velocità e resistenza/ endurance in Europa, l'accensione Digital Direct MVT offre una potenza di 42 Kw a 8.000 giri/m', questo aumenta significativamente la potenza della scintilla.

Associata alla centralina Digital (studiata dal servizio corse MVT) la leggendaria affidabilità Premium Digital Direct accumula sempre più vittorie dalla sua presentazione.

Oltre alle prestazioni, l'accensione Digital Direct permette l'uso della pompa acqua elettrica, alimentata direttamente tramite un regolatore tipo l'originale, senza quindi utilizzare la batteria.

Esso fornisce 55 Watt e può anche fornire la potenza di illuminazione per gare di durata/endurance.



DIAGRAMMA PER ACCENSIONE
DIAGRAM FOR ELECTRONIQUE IGNITION

180141	RJ 35/63 DD06
180141A	RJ 34/81 DD19
180141B	RJ 34/61 DD12

➤ **SCOOTER**

TNT
Original



***BOOSTER 2004>/NITRO 2004>STUNT 2004>**
180310



***BOOSTER ≤ 2002 / NITRO ≤ 2002**
180310A



***TYPHOON ANCIEN MODELE VECCHIO MODELLO**
180310B OEM : 830294



***DERBI / AM6 (DUCATI)**
180310C OEM: 47065/82852R



***TYPHOON/ NRG 50**
180310D OEM: 584525/639865/830296



***LUDIX**
180310E OEM: 768349



***SPEEDFIGHT / TREKKER 50
SANS ANTIDEMARRAGE**
180310F



***CPI SM / SX**
180310G OEM: 51A-21100-20-00



***DT 50 / XLIMIT / XPOWER / TZR 50 ≥ 2007**
180310H



***SCOOTER CHINOIS 50CC 2T GY6**
971064X GY6 1PE40QMB



***SCOOTER CHINOIS 50CC 4T GY6**
971157J



***PIAGGIO 50 ZIP / FLY / LX 4T**
180310I OEM: 969228



***PIAGGIO 50 4T SCARABEO / VESPA S 50**
180310J OEM : 833632

ELETRICITE PARTI ELETTRICHE ALLUMAGE ACCENSIONE

➤ MAXI SCOOTER

TNT
Original



***SCOOTERONE 125 GY6**
970664P GY6 4T 152QMI



***PIAGGIO X9 125CC / VESPA LX / ET4 125CC**
180311C OEM: 584690



***PIAGGIO MP3 125 / BEVERLY 250 / 300**
180311 OEM: 58070R / 58112R / 638848



***PIAGGIO X9 250CC / BEVERLY 250CC**
180311D OEM: 58048R



***PIAGGIO 400 MP3**
180311B OEM: 58108R



***PIAGGIO BEVERLY 400 / 500 / X9**
180311A OEM: 58080R



***YAMAHA TMAX 500 2001-2003**
180312 OEM: 5GJ814100100



***YAMAHA TMAX 500 2008-2011**
180312A OEM: 5VU814100200



***YAMAHA TMAX 500 2008-2011**
180312B OEM: 4B5814100000



***YAMAHA XMAX 125**
180312E OEM: 1B9-H1410-00



***HONDA SH 125 / 150**
180313 OEM: 31120-KTF-640

N



CLAVETTE ALLUMAGE CHIAVETTA ACCENSIONE

181000	Ep:2mm	H:3.7mm	L:9.2 mm	(x10)
181000A	Ep:3mm	H:3.7mm	L:9.2 mm	(x10)
181000B	Ep:4mm	H:6.5mm	L:15.6 mm	(x10)

* Adaptable
* Adattabile

Les références du constructeur sont seulement indicatives et n'impliquent pas que les pièces de rechange viennent du constructeur.
I codici di riferimento originali sono indicativi e non implicano che i ricambi provengano necessariamente dalla stessa fabbrica del costruttore.

ELETRICITE PARTI ELETTRICHE REGULATEUR DE TENSION REGULATORE DI TENSIONE

> SCOOTER

TNT
Original



***BOOSTER ≤ 2002 / *NITRO ≤ 2002**
180350 OEM: 02601100 / 2727800000



***BOOSTER ≤ 2003 / *NITRO ≤ 2003**
***CPI SM/SX**
180350A 5RN-H1960-00-00



***CPI SCOOTER**
180351 OEM: 02601500 / 02603500 / 31600-KBN-920



***DERBI 2009-2012**
180353B OEM: 898891



***DERBI**
180353 DUCATI



***DERBI**
180353A LEONELLI



***PEUGEOT SCOOTER**
180354 OEM: 00169004 / 00169547 / 743352



***TYPHOON / NRG / STALKER / ZIP 2T**
180355 OEM: 58096R / 82587R



***ZIP / FLY / LIBERTY / VESPA LX 50**
180355A OEM: 639751 / 641788 / 02602800



***PIAGGIO APE / VESPA ET2/PK/PX125**
180355E OEM: 2940165



***RIEJU / APRILIA 12V**
180351A OEM: AP8212121 / 005.070.4710

> MAXI SCOOTER

TNT
Original



***HONDA SH 125/150 ≤ 05-12**
***HONDA PSI 125/150 ≤ 06-12**
180357A OEM: 31600-KTF-641



***HONDA DYLAN 125/150 ≤ 01-06**
***HONDA SH 125 ≤ 01-04**
180357 OEM: 31600-KGF-860 / 02601900 / 496454



***KYMCO 50 / 125 / 200CC**
180356B OEM: 00169587 / 02603000



***KYMCO 125 / 200 / 300**
***SYM 125 / 200 / 300**
180356A OEM: 00168780 / 02601800 / 31600-M56-000 / 495186



***KYMCO 125 / 200 / 200CC**
180356 OEM: 31600-KED9-900 / 00177005



***PIAGGIO 125**
***APRILIA 125**
***GILERA 125**
180355B OEM: 292033



***PIAGGIO X9 500 / MP3 400/500**
180355C OEM: 58086R



***PIAGGIO APE**
180355D OEM: 157714



***YAMAHA TMAX 500 01-04**
***YAMAHA MAJESTY 250**
180352A OEM: 5VX-8196-00-00 / 4JH-8196-01-00



***MAJESTY / SKYLINER**
180352 OEM: 4HMH19600000

ELETRICITE PARTI ELETTRICHE BOBINE COMANDI MANUBRIO

> BOBINE / CDI BOBINA / CDI

TNT
Original



***PEUGEOT SCOOTER**
180026



***TREKKER / LUDIX**
180021A TYPE DELL ORTO



***STALKER / TYPHOON / RUNNER**
180297



***BOOSTER / AEROX / PW50**
180299 OEM: 3KJ823101000



***CPI SCOOTER**
180304



***ROMA 2/3 4T**
970919K *SCOOTER CHINOIS GY6



***STRIKE GHOST OTTO GRIDO ROMA**
971060R *SCOOTER CHINOIS 2T GY6



***PIAGGIO / VESPA ZIP 4T / LX4 / ET4 50**
180297C OEM: 639978



***PIAGGIO / GILERA**
180297A OEM: 214417 / 2441275



***PIAGGIO / VESPA**
180297B OEM: 292194



***PIAGGIO / VESPA ET4 / LX4 125**
180297D OEM: 294150



***NEXUS 125 E3 / MP3 400/500**
***VESPA S.50/125**
180026A OEM: 58120R



***DERBI**
180298 *DUCATI (OEM:02402200)



***DERBI**
180298A *LEONELLI



***PEUGEOT 103 / CIAO (RUPTEUR)**
180300

> CDI CENTRALINA

TNT
Original



***BOOSTER > 2002**
***NITRO > 2002**
180023



***BOOSTER ≥ 2004**
***NITRO ≥ 2004**
180023A



***CPI SCOOTER**
180022



***VCLIC / KISBEE**
180021B



***PEUGEOT SCOOTER**
180021



***SCOOT CHINOIS 4T**
50CC & 125CC
180022A



***SYM - *PGO 50 / 125**
180022C OEM: 30410-M70-000 / 30410-M92-000



***APRILIA - *GILERA -**
***PIAGGIO 125 / 150**
180024 OEM: 2920345 / AP8124685



***CPI SM/SX**
180022B OEM: 51A-23110-20-00

* Adaptable
* Adattabile

Les références du constructeur sont seulement indicatives et n'impliquent pas que les pièces de rechange viennent du constructeur.
I codici di riferimento originali sono indicativi e non implicano che i ricambi provengano necessariamente dalla stessa fabbrica del costruttore.

AS 221

ELECTRICITE PARTI ELETTRICHE COMMUTATEUR COMANDI MANUBRIO

TNT
Original

COMANDI MOTO
domino



***BOOSTER 2004**

NOIR NERO
324010 DROIT DESTRA



***BOOSTER 2004>**

NOIR NERO
324010B DROIT DESTRA



***BOOSTER / BW'S 2000**

D R G L NOIR NERO
325009 325008 COMPLET COMPLETO



***BOOSTER 2004 / NEXT 2000 / STUNT**

NOIR NERO
324000 GAUCHE SINISTRA
324010A DROIT DESTRA



***BOOSTER 2004>/NEXT 2000/STUNT/SLIDE**

NOIR NERO
324000C GAUCHE SINISTRA
324000D GAUCHE ARRIERE ANTERIORE-SINISTRA



***YAMAHA NITRO/AEROX**

NOIR NERO
325045A GAUCHE SINISTRA
325040A DROIT DESTRA



***PIAGGIO**

NOIR NERO
324000B GAUCHE SINISTRA



325100A UNIVERSEL UNIVERSALE



CROSS

325100 UNIVERSEL UNIVERSALE



***SENDA DRD / XTREM / RACER**

324000A GAUCHE SINISTRA

ELETRICITE PARTI ELETTRICHE CONTACTEUR A CLE KIT SERRATURE

> SCOOTER

TNT
Original



***BOOSTER / STUNT**
208221



***BOOSTER 2003 / STUNT 2005**
208221A



***BOOSTER 2004**
208221B



***BOOSTER / NEXT**
208222



***BOOSTER NEXT 2003**
208222A



***NITRO / AEROX**
208220



***NITRO 2003 / AEROX 2003**
208220A



***OVETTO / NEOS**
208219



***OVETTO 2008 / NEOS 2008**
208219A



***LUDIX 50**
208210F



***LUDIX / TREND / SNAKE**
208213



***BUXY / SPEEDAKE**
208211



***SPEEDFIGHT / TREKKER**
208212



***SPEEDFIGHT 2 / VIVACITY**
208214



***SPEEDFIGHT 3 / VIVACITY 3**
208214A



***FOX**
208226



***MACH-G 2002**
208217



***MALAGUTI F12**
208231



***KISBEE 2T-4T**
208214B



***SCOOTER CPI ARAGON**
208229B

* Adaptable
* Adattabile

Les références du constructeur sont seulement indicatives et n'impliquent pas que les pièces de rechange viennent du constructeur.
I codici di riferimento originali sono indicativi e non implicano che i ricambi provengano necessariamente dalla stessa fabbrica del costruttore.

ELETRICITE PARTI ELETTRICHE CONTACTEUR A CLE KIT SERRATURE

> SCOOTER

TNT
Original



***TYPHOON / STALKER / NRG**
208223



***LIBERTY / ET2 / RUNNER**
208223B



***PIAGGIO ZIP 50 2T/4T**
208223G OEM: 643133 - 298581 - 573512



***MONZA 50 4T 2T**
208229A GY6 50cc TYPE B



***ROMA 2/3 ET ROMA 2 T**
970919L GY6 50cc TYPE A



***HONDA X8 RX 50**
208210C



***HONDA SFX 50**
208210B



***CITY 1&2 / SPIGAOU 50&125 / ST 50.6 - 125.6**
208210I



**SERRURE DE SELLE
SEAT LOCK**

208221C *PIAGGIO MP3 400-500 / SYM FIDDLE
*OVETTO 2007 / BOOSTER 2004

> MAXI SCOOTER

TNT
Original



***LEONARDO 125**
208210



***X8 / X9 125**
208223C



***ELYSTAR 125**
208210E



***SKYLINER / MAJESTY 125**
208210D



***HONDA SH 125 / 150 2005**
208210H OEM: 404390505



***HONDA SH 125 / 150**
208210G OEM: 404390500

ELETRICITE PARTI ELETTRICHE CONTACTEUR A CLE KIT SERRATURE

> 5OCC A BOITE 5OCC A MARCE

TNT
Original



***APRILIA RS < 2003**
208218



***DERBI SENDA < 2003**
208224



***DERBI SENDA > 2003**
208224A



***XP6 2006 / XPS**
208227B



***XR6**
208228



***XPOWER / TZR**
208229



***XLIMIT / DT 50**
208230



***MOTO CPI SM/SX**
208229C

> COMMUTATEUR DE CONTACTEUR A CLE COMMUTATORE

TNT
Original



***PIAGGIO X9 / ET2**
208223D



***PIAGGIO X8 X9 EVOL**
208223F



***PIAGGIO NRG/TYPHOON**
208223E

> CAPUCHON CONTACTEUR A CLE CORNICE CONTATTO

TNT
Tuning



***BOOSTER / BW'S / CPI**
208284 STYLE CARBONE CARBONIO



***BOOSTER 2004 / NITRO / OVETTO**
208263 CHROME CROMO
208264 STYLE CARBONE CARBONIO

ELECTRICITE PARTI ELETTRICHE COMPTEUR STRUMENTAZIONE

KOSO

TNT
Racing

TNT
Original



COMPTEUR STRUMENTAZIONE

164026A CHROME CROMO



COMPTEUR SENSEUR VELOCITA RICAMBIO KOSO XR01

164027 COMPTEUR DIGITAL MULTI FONCTIONS



CAPTEUR DE VITESSE SENSORE VELOCITÀ

164025A POUR COMPTEUR PER STRUMENT. 164025 (1)

164026C POUR COMPTEUR PER STRUMENT. 164026A (2)



TNT
Original



THERMOMETRE TERMOMETRO

180028 UNIVERSEL UNIVERSALE



CAPTEUR DE VITESSE

ADATTATORE PER DEMOLTIPLICATORE

164025B



AIMANT DE COMPTEUR IMÁN

164025C 3PCS POUR COMPTEUR KOSO



*BOOSTER / BW'S ANCIEN MODELE VECCHIO MODELLO

COMPTEUR STRUMENTAZIONE

164020 180 KM/H



*BOOSTER / BW'S NOUVEAU MODELE NUOVO MODELLO

COMPTEUR STRUMENTAZIONE

164021 180 KM/H



*BOOSTER 2004 / BW'S 2004

VERRE DE COMPTEUR VETRO STRUMENTAZIONE

164261B FUMÉ SMOKE

164261C TRANSPARENT TRASPARENTE

ELECTRICITE PARTI ELETTRICHE COMPTEUR STRUMENTAZIONE



COMPTE-TOURS COMPTEUR D'HEURE
CONTAGIRI CONTAORE

180029A



COMPTEUR D'HEURE MOTEUR
CONTAORE MOTORE

180028A
180028B SUPPORT SUPPORTO (1)



(1)

ENTRAINEUR DE COMPTEUR RINVIO CONTACHILOMETRI



***BOOSTER / BW'S / NITRO / AEROX**

164215



***CPI SCOOTER**

164216



***PEUGEOT VIVACITY**

164215A



***YAMAHA NEOS >2008**

164215B OEM: 1P9H37560000



***YAMAHA NEOS ELECTRONIQUE**

164217 OEM: 5C2H37560000



***PIAGGIO ZIP NEW MODEL**

164215C

ALARME ALLARME



(1)

Alarme TNT universelle complete comprenant :

- Avertisseur sonore + boîtier électronique + fils électrique de connexion
- Notice de montage
- alarme adaptable sur tous types de scooter

Antifurto universale TNT completo di :

- Allarme sonoro + unità di controllo + fili elettrici di connessione
- Istruzioni di montaggio
- Antifurto adattabile su tutti i tipi di scooter e moto



ALARME ALLARME MOTO / SCOOTER

187146 COMPLET COMPLETO

187165 SIRENE SEULE SOLO SIRENA (1)



SIRENE SIRENA

187166A 12 V



KLAXON GLACSON

187166 CHROME CROMO

* Adaptable
* Adattabile

Les références du constructeur sont seulement indicatives et n'impliquent pas que les pièces de rechange viennent du constructeur.
I codici di riferimento originali sono indicativi e non implicano che i ricambi provengano necessariamente dalla stessa fabbrica del costruttore.

ECLAIRAGE

- > AMPOULE
- > TETE DE FOURCHE
- > OPTIQUE
- > FEUX ARRIERE
- > CABOCHONS
- > CLIGNOTANT
- > FEU DECORATIF

LUCI

- > LAMPADINA
- > MASCHERA FARO
- > LUCI
- > FARO POSTERIORE
- > GEMME FARO
- > FRECCIE
- > LUCI TUNING

ECLAIRAGE LUCI

AMPOULE LAMPADINA



AMPOULES BA9S							
Dessin	Culot	Verre	Volt	Puiss.	Couleur	Code	Nbr.
	BA9S ERGOT 120°	T8,5	12V	21W	TRANSP.	222042E	x10
					ORANGE	222042D	
	BA9S	G11	12V	10W	BLEU	222054	

AMPOULES BA15S							
Dessin	Culot	Verre	Volt	Puiss.	Couleur	Code	Nbr.
	BA15S ERGOT 120°	G18	12V	10W	TRANSP.	222042A	x10
					TRANSP.	220115	
	BA15S	G18,5	12V	5W	ROUGE	•220115A	x10
					VERT	•220112	
	BA15S	G18,5	12V	10W	TRANSP.	220610	x10
					TRANSP.	222042B	
	BA15S	S25	12V	21W	BLEU	•220101	

AMPOULE E							
Dessin	Culot	Verre	Volt	Puiss.	Couleur	Code	Nbr.
	E10	G11	6V	3W	TRANSP.	220490	x10

AMPOULES BAY 15D							
Dessin	Culot	Verre	Volt	Puiss.	Couleur	Code	Nbr.
	BAY15D	S25	12V	21/5W	TRANSP.	222042I	x10

AMPOULES BA20D							
Dessin	Culot	Verre	Volt	Puiss.	Couleur	Code	Nbr.
	BA20D	B35	12V	35/35W	TRANSP.	222042L	x1

AMPOULES P26S							
Dessin	Culot	Verre	Volt	Puiss.	Couleur	Code	Nbr.
	P26S	HALO-GENE	12V	15W	TRANSP.	222035	x1
	P26S	S25	12V	15W	TRANSP.	222042M	

HALOGENE DICHROIDE							
Dessin	Culot	Verre	Volt	Puiss.	Couleur	Code	Nbre.
	Dichroide	D50	12V	25W	TRANSP.	•222100	x1
					BLEU	•222101	
		D34	12V	20W	TRANSP.	•222105	

AMPOULES T							
Dessin	Culot	Verre	Volt	Puiss.	Couleur	Code	Nbre.
		T5	12V	1,2W	VERT	•220153	x10
		T10	12V	3W	TRANSP.	222042F	
		T13	12V	10W	TRANSP.	222042G	x10
		T16	12V	10W	TRANSP.	222042H	
		T20	12V	21/5W	TRANSP.	220136	x10
		T20	12V	21/5W	ORANGE	•220137	

AMPOULES HS							
Dessin	Culot	Verre	Volt	Puiss.	Couleur	Code	Nbre.
	PK 43T	H4	12V	35/55W	TRANSP.	222042J	x1
	PK 43T	H4	12V	60/55W	TRANSP.	222042K	
	PK 22S	H3	12V	55W	TRANSP.	222042N	
	Ampoule Kit Habillage Stunt	H8	12V	35W	TRANSP.	220094	

PORTE-AMPOULE			
Dessin		Code	Nbre.
	DOUILLE CERAMIQUE CONNETTORE CERAMICA	222110	x1
	PORTE AMPOULE ADAPTABLE BOOSTER PORTA LAMPADINA BOOSTER	222038	
	PORTE AMPOULE ADAPTABLE BOOSTER 2004 PORTA LAMPADINA BOOSTER 2004	222038A	
	DOUILLE AMPOULE H8 AVEC FILS	(POUR KIT HABILLAGE STUNT TNT)	220094A

EXEMPLE DE NORMALISATION DE DÉNOMINATION D'UNE AMPOULE ESEMPIO DI CODIFICA LAMPADINA

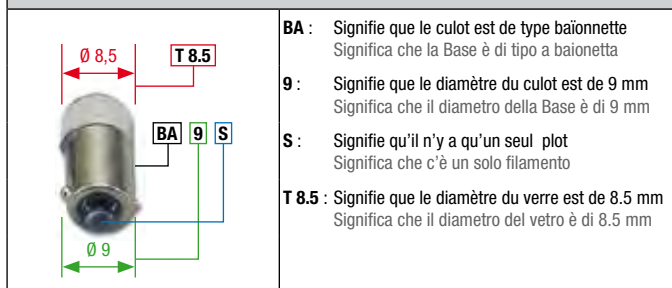

BA : Signifie que le culot est de type baïonnette
Significa che la Base è di tipo a baionetta

9 : Signifie que le diamètre du culot est de 9 mm
Significa che il diametro della Base è di 9 mm

S : Signifie qu'il n'y a qu'un seul plot
Significa che c'è un solo filamento

T 8.5 : Signifie que le diamètre du verre est de 8.5 mm
Significa che il diametro del vetro è di 8.5 mm

LEGENDE LEGENDA

CULOT BASE

BA / BAY : Culot de type bayonnette
Base di tipo a baionetta

E : Culot de type pas de vis
Base di tipo filettato

P : Culot à Picot
Base a lamelle

S : Un seul plot
Un solo contatto

D : Deux plots
Due contatti

T : Ampoule uniquement en verre dont le bout est aplati
Lampadina con solo vetro la cui base è appiattita

H(x) : Ampoule européenne normalisées
Lampadina europea normalizzata

VERRE VETRO

G : Verre globe
Attacco a spina

T : Verre droit
Vetro destro



OSRAM

S15550	LAMPE 12V 1.2W T5 W2X4 OSRAM T5 COMPTEUR (LAMPE SANS CULOT)	(1)
S70003	LAMPE 12V 5W BA15S OSRAM	(2)
S45008	LAMPE 12V 10W BA15S OSRAM	(3)
S7528	LAMPE 12V 21/5W BAY15D OSRAM	(4)
S70082	LAMPE 12V 21W BA15S OSRAM	(5)
S293	LAMPE 12V 35/35W HS1 PX43T OSRAM HALOGENE	(6)
S717003	LAMPE 12V H4 60/55W OSRAM X RACER TYPE XENON (BLISTER DE 2)	
S717002	LAMPE 12V H7 OSRAM NIGHT RACER (BLISTER DE 2)	

TNT Original

222042A	AMPOULE CLIGNOTANT BA15S 12V-10W HOMOLOGUEE CE (BOITE DE 10)
222042B	AMPOULE CLIGNOTANT BA15S 12V-21W HOMOLOGUEE CE (BOITE DE 10)
222042C	AMPOULE CLIGNOTANT BAU15S 12V-5W HOMOLOGUEE CE (BOITE DE 10)
222042I	AMPOULE FEU STOP BAY15D 12V-21W/5W HOMOLOGUEE CE (BOITE DE 10)
222042N	AMPOULE PROJECTEUR H3 12V-55W HOMOLOGUEE CE (UNITE)
222042K	AMPOULE PROJECTEUR H4 PX43-T 12V-60W/55W HOMOLOGUEE CE (UNITE)
222042J	AMPOULE PROJECTEUR HS1 PX43T 12V-35/35W HOMOLOGUEE CE (UNITE)
222042L	AMPOULE PROJECTEUR S2 BA20D 12V-35W/35W HOMOLOGUEE CE (UNITE)
222042M	AMPOULE PROJECTEUR SB25 P26S 12V-15W HOMOLOGUEE CE (UNITE)
222042E	AMPOULE TEMOIN BAU9S 12V-21W HOMOLOGUEE CE (BOITE DE 10)
222042D	AMPOULE TEMOIN BAU9S 12V-21W ORANGE HOMOLOGUEE CE (BOITE DE 10)
222042F	AMPOULE TEMOIN T10 12V-3W HOMOLOGUEE CE (BOITE DE 10)
222042G	AMPOULE TEMOIN T13 12V-10W HOMOLOGUEE CE (BOITE DE 10)
222042H	AMPOULE TEMOIN T16 12V-10W HOMOLOGUEE CE (BOITE DE 10)
220088	LAMPE HALOGENE H1 P14 5S 12V 55W (UNITE)
220091	LAMPE HALOGENE H7 PX 26D 12V 55W (UNITE)

ECLAIRAGE LUCI

TETE DE FOURCHE MASCHERA FARO

TNT
Tuning



MANGA

448140	NOIR NERO
448141	BLANC BIANCO
448144	STYLE CARBONE CARBONIO



WINTERBEE

448125	BLANC BIANCO
448125A	NOIR NERO
448125B	STYLE CARBONE CARBONIO



DUKE

448126	ROUGE ROSSO
448127	BLEU BLU
448128	BLANC BIANCO
448129	NOIR NERO
448130	STYLE CARBONE CARBONIO



TRANSFORMER

448138	NOIR NERO
448138A	BLANC BIANCO

ECLAIRAGE LUCI

TETE DE FOURCHE MASCHERA FARO

TNT
Tuning

ENDURO



NOEND SX

- | | |
|---------|----------------|
| 448147 | NOIR NERO |
| 448147A | BLANC BIANCO |
| 448147B | ORANGE ARANCIO |



MASTER

- | | |
|---------|----------------|
| 448146 | NOIR NERO |
| 448146A | BLANC BIANCO |
| 448146B | ORANGE ARANCIO |
| 448146C | BLEU BLU |



ENDURO

- | | |
|--------|------------------------|
| 448193 | ROUGE ROSSO |
| 448194 | BLEU BLU |
| 448197 | BLANC BIANCO |
| 448198 | NOIR NERO |
| 448199 | STYLE CARBONE CARBONIO |



CROSS

- | | |
|--------|------------------------|
| 448133 | ROUGE ROSSO |
| 448134 | BLEU BLU |
| 448135 | BLANC BIANCO |
| 448136 | NOIR NERO |
| 448137 | STYLE CARBONE CARBONIO |



CROSS

- | | |
|---------|--------------|
| 448132 | ROUGE ROSSO |
| 448132A | BLEU BLU |
| 448132B | BLANC BIANCO |
| 448132C | NOIR NERO |



ELASTIC ELASTICI

X4

- | | |
|--------|---|
| 448192 | POUR TETE DE FOURCHE ENDURO
PER MASCHERA FARO ENDURO |
|--------|---|

* Adaptable
* Adattabile

Les références du constructeur sont seulement indicatives et n'impliquent pas que les pièces de rechange viennent du constructeur.
I codici di riferimento originali sono indicativi e non implicano che i ricambi provengano necessariamente dalla stessa fabbrica del costruttore.

ECLAIRAGE LUCI OPTIQUE FARO ANTERIORE



*BOOSTER / BW'S

4 HALOGEN + LED

201301 NOIR NERO

201301A BLANC BIANCO

*BOOSTER / BW'S

2 HALOGEN

201310 BLANC BIANCO

201311 NOIR NERO

201315 STYLE CARBONE CARBONIO



*BOOSTER / BW'S

2 HALOGEN + LED

201365 BLANC BIANCO

*BOOSTER 2004 / BW'S 2004

2 HALOGEN

201308 BLANC BIANCO

201308A NOIR NERO

201308B STYLE CARBONE CARBONIO



*BOOSTER 2004

2 HALOGEN + LED EYELIGHT

201307 BLANC BIANCO

201307A NOIR NERO

201307B STYLE CARBONE CARBONIO

*NITRO / AEROX

2 HALOGEN

201350 BLANC BIANCO

201351 NOIR NERO

201353 STYLE CARBONE CARBONIO



*NITRO / AEROX

2 HALOGEN

AVEC LED CON LED

201302

201302A

201302D

SANS LED SENZA LED

201390

201390A

201390D

NOIR NERO

BLANC BIANCO

STYLE CARBONE CARBONIO

*NITRO / AEROX

2 HALOGEN + LED EYELIGHT

201303 BLANC BIANCO

201303A NOIR NERO

201303B STYLE CARBONE CARBONIO

ECLAIRAGE LUCI OPTIQUE FARO ANTERIORE



*NITRO / AEROX

2 HALOGEN + CLIGNOTANTS A LED + FRECCE A LED

201370 BLANC BIANCO

201373 STYLE CARBONE CARBONIO

CLIGNOTANTS FRECCE *201370 & 201373

201358B ORANGE ARANCIO



*SPEEDFIGHT

2 HALOGEN + LED EYELIGHT

201330 BLANC BIANCO

201330A NOIR NERO

*ROCKET / NEXT

2 HALOGEN + LED SPACE

201360 CHROME LED BLEU CROMO LED BLU

201363 BLANC LED BLEU BIANCO LED BLU



*MACH-G

2 HALOGEN + CLIGNOTANTS A LED + FRECCE A LED

201375 BLANC BIANCO

201375A NOIR NERO

*RUNNER

4 HALOGEN

201385 BLANC BIANCO

201385A NOIR NERO

201385B STYLE CARBONE CARBONIO



*TYPHOON

2 HALOGEN

201345 STYLE CARBONE CARBONIO

201346 BLANC BIANCO

201347 NOIR NERO

ECLAIRAGE LUCI OPTIQUE FARO ANTERIORE

> SCOOTER



***NITRO**
204330A HOMOLOGUÉ OMOLOGATO



***OVETTO / NEOS >2007**
204343B HOMOLOGUÉ OMOLOGATO



***CPI SX/SM 50 >2007**
204332 HOMOLOGUÉ OMOLOGATO



***JOG-R / MACH-G**
204331 HOMOLOGUÉ OMOLOGATO

> MAXI SCOOTER



***YAMAHA TMAX 500 2003-2007**
204366 OEM : 5GJ843101000



***YAMAHA TMAX 500 2008-2012**
204366A OEM : 4B5843100200



***YAMAHA TMAX 500 2008-2012**
204366B OEM : 4B5843100200



***YAMAHA TMAX 530 2012 / 2014**
204366C OEM : 59C-84300-00

> PHARE & OPTIQUE CYCLO FARO & FARI CICLOMOTORE



PHARE CHROME FARO CROMO
202540 HOMOLOGUÉ OMOLOGATO



***CIAO PX**
S56672 HOMOLOGUÉ OMOLOGATO

ECLAIRAGE LUCI

FEU ARRIERE SCOOTER FARO POSTERIORE SCOOTER

TNT
Tuning

NOEND



FEU A LED REAR LAMP WITH LED

204400 CHROME CROMO
204405 CARBONE CARBONIO



SPACE (15 LED)

204410 TRANSPARENT TRASPARENTE
204411A TRANSP. HOMOLOGUÉ
204412 ROUGE ROSSO



SPACE PLUS (LED)

AVEC ECLAIRAGE DE PLAQUE
CON LUCI TARGA
204415 ROUGE ROSSO
204415B TRANSPARENT TRASPARENTE



ALU ALLOY

204408 ROUGE ROSSO



***HONDA XR**

204315 TRANSPARENT TRASPARENTE
204317 CARBON / TRANSPARENT



EYE (LED)

FEU + CLIGNOTANTS
FARO + FRECCIE
204421



***21.8008**

204266 CHROME / TRANSPARENT
CROMO / TRASPARENTE



***PEUGEOT 103**

S274200



SOUPLE SOFT

204310 ROUGE ROSSO



***TY 125**

204311 ROUGE ROSSO



ECLAIRAGE DE PLAQUE

LIGHTING OF LICENSE PLATE

HOMOLOGUÉ OMOLOGATO

204600 CHROME CROMO
204600B CARBONE STYLE CARBONIO
204600C NOIR MAT NERO OPACO



DIAMAND

HOMOLOGUÉ OMOLOGATO
204313 BLANC BIANCO
204313A ROUGE ROSSO



BARRETTE BROOCH

HOMOLOGUÉ OMOLOGATO
204425 + SUPPORT + SUPPORTO
204426 FEU SEUL FARO SOLO (1)



FEU DOUBLE DOUBLE LAMP

204312 + SUPPORT DE PLAQUE
+ SUPPORTO



SUPPORT DE PLAQUE

HOMOLOGUÉ OMOLOGATO
541300 ROUGE ROSSO
541300A BLANC BIANCO



**SUPPORT LATERAL PLAQUE
PORTATARGA**

541253 NOIR NERO



**PORTE PLAQUE + FEU LED NOEND
PORTATARGA NOEND**

541300B HOMOLOGUÉ OMOLOGATO



**PORTE PLAQUE AMOVIBLE NOEND
PORTATARGA NOEND**

541301

* Adaptable
* Adattabile

Les références du constructeur sont seulement indicatives et n'impliquent pas que les pièces de rechange viennent du constructeur.
I codici di riferimento originali sono indicativi e non implicano che i ricambi provengano necessariamente dalla stessa fabbrica del costruttore.

ECLAIRAGE LUCI

FEU ARRIERE SCOOTER FARO POSTERIORE SCOOTER

> TYPE ORIGINE ORIGINAL TYPE

TNT
Original



***BOOSTER 2004**
204324A HOMOLOGUÉ OMOLOGATO



***BOOSTER 2000 / BW'S 2000**
204324



***BOOSTER 2000 / BW'S 2000**
204323 HOMOLOGUÉ OMOLOGATO



***BOOSTER AM / BW'S AM**
204326



***NITRO / CPI / AEROX**
204318A HOMOLOGUÉ OMOLOGATO



***NITRO / AEROX 2013**
204318B HOMOLOGUÉ OMOLOGATO



***STRADA / ROMA 2/4T**
971165E GY6 HOMOLOGUÉ OMOLOGATO



***STUNT / SLIDER**
204323A HOMOLOGUE



***PIAGGIO ZIP 50**
206342A HOMOLOGUÉ OMOLOGATO



***PIAGGIO LX 50/125**
204416M HOMOLOGUÉ OMOLOGATO

> STYLE LEXUS

TNT
Tuning



***VIVACITY**
2043280



***BOOSTER/BW'S**
204328



***BOOSTER NEXT**
204328M



***BOOSTER / BW'S 2004**
204328K



***JOG-RR / MACH-G**
204328P



***LUDIX**
204328N

ECLAIRAGE LUCI FEU ARRIERE SCOOTER FARO POSTERIORE SCOOTER

> STYLE LEXUS

TNT
Tuning



***SPEEDFIGHT 2**
204328C



***TYPHOON**
204328H



***STUNT / SLIDER**
204328J



***PIAGGIO LX 50/125**
204416N HOMOLOGUÉ OMOLOGATO



***RUNNER 2003**
204328L



***SQUAB/TREKKER**
204328E



***SPEEDFIGHT 1**
204329B AVEC FIL ÉCLAIRANT
CON FILO ILLUMINATO

> STYLE LEXUS + LED TIPO LEXUS + LED

TNT
Tuning



***BOOSTER 2000 / BW'S 2000**
204416C HOMOLOGUÉ OMOLOGATO



***BOOSTER 2004 / BW'S 2004**
204416B



***BOOSTER 2004 / BW'S 2004**
204432A



***BOOSTER 2004 / BW'S 2004**
204417 BLANC BIANCO
204417A NOIR NERO



***LUDIX**
204416G HOMOLOGUÉ OMOLOGATO



***MACH-G**
204416K HOMOLOGUÉ OMOLOGATO



***NITRO / AEROX / CPI**
204432 ROUGE ROSSO



***NITRO / AEROX / CPI**
204416A HOMOLOGUÉ OMOLOGATO

* Adaptable
* Adattabile

Les références du constructeur sont seulement indicatives et n'impliquent pas que les pièces de rechange viennent du constructeur.
I codici di riferimento originali sono indicativi e non implicano che i ricambi provengano necessariamente dalla stessa fabbrica del costruttore.

ECLAIRAGE LUCI

FEU ARRIERE SCOOTER FARO POSTERIORE SCOOTER

> STYLE LEXUS + LED TIPO LEXUS + LED



***SR 50 2003**

204416I HOMOLOGUÉ OMOLOGATO



***NITRO/AEROX LED**

204318C CON FRECCHE



***SPEEDFIGHT 2**

204416F HOMOLOGUÉ OMOLOGATO



***STUNT / SLIDER**

204416E HOMOLOGUÉ OMOLOGATO



***NRG POWER**

204326A

> MAXI SCOOTER



***YAMAHA TMAX 500 2008-2011**

204361I HOMOLOGUÉ OMOLOGATO



***YAMAHA TMAX 530**

204361C HOMOLOGUÉ OMOLOGATO



***YAMAHA TMAX 530 FUMÉ**

204361G HOMOLOGUÉ OMOLOGATO

> CRISTAL / NOIR NERO / CRISTAL



***BOOSTER / BW'S 2000**

204419



***BOOSTER NEXT**

204419D



***BOOSTER / BW'S 2004**

204419B



***BOOSTER 2004>**

204432B AVEC CLIGNOTANTS

HOMOLOGUÉ OMOLOGATO



***NITRO / AEROX**

204419A



***MACH-G / JOG-R**

204419C

> FEU ARRIERE 50^{CC} A BOITE FARO POST. 50CC A MARCE



*** DERBI SENDA (LED)**

204433 TRANSP / ROUGE ROSSO
HOMOLOGUÉ OMOLOGATO



***DERBI SENDA**

204433A A DIODE + CLIGNO
DIODE CON FRECCHE



*** DERBI SENDA R**

204319 TRANSP. / ROUGE ROSSO



*** XP6 / XR6 / SENDA**

204328F TYPE LEXUS



*** XP6 / XR6 / SENDA (LED)**

204416D TYPE LEXUS

HOMOLOGUÉ OMOLOGATO

ECLAIRAGE LUCI

CABOCHON FEU ARRIERE GEMME FARO POSTERIORE



***BOOSTER AM / BW'S AM**
206600 TRANSPARENT



***BOOSTER 2000 / BW'S 2000**
206601 TRANSPARENT



***BOOSTER 2004 / BW'S 2004**
206601A TRANSPARENT



***NITRO / AEROX**
206603 TRANSPARENT



***NITRO / AEROX 2013**
206603A TRANSPARENT



***JOG / MACH-G**
206253 TRANSPARENT



***NEXT** TOUS MODELES ALL MODELS
206602 TRANSPARENT



***OVETTO / NEOS 2007**
206605A TRANSPARENT



***OVETTO / NEOS**
206605 TRANSPARENT



***FOX**
206619 TRANSPARENT



***BUXY**
206608 TRANSPARENT



***SQUAB / TREKKER**
206618 TRANSPARENT



***STALKER**
206607 TRANSPARENT



***STUNT / SLIDER**
206622 TRANSPARENT



***XFIGHT**
206615 TRANSPARENT



***VIVACITY**
206617 TRANSPARENT



***LUDIX**
206608A TRANSPARENT



***NRG EXTREME**
206616 TRANSPARENT

* Adaptable
* Adattabile

Les références du constructeur sont seulement indicatives et n'impliquent pas que les pièces de rechange viennent du constructeur.
I codici di riferimento originali sono indicativi e non implicano che i ricambi provengano necessariamente dalla stessa fabbrica del costruttore.

ECLAIRAGE LUCI

CABOCHON FEU ARRIERE GEMME FARO POSTERIORE

TNT
Tuning



***NRG**
206252 TRANSPARENT



***SCARABEO / RS 2002**
206623 TRANSPARENT



***HONDA SH 150**
206624 TRANSPARENT



***TYPHOON**
206606 TRANSPARENT



***LIBERTY 50**
206341A TRANSPARENT



***RUNNER**
206251 TRANSPARENT



***APRILIA SR 2006**
206620A TRANSPARENT



***BOOSTER / BW'S**
204327A TRANSPARENT



***SEDA / MALAGUTI F12**
206610 TRANSPARENT

> CABOCHON TYPE ORIGINE GEMME TIPO ORIGINALE

TNT
Original



***BOOSTER 2000 / BW'S 2000**
206214 ROUGE ROSSO



***NITRO / AEROX**
206523 ROUGE ROSSO



***OVETTO / NEOS**
206524 TRANSP. / ROUGE ROSSO



***FOX**
204308 ROUGE ROSSO



***SEDA**
206250 ROUGE ROSSO

ECLAIRAGE LUCI CABOCHON CLIGNOTANT GEMME FRECCE



***BOOSTER / BW'S** X4
206320 TRANSPARENT



***BOOSTER 2000 / BW'S 2000** X4
206334 TRANSPARENT



***BOOSTER 2004 / BW'S 2004** X4
206320A TRANSPARENT



***NITRO / AEROX** X4
206324 TRANSPARENT



***NITRO / AEROX 99** X4
206336 TRANSPARENT



***NITRO / AEROX 2013** X4
206336A TRANSPARENT



***NEXT** X4
206321 TRANSPARENT



***NEXT 99** X4
206335 TRANSPARENT



***OVETTO / NEOS** X4
206325 TRANSPARENT



***STUNT / SLIDER** X4
206337 TRANSPARENT



***STUNT / SLIDER NM** X4
206337A TRANSPARENT



***BUXY** X4
206323 TRANSPARENT



***SPEEDFIGHT 2** X4
206327 TRANSPARENT



***LUDIX / XP6** X4
206323A TRANSPARENT



***SQUAB / FOX** X4
206328 TRANSPARENT



***STALKER** X4
206333 TRANSPARENT



***VIVACITY** X4
206293 TRANSPARENT



***NRG / NTT** X4
206332 TRANSPARENT



***NRG EXTREME** X4
206338 TRANSPARENT



***RUNNER** X4
206319 TRANSPARENT



***RUNNER 2003** X4
206340 TRANSPARENT

* Adaptable
* Adattabile

Les références du constructeur sont seulement indicatives et n'impliquent pas que les pièces de rechange viennent du constructeur.
I codici di riferimento originali sono indicativi e non implicano che i ricambi provengano necessariamente dalla stessa fabbrica del costruttore.

ECLAIRAGE LUCI CABOCHON CLIGNOTANT GEMME FRECCE

TNT
Tuning



***RUNNER** X6
206339 TRANSPARENT



***TYPHOON** X4
206322 TRANSPARENT



***TYPHOON 2006** X4
206322A TRANSPARENT



***SR 2000** X4
206291 TRANSPARENT



***SR 2006** X4
206326A TRANSPARENT



***SR** X4
206326 TRANSPARENT



***PIAGGIO ZIP 50** X2
206341B TRANSPARENT



***LIBERTY 50** X4
206341 TRANSPARENT



***STEALTH** X4
206330 TRANSPARENT



***RS 2000 / SCARABEO** X4
206331 TRANSPARENT



***RS 97 / RX / MX** X4
206331A TRANSPARENT



***F12 2006** X4
206290A TRANSPARENT



***F12** X4
206290 TRANSPARENT



***SKYLINER 99** X4
206318 TRANSPARENT



***SKYLINER 2002** X4
206318A TRANSPARENT



***SENDA < 2000** X4
206329 TRANSPARENT

> TYPE ORIGINE TIPO ORIGINALE

TNT
Original



***PIAGGION ZIP 50**
204302 LA PAIRE PAIR



***BUXY AVANT ANTERIORE**
206216 DROIT RIGHT
206215 GAUCHE LEFT



***TYPHOON AVANT ANTERIORE**
206220 GAUCHE LEFT
206221 DROIT RIGHT



***TYPHOON ARRIERE POSTERIORE**
206222 GAUCHE LEFT
206223 DROIT RIGHT

ECLAIRAGE LUCI CLIGNOTANT A AMPOULE FRECCE A LAMPADINA

TNT
Tuning



LEXUS STYLE X2
HOMOLOGUÉ OMOLOGATO
206000 NOIR NERO
206000A STYLE CARBONE CARBONIO



SPHERA X2
HOMOLOGUÉ OMOLOGATO
206001 NOIR NERO
206001A STYLE CARBONE CARBONIO



DEMON 21W X2
HOMOLOGUÉ OMOLOGATO
206100 STYLE CARBONE CARBONIO



ARROLD X2
HOMOLOGUÉ OMOLOGATO
206002 NOIR NERO
206002A STYLE CARBONE CARBONIO
206002D CHROME CROMO



PEAK X2
HOMOLOGUÉ OMOLOGATO
206005 NOIR NERO
206005D STYLE CARBONE CARBONIO



TWIN 21W & 10W X2
OPTIQUE TRANSPARENTE VETRI TRASPARENTI
206197 NOIR NERO



21W & 10W X2
OPTIQUE TRANSPARENTE VETRI TRASPARENTI
206164 STYLE CARBONE CARBONIO



R1 21W & 10W X2
OPTIQUE TRANSPARENTE VETRI TRASPARENTI
206137 CHROME CROMO
206140 STYLE CARBONE CARBONIO



DEMON 21W & 10W X2
OPTIQUE TRANSPARENTE VETRI TRASPARENTI
206145 STYLE CARBONE CARBONIO
206146 NOIR NERO
206146A BLANC BIANCO
206149 CHROME CROMO



OVALIA 21W & 10W X2
OPTIQUE TRANSPARENTE VETRI TRASPARENTI
206131 BLANC BIANCO
206132 CHROME CROMO
206133 BLEU ANODISE BLU ANODIZZATO
206135 STYLE CARBONE CARBONIO



21W & 10W X2
STYLE CARBONE CARBONIO
206150 OPTIQUE FUMÉE FARI SOLARE
206157 OPTIQUE TRANSPARENTE VETRI TRASPARENTI
CHROME CROMO
206163 OPTIQUE TRANSPARENTE VETRI TRASPARENTI

* Adaptable
* Adattabile

Les références du constructeur sont seulement indicatives et n'impliquent pas que les pièces de rechange viennent du constructeur.
I codici di riferimento originali sono indicativi e non implicano che i ricambi provengano necessariamente dalla stessa fabbrica del costruttore.

ECLAIRAGE LUCI CLIGNOTANT A AMPOULE FRECCE A LAMPADINA

> TYPE ORIGINE TIPO ORIGINALE

TNT
Original



ARRIERE POSTERIORE
***BOOSTER *NITRO / AEROX < 2013** X2
AVANT ANTERIORE
***BOOSTER *NITRO / AEROX NAKED < 2013** X2
206301B HOMOLOGUÉ OMOLOGATO



***NITRO / AEROX < 2013** X2
206301A HOMOLOGUÉ OMOLOGATO



***BOOSTER 2004 AVANT ANTERIORE** X2
206301C HOMOLOGUÉ OMOLOGATO



***BOOSTER 2004 ARRIERE POSTERIORE** X2
206301D HOMOLOGUÉ OMOLOGATO



***PIAGGIO LX 50/125 ARRIERE POSTERIORE** X2
204360H HOMOLOGUÉ OMOLOGATO



***PIAGGIO LX 50/125 AVANT ANTERIORE** X2
204360F HOMOLOGUÉ OMOLOGATO



***PIAGGIO PRIMAVERA** X2
HOMOLOGUÉ OMOLOGATO
204360J ARRIERE POSTERIORE



***PIAGGIO PRIMAVERA** X2
HOMOLOGUÉ OMOLOGATO
204360K AVANT ANTERIORE



***YAMAHA STUNT/SLIDER** X2
HOMOLOGUÉ OMOLOGATO
206301E AVANT ANTERIORE

> TYPE ORIGINE TIPO ORIGINALE

RD
MAX



***YAMAHA TMAX 530** X2
HOMOLOGUÉ OMOLOGATO
204361B ARRIERE POSTERIORE



***YAMAHA TMAX 530** X2
HOMOLOGUÉ OMOLOGATO
204361A AVANT ANTERIORE



***YAMAHA TMAX 2008-2011** X2
HOMOLOGUÉ OMOLOGATO
204361 AVANT ANTERIORE



***YAMAHA TMAX 530** X2
HOMOLOGUÉ OMOLOGATO
204361E AVANT ANTERIORE



***YAMAHA TMAX 530** X2
HOMOLOGUÉ OMOLOGATO
204361F ARRIERE POSTERIORE

ECLAIRAGE LUCI CLIGNOTANT A LED FRECCES CON LED

TNT
Tuning



DELTA X2
HOMOLOGUÉ OMOLOGATO
206022 NOIR NERO



AERO X2
HOMOLOGUÉ OMOLOGATO
206022A NOIR NERO



BOOMERANG X2
HOMOLOGUÉ OMOLOGATO
206022C NOIR NERO



ARROW X2
HOMOLOGUÉ OMOLOGATO
206022B NOIR NERO



BEAN X2
HOMOLOGUÉ OMOLOGATO
206022D NOIR NERO



TWICE X2
HOMOLOGUÉ OMOLOGATO
206020 NOIR NERO
206020A STYLE CARBONE CARBONIO



CRISPY X2
HOMOLOGUÉ OMOLOGATO
206022E NOIR NERO



APACHE X2
HOMOLOGUÉ OMOLOGATO
206022F NOIR NERO



CLINTON X2
HOMOLOGUÉ OMOLOGATO
206022J NOIR NERO



DROPE X2
HOMOLOGUÉ OMOLOGATO
206022G NOIR NERO



TRUMP X2
HOMOLOGUÉ OMOLOGATO
206022I NOIR NERO



TROOP X2
HOMOLOGUÉ OMOLOGATO
206022H NOIR NERO



CYCLOPS X2
HOMOLOGUÉ OMOLOGATO
206011 NOIR NERO
206011A CHROME CROMO



CENTRALE CLIGNOTANT ELECTRONIQUE UNIVERS.
RELAY UNIVAL TO FIT LEDS INDICATORS
206174



RESISTANCES POUR CLIGNOTANT A LEDS
RESISTANCES FOR LEDS
206175 LEDS 10W X2 (1)
206175A LEDS 21W X2

* Adaptable
* Adattabile

Les références du constructeur sont seulement indicatives et n'impliquent pas que les pièces de rechange viennent du constructeur.
I codici di riferimento originali sono indicativi e non implicano che i ricambi provengano necessariamente dalla stessa fabbrica del costruttore.

ECLAIRAGE LUCI

FEU DECORATIF LUCI TUNING

> CLIGNOTANT A MONTAGE DIVERS



X2

STYLE CARBONE CARBONIO

206151 OPTIQUE FUMÉE VETRI SOLARE

206155 OPTIQUE NACRÉE VETRI ZIGRINATI



X2

206185 OPTIQUE TRANSPARENTE VETRI TRASPARENTI



X2

206180 OPTIQUE TRANSPARENTE ETRI TRASPARENTI



X2

MICRO

206183 OPTIQUE TRANSPARENTE ETRI TRASPARENTI

> FEU DECORATIF LUCI TUNING



PERL

X2

220360 CHROME BLANC CROMO BIANCO

220362 STYLE CARBONE BLANC CARBONIO BIANCO



X2

DIAMANT

206188 CHROME CROMO

206190 STYLE CARBONE CARBONIO



CLIGNOTANT A LEDS

X2

220371A ROUGE ROSSO

> NEON NEON

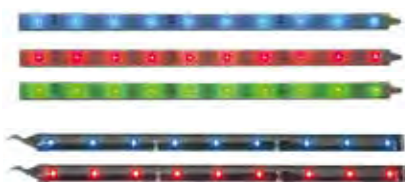

	25 cm	32 cm	40 cm
BLEU BLU	220375	220376	220377
ROUGE ROSSO	220375A	220376A	220377A
VERT VERDE	220375B	220376B	220377B
BLANC BIANCO	220375F	220376F	220377F
FOND NOIR NERO			
BLEU BLU	220375D	220376D	220377D
ROUGE ROSSO	220375E	220376E	220377E
BLANC BIANCO	220375G	220376G	220377G



TUBES TUBI

X2

220410 LED BLEU LED BLU



METEOR SHOWER

6"/ 15 cm

BLEU BLU 220400C

ROUGE ROSSO 220401C



TUBES NEON TUBI NEON

X2

6"/ 15 cm 9"/ 23 cm 12"/ 30 cm

BLEU BLU 220400 220400A 220400B

ROUGE ROSSO 220401

FREINAGE

- > MACHOIRES DE FREIN
- > PLAQUETTES DE FREIN
- > FREIN A DISQUE
- > COUVERCLE DE MAITRE CYLINDRE
- > FREIN A PIED

FRENI

- > GANASCE
- > PASTIGLIE FRENO
- > FRENI A DISCO
- > COPERCHI POMPA FRENO
- > PEDALINE FRENO

FREINAGE FRENI MACHOIRES DE FREIN GANASCE

TNT
Original



280600



280601



280610

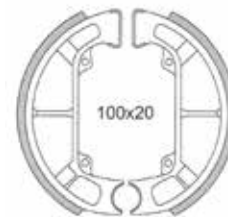

280621

Cyl. Cil.	Modèle Modello	Année Anno	Av. Ant	Ar. Post	Réf. Codice
-----------	----------------	------------	---------	----------	-------------

50	Amigo	92>96		▲	-
50	Gulliver	95>		▲	-
50	Rally	-95		▲	-
50	Scarabeo 1	93>	●	▲	-
50	Scarabeo	94		▲	-
50	Scarabeo	95		▲	-
50	Scarabeo	00>04		▲	-
50	Street	00>04		▲	-
50	SONIC	97>		▲	-
50	SR	98>96		▲	-
70	SCARABEO	94		▲	-
100	SCARABEO	00>		▲	280624
ATALA					
50	Carosello	97>		▲	280610
BENELLI					
50	K2 Liquid	98>01		▲	280610
50	491 Gt Sport	97>		▲	-
50	491 St Morini	03		▲	-
50	NAKED	02>04		▲	-
50	Naked Morini	n/a		▲	-
50	PEPE LX	99>04		▲	-
BETA					
50	Ark Lc Ruote Raggi	96>		▲	280610
50	Ark Aria	96>		▲	-
50	CH	96>		▲	-
50	Chrono	92>94		▲	-
50	Quadra Chrono 502	95>99		▲	-
50	Tempo	94>95		▲	-
50	Tempo 13	96>99		▲	-
50	Tempo 16	96>99		▲	-
BRANDY-BRAS					
50	Brandy	n/a		▲	280601
90	Brandy	n/a		▲	-
BS VILLA					
50	AX - GZ	93>		▲	290610
CPI					
50	Baby J	02>		▲	280600
50	Hussar	01>02		▲	-
50	Hussar	03>05		▲	-
50	Mars	01>02		▲	-
50	Oliver	03>05		▲	-
50	Popcorn	02>		▲	-
CAGIVA					
50	City	92>94		▲	290610
50	City	95>		▲	-
FANTIC					
50	Pony	93>	●	▲	280601
50	Pony SR	93>	●	▲	-
50	Quennie	95>	●	▲	-
GILERA					
50	Easy moving	95>		▲	280621
50	Eaglet	96		▲	280622
50	Runner	97>05		▲	-
50	Storm	94>		▲	280621
50	Typhoon	93>95		▲	280621
50	Typhoon	96>		▲	280623
80	Typhoon	95>	●	▲	280621
125	Typhoon	95>	●	▲	280622
125	Typhoon Xr Kat	00	●	▲	-

Cyl. Cil.	Modèle Modello	Année Anno	Av. Ant	Ar. Post	Réf. Codice
-----------	----------------	------------	---------	----------	-------------

50	Limbo	93>		▲	-
50	Samba SR	93>	●	▲	-
80	Samba SR	93>		▲	280610
125	Samba SR	93>		▲	-
HONDA					
50	C-Z2 Tutti-CF-Chaly	75>	●	▲	280610
50	Dax	93>	●	▲	-
50	Monkey	88>		▲	-
50	NH Lead	97>94	●		-
50	PK Wallaroo DX-STD	90>		▲	-
50	QA K1-3	87>	●	▲	-
50	SFX-FX	95>		▲	-
50	SH	97>		▲	-
50	SH Fifty	97>		▲	-
50	SJ Baly	93>		▲	-
50	SKY - Vetro	97>00		▲	-
50	SS ZK2	75>77	●	▲	-
50	ST-ST Dax	78>93>	●	▲	-
100	SJ Bali	98>		▲	-
100	Supra	>98	●	▲	-
100	Supra	99>		▲	-
125	Dylan	02		▲	280625
125	MTX R - Rally Sport	86>89		▲	280610
125	Nes Chiocciola	00>		▲	280625
125	NH-H-Lead 83	83>87	●	▲	280610
125	NH-Lead	88		▲	-
125	NSF	85		▲	-
125	NS-F-R-Super Sport	85>87		▲	-
125	NX	90		▲	-
125	SH	00>		▲	280625
125	XL-R-S	84	●	▲	280610
200	XL-R2 -Paris Darkar	85>87		▲	-
125	XL L -Paris Dakar -R2	85>87		▲	-
125	XL -Paris Dakar	84>85	●	▲	-
150	Nes Chiocciola			▲	280625
150	SH	02		▲	-
200	MTX R - XLR	85>87		▲	280610
200	XL R -Paris Dakar	83>84	●	▲	-
200	XL-R2 -Paris Darkar	85>87		▲	-
n/a	VT Shadow	98>		▲	-
KTM					
50	Chrono	94>		▲	280610
50	Go	94>		▲	-
KYMCO					
50	B&W - Euro 2	02>03		▲	280610
50	Curio	94		▲	-
50	Dink - Classic Euro 2	98>03		▲	-
50	DJX - DJY - DJW	91>00	●		-
50	Fever ZX Euro 2	99>04		▲	-
50	Filly	98	●	▲	280610
50	Filly LX	01>02		▲	-
50	Heroism	95>97		▲	-
50	K12 - KB	95>00		▲	-
50	Refined	94	●	▲	-
50	Top Boy	97>00		▲	-
50	Vitality- EU 2	02>04	●	▲	-
100	Top Boy	n/a		▲	-
125	Freeway	97	●	▲	-
125	Heroism	95>97		▲	-

Cyl. Cil.	Modèle Modello	Année Anno	Av. Ant	Ar. Post	Réf. Codice
-----------	----------------	------------	---------	----------	-------------

MALAGUTI					
50	Centro Base	93>94			280610
50	Centro SL - Kat	94>00			-
50	Ciak	98>00			-
50	Ciak Mono Euro 2,3	03>04			-
50	F10	92>93			-
50	F10	94>95			-
50	F10 Jet Line - Kat	96>00			-
50	F10 Restyling EU 2,3	01>06			-
50	F12 EU 1,2,3	99>06			-
50	F12 LC	94>98			-
50	F12 LC - Aaria	94>98		▲	-
50	F15 Firefox	96>98		▲	-
n/a	F15 Firefox Air	05/09		▲	-
50	Yesterday- Euro	97>00		▲	-
MBK					
50	Active	90>	●		280600
50	Booster	90>04	●	▲	-
50	Booster NG	95>98		▲	-
50	Booster R	94>		▲	-
50	Booster Road	>94	●	▲	-
50	Booster Rocket	97>98		▲	-
50	Booster Spirit	96>		▲	-
50	Booster Spirit	13	●		280601A
50	Booster Track	96>98		▲	-
50	Booster Road	94>95		▲	280601
50	Booster NG-EU 1	99>03		▲	-
50	Booster Spirit-EU 2	96>03		▲	-
50	CRZ Target	91>95		▲	-
50	CTS-CT SS- Sorriso	91>95	●	▲	-
50	CWL-Booster	01>04		▲	-
50	Doodo	00>		▲	280624
50	Evolis	92		▲	280601
50	Fizz	94>98		▲	280600
50	Flipper Kat-Mach G E1,2	99>04		▲	280601
50	Flipper	94>98		▲	280600
50	Forte	94>98		▲	-
50	Ne Sorriso	95>96	●	▲	280601
50	Ovetto EU1 EU2	97>04		▲	-
50	Ovetto One	13	●		280601A
50	Stunt	00>02		▲	-
75	Active	90>	●		280600
80	Active	90>	●		-
100	Booster	99>		▲	280624
125	Doodo	00>01		▲	-
125	Skyliner	98>01		▲	-
150	Doodo	01>		▲	280624
150	Skyliner	>01		▲	-
MOTRON					
50	Spyke-Sting	95>97		▲	280610
50	Syncro-Thunder	93>94		▲	-
PGO					
50	Star-Star2	>93	●		280610
50	Star2	94>	●		-
80	Big Max-Star	90>	●		-
PEUGEOT					
50	ASV	93		▲	280610
50	Buxy	94>97		▲	-
50	Buxy RS	94>		▲	-

FREINAGE FRENI MACHOIRES DE FREIN GANASCE

TNT
Original



280622

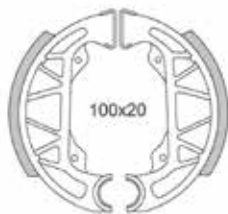

280623



280624



280625

Cyl. Cil.	Modèle Modello	Année Anno	Av. Ant	Ar. Post	Réf. Codice
50	Elyseo	98		▲	-
50	Elyseo	99		▲	-
50	Fox	94>98		▲	-
50	Looxor - TSDI	01>02		▲	-
50	Ludix 10 One	04		▲	-
50	Ludix 10 Trend-Snake	04		▲	-
50	Ludix 14 Classic	04		▲	-
50	Ludix 14 Elegant	04		▲	-
50	Metal-X	02		▲	-
50	Metropolis	n/a	●		-
50	SC- SX	n/a	●		-
50	Scotelec	98>99	●	▲	-
50	Speeddake	95>97		▲	-
50	Speeddale	95>97		▲	-
50	Speedfight Acqua AJP	97>98		▲	-
50	Speedfight Acqua H.T	97>98		▲	-
50	Speedfight KAT Aria	99		▲	-
50	Speedfight KAT Aria	97>99		▲	-
50	Squab	95>97		▲	-
50	Squab	95		▲	-
50	Squab Heng Tong	n/a		▲	-
50	SV APS System	91	●	▲	-
50	SV Geo	92		▲	-
n/a	SV Geo	91-92		▲	-
n/a	SV Geo	93		▲	-
50	SV Geo - L	93		▲	-
50	SV J Juinior	93	●	▲	-
50	SV Rolland Garros-Sport	93		▲	-
50	SV T	93		▲	-
50	Trekker OFF Road AJP	97>00		▲	-
50	Vivacity Spec.Sport Line	02		▲	-
50	Vivacity spec.-X Race	02		▲	-
50	Vivacity VS-X Speciali	02		▲	-
50	Vivacity-KAT-AJP	99>02		▲	-
50	Vivacity-Heng Tong	99>02		▲	-
50	X Fight Aria	00		▲	-
50	X Fight Aria Heng Tong	00		▲	-
50	Zenith	92		▲	-
50	Zenith L. Grimeca	94>96		▲	-
50	Zenith LN - LS	97>98		▲	-
50	Zenith N	97>98	●	▲	-
75	SC-SX	n/a	●		-
80	Metropolis - SC	n/a	●		-
80	SV Executive	96>		▲	280610
80	SX	n/a	●		-
100	Elyseo	99>01		▲	-
100	SVL	97		▲	-
100	Trekker AJP	98		▲	-
100	Trekker Heng Tong	98		▲	-
100	Vivacity AJP	99>01		▲	-
100	Vivacity Heng Tong	99>02		▲	-
125	SV Geo	91>92		▲	-
125	SV Geo - Executive	93>		▲	-
PIAGGIO					
50	Free	96>		▲	280621
50	Free	96>		▲	280623
50	Nrg	94>95		▲	280621
50	Nrg	96>		▲	280623
50	Nrg MC2	96>		▲	-
50	Ntt	>95		▲	280621
50	Ntt	96>		▲	280623

Cyl. Cil.	Modèle Modello	Année Anno	Av. Ant	Ar. Post	Réf. Codice
50	Quartz	92>		▲	280621
50	Sfera	91>		▲	-
50	Sfera RST	95>		▲	280623
50	Typhoon	n/a		▲	280622
50	Velofax	96	●		-
50	Vespa ET2	97>		▲	-
50	Vespa ET4	99>		▲	-
50	Vespa LX 2T	05>		▲	-
50	Vespa LX 4T	05>		▲	-
50	Zip	92>93		▲	280621
50	Zip	99>		▲	280622
50	ZIP FAST RIDER	95>		▲	-
50	Zip Fast Rider	93>95		▲	280623
50	Zip RST	96>97		▲	280622
50	Zip SP	96>		▲	-
80	Sfera	94>		▲	280621
125	Hexagon	94>		▲	280622
125	Sfera	95>		▲	-
125	Sfera 4T	96>		▲	-
125	Skipper	93>97		▲	-
125	Vespa ET4	96>		▲	-
125	Vespa LX	05>		▲	-
125	Zip	00>		▲	-
150	Hexagon	94>99		▲	-
150	Skipper	93>97		▲	-
150	Vespa ET4	96>		▲	-
150	Vespa LX	05>		▲	-
SYM					
50	Cinderella	99>		▲	280610
50	City Hopper	99>		▲	-
50	Fancy-Super Fancy	95>99		▲	-
50	Fiddle	99>	●		-
50	Jet	95>		▲	-
50	Jungle	99>		▲	-
50	Red Devil	99>		▲	-
100	Cinderella - Super Fancy	99>		▲	-
125	Super Duke	99>		▲	-
YAMAHA					
50	Beeluga	90>	●		280600
50	Axis	95>96		▲	280601
50	Axis	93>94		▲	280610
50	Breeze	94>95		▲	280601
50	BW'S Road	91	●	▲	280600
50	BW'S Next Generation	97>98		▲	280600
50	BW'S Next Generation	99>04		▲	280601
50	BW'S Orig. EU2-CW	02		▲	-
50	BW'S Original Bump	91>02		▲	-
50	BW'S Original EU2	03		▲	-
50	BW'S-R-Bump-Naked	97>04		▲	-
50	CRZ CR Target	91>95	●	▲	-
50	CTS CT Super Sport	90>95	●	▲	-
50	CW RS SPY	95>98		▲	-
50	DT-R	98>		▲	280600
50	DT-R	93>		▲	-
50	EW Slider	00>02		▲	280601
50	Grafix	93>	●	▲	280600
50	Joc	90>	●	▲	-
50	Jog	90		▲	-
50	Nrg MC2	93		▲	280601
50	Jog R - Euro 2	02>04		▲	-
50	Jog Z	95>96		▲	-

Cyl. Cil.	Modèle Modello	Année Anno	Av. Ant	Ar. Post	Réf. Codice
50	Trafix	93	●	▲	280600
50	Trunk	94		▲	280610
50	WHY-Euro 1-2	98>04		▲	280601
50	YE Zest	92		▲	-
50	YNR Neo'S-euro2	97>04		▲	-
50	Zuma	96		▲	280600
80	Beluga	89	●	▲	280601
80	DT	n/a	●	▲	280600
80	DT LC	89>		▲	-
80	PW	91>		▲	-
80	V	83>	●	▲	-
80	YFM Badger	92>01		▲	280624
100	BW'S	00>		▲	-
100	RX	83>	●	▲	280600
105	Crypton	98>		▲	-
125	Beluga	93>		▲	280624
125	Cygnus T	95>98	●		-
125	Drag Star	00>		▲	-
125	Riva XX	93>		▲	-
125	YBR	05>		▲	-
125	YFA Breeze	92>02		▲	-
150	Majesty	00		▲	-
180	Majesty R	03		▲	-
180	RT	93>94		▲	-
180	RT G,H	95>		▲	-
200	YFM 200	85>89		▲	-
250	250 S Virago	95>		▲	-
250	Drag Star	01>		▲	-
250	Soufultwin Renaisa	96>		▲	-

SCOOTER GY6 50cc 4T



TNT MOTOR					
50	Roma 2 & 3			▲	-

CYCLO CICLOMOTORE



MBK					
50	51 GRIMECA Ø 90 (1)				280230
PEUGEOT					
50	103 80 X 18 (2)				280210
50	103 GRIMECA Ø 90 (1)				280230
50	103 BERNADI Ø 90				280231

* Adaptable
* Adattabile

Les références du constructeur sont seulement indicatives et n'impliquent pas que les pièces de rechange viennent du constructeur.
I codici di riferimento originali sono indicativi e non implicano che i ricambi provengano necessariamente dalla stessa fabbrica del costruttore.

AS 251

FREINAGE FRENI PLAQUETTES DE FREIN PASTIGLIE FRENO

TNT Original 281910		SKY SARHANY 281000
---	--	--

***BUXY / BOOSTER / BWS / TYPHOON / SR** **ECHELLE SCALE 1/1**

6	Epaisseur Spessore	39,7	Largueur Larghezza	49,5	Hauteur Altezza
----------	-----------------------	-------------	-----------------------	-------------	--------------------

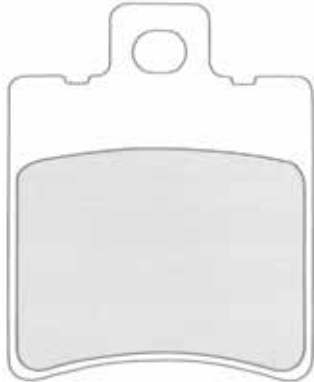

TNT Original 281911		SKY SARHANY 281000A
---	--	---

***SQUAB / DERBI / SPEEDFIGHT / FYM125** **ECHELLE SCALE 1/1**

6	Epaisseur Spessore	36	Largueur Larghezza	45,5	Hauteur Altezza
----------	-----------------------	-----------	-----------------------	-------------	--------------------

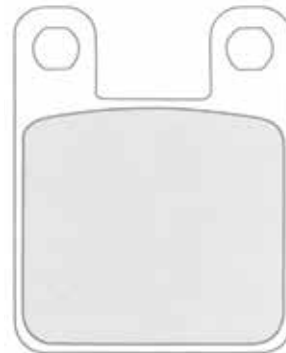

TNT Original 281948		SKY SARHANY 281018
---	--	--

***PEUGEOT / PGO** **ECHELLE SCALE 1/1**

A	6,5	Epaisseur Spessore	85	Largueur Larghezza	42,5	Hauteur Altezza
B	8,7	Epaisseur Spessore	47,4	Largueur Larghezza	37,1	Hauteur Altezza

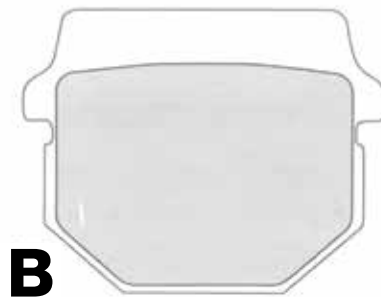
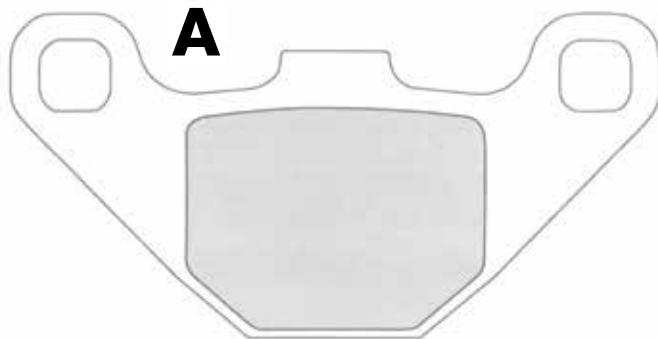

TNT Original 281930G		
--	--	--

***STRIKE AVANT ANTERIORE** **ECHELLE SCALE 1/1**

9	Epaisseur Spessore	60	Largueur Larghezza	44	Hauteur Altezza
----------	-----------------------	-----------	-----------------------	-----------	--------------------

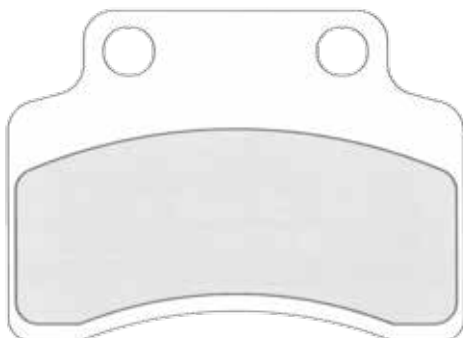

TNT Original 281949		
---	--	--

***ROMA 50 / BOOSTER100 / GY6** **ECHELLE SCALE 1/1**

7,3	Epaisseur Spessore	61	Largueur Larghezza	27,3	Hauteur Altezza
------------	-----------------------	-----------	-----------------------	-------------	--------------------



FREINAGE FRENI PLAQUETTES DE FREIN PASTIGLIE FRENO



*GILERA STALKER / ET4

ECHELLE SCALE 1/1

6,9 ✱ Epaisseur Spessore 35,5 ✱✱ Largeur Larghezza 49 ✱ Hauteur Altezza



*SCARABEO 125/200/250/400/500 AVANT ANTERIORE ECHELLE SCALE 1/1

9,3 ✱ Epaisseur Spessore 50,9 ✱✱ Largeur Larghezza 53,5 ✱ Hauteur Altezza

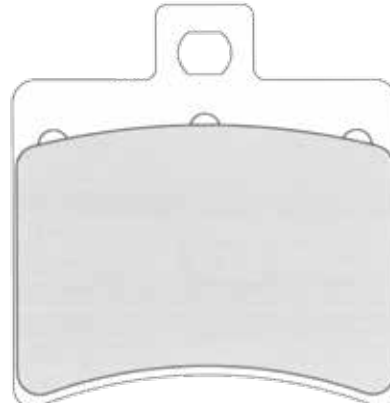

*APRILIA LEONARDO AVANT ANTERIORE GRIMECA

ECHELLE SCALE 1/1

7,3 ✱ Epaisseur Spessore 79 ✱✱ Largeur Larghezza 47 ✱ Hauteur Altezza

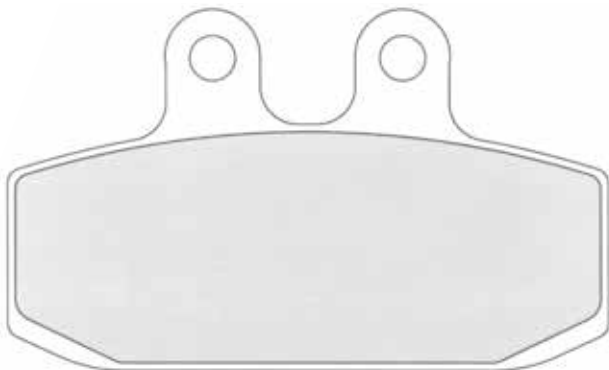

*APRILIA LEONARDO AVANT/ARRIERE ANT./POST. ECHELLE SCALE 1/1

7,8 ✱ Epaisseur Spessore 53,9 ✱✱ Largeur Larghezza 50,7 ✱ Hauteur Altezza



*APRILIA SCARABEO AVANT DROIT ANTERIORE DESTRA ECHELLE SCALE 1/1

A 7,5 ✱ Epaisseur Spessore 79 ✱✱ Largeur Larghezza 47,1 ✱ Hauteur Altezza
B 7,5 ✱ Epaisseur Spessore 79 ✱✱ Largeur Larghezza 47,1 ✱ Hauteur Altezza

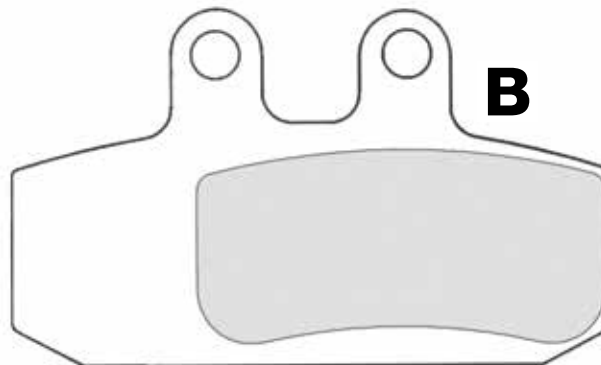
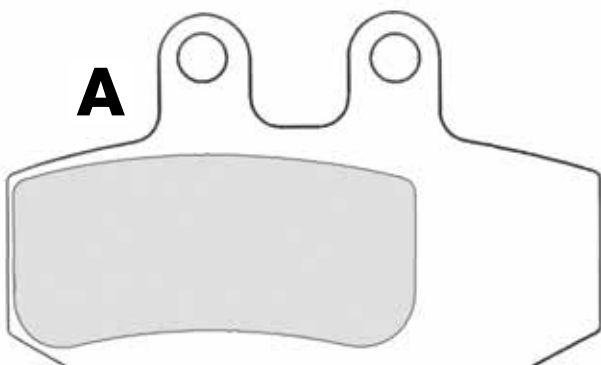

* Adaptable
* Adattabile

Les références du constructeur sont seulement indicatives et n'impliquent pas que les pièces de rechange viennent du constructeur.
I codici di riferimento originali sono indicativi e non implicano che i ricambi provengano necessariamente dalla stessa fabbrica del costruttore.

FREINAGE FRENI PLAQUETTES DE FREIN PASTIGLIE FRENO



***APRILIA RS ARRIERE POSTERIORE** **ECHELLE SCALE 1/1**

6	✱ Epaisseur Spessore	35,3	↔ Largeur Larghezza	51,5	⊕ Hauteur Altezza
----------	----------------------	-------------	---------------------	-------------	-------------------

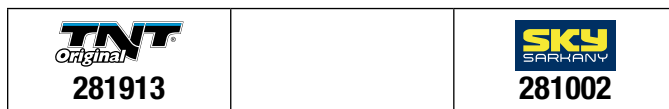

***APRILIA RS AVANT ANTERIORE** **ECHELLE SCALE 1/1**

7	✱ Epaisseur Spessore	39,8	↔ Largeur Larghezza	56,3	⊕ Hauteur Altezza
----------	----------------------	-------------	---------------------	-------------	-------------------



***PIAGGIO HEXAGON / DNA** **ECHELLE SCALE 1/1**

A	7,5	✱ Epaisseur Spessore	94,5	↔ Largeur Larghezza	42	⊕ Hauteur Altezza
B	7,5	✱ Epaisseur Spessore	77	↔ Largeur Larghezza	42	⊕ Hauteur Altezza

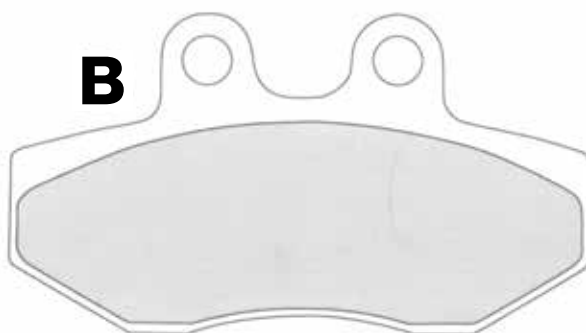
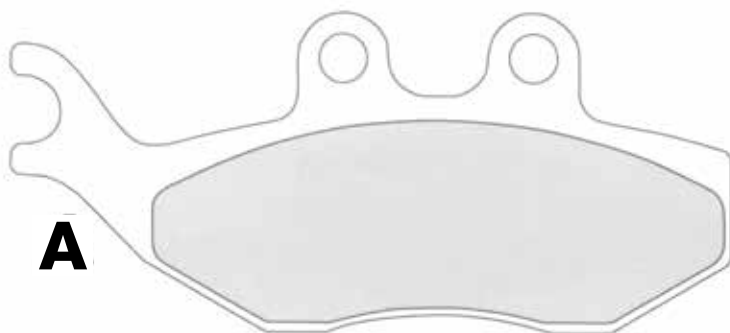

***PIAGGIO X8 AVANT / X9 AVANT - GAUCHE ANT.-SX** **ECHELLE SCALE 1/1**

A	9	✱ Epaisseur Spessore	96,7	↔ Largeur Larghezza	41	⊕ Hauteur Altezza
B	9	✱ Epaisseur Spessore	76,9	↔ Largeur Larghezza	41	⊕ Hauteur Altezza

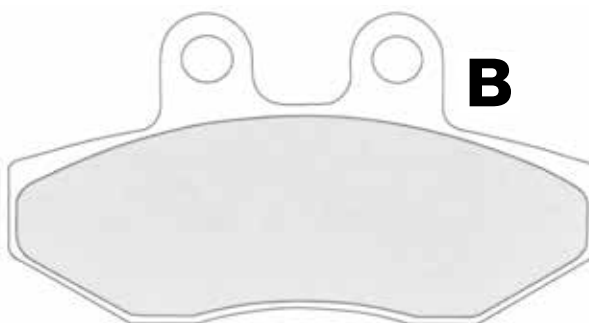
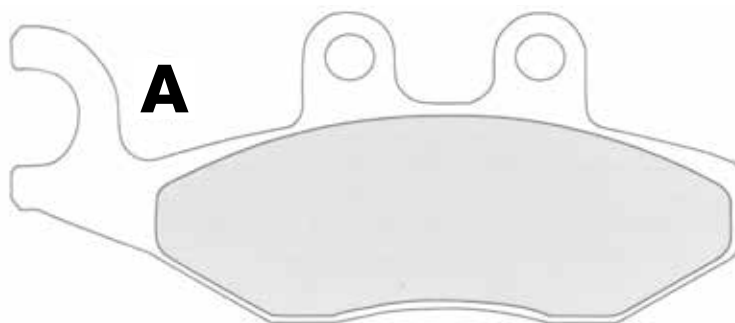

FREINAGE FRENI PLAQUETTES DE FREIN PASTIGLIE FRENO

TNT Original 281920A		
--	--	--

***PIAGGIO X8 / MP3 / XEVO 125 ARRIERE POSTERIORE ECHELLE SCALE 1/1**

8	✳ Epaisseur Spessore	55,4	↔ Largeur Larghessa	54,5	⬆ Hauteur Altezza
----------	-------------------------	-------------	------------------------	-------------	----------------------

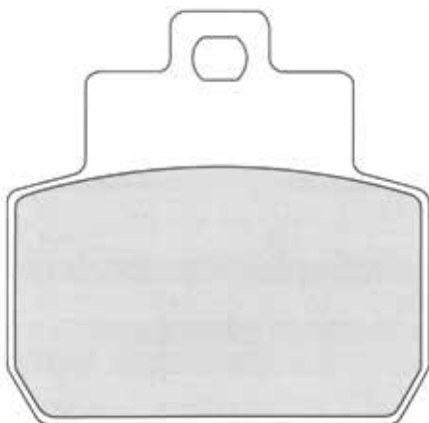

TNT Original 281920		SKY SARHANY 281006
---	--	--

***PIAGGIO X9 ARRIERE / X-MAX 125 ARRIERE POST. ECHELLE SCALE 1/1**

7,8	✳ Epaisseur Spessore	50,7	↔ Largeur Larghessa	53,8	⬆ Hauteur Altezza
------------	-------------------------	-------------	------------------------	-------------	----------------------



TNT Original 281930I		SKY SARHANY 281006C
--	--	---

***PIAGGIO X9 AVANT DROIT ANTERIORE DESTRA ECHELLE SCALE 1/1**

A	9	✳ Epaisseur Spessore	76,9	↔ Largeur Larghessa	41	⬆ Hauteur Altezza
B	9	✳ Epaisseur Spessore	96,7	↔ Largeur Larghessa	41	⬆ Hauteur Altezza

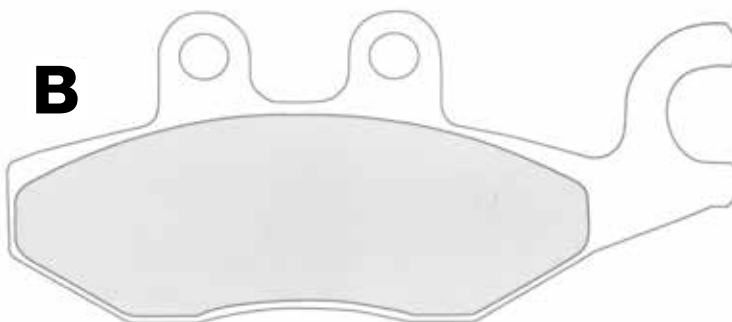

RB MAX 281917		SKY SARHANY 281004
-----------------------------------	--	--

***MBK SKYLINER / YAMAHA MAJESTY ECHELLE SCALE 1/1**

A	7,6	✳ Epaisseur Spessore	94	↔ Largeur Larghessa	36	⬆ Hauteur Altezza
B	7,6	✳ Epaisseur Spessore	94	↔ Largeur Larghessa	36	⬆ Hauteur Altezza

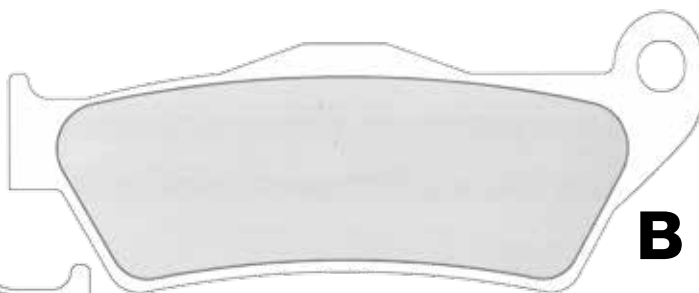
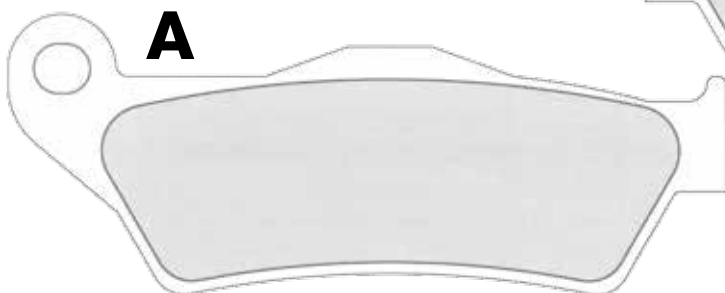

FREINAGE FRENI PLAQUETTES DE FREIN PASTIGLIE FRENO

TNT Original 281912		SKY SARKANY 281001
---	--	--

*MBK NITRO / AEROX ARRIERE POSTERIORE **ECHELLE SCALE 1/1**

6,4 ✱ Epaisseur Spessore	45,8 ✱✱ Largeur Larghessa	52,7 ✱✱ Hauteur Altezza
------------------------------------	-------------------------------------	-----------------------------------



TNT Original 281921		SKY SARKANY 281007
---	--	--

*MBK X-LIMIT AVANT ANTERIORE **ECHELLE SCALE 1/1**

5,5 ✱ Epaisseur Spessore	31,6 ✱✱ Largeur Larghessa	52 ✱✱ Hauteur Altezza
------------------------------------	-------------------------------------	---------------------------------



TNT Original 281921A		
--	--	--

* MBK X-LIMIT ARRIERE POSTERIORE **ECHELLE SCALE 1/1**

7 ✱ Epaisseur Spessore	49,8 ✱✱ Largeur Larghessa	47 ✱✱ Hauteur Altezza
----------------------------------	-------------------------------------	---------------------------------

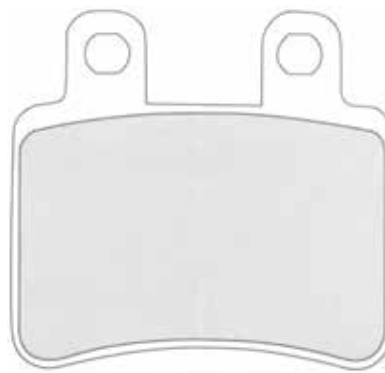

TNT Original 281919		
---	--	--

* MBK X-POWER **ECHELLE SCALE 1/1**

A 8,3 ✱ Epaisseur Spessore	96,6 ✱✱ Largeur Larghessa	42 ✱✱ Hauteur Altezza
B 8,3 ✱ Epaisseur Spessore	77 ✱✱ Largeur Larghessa	42 ✱✱ Hauteur Altezza

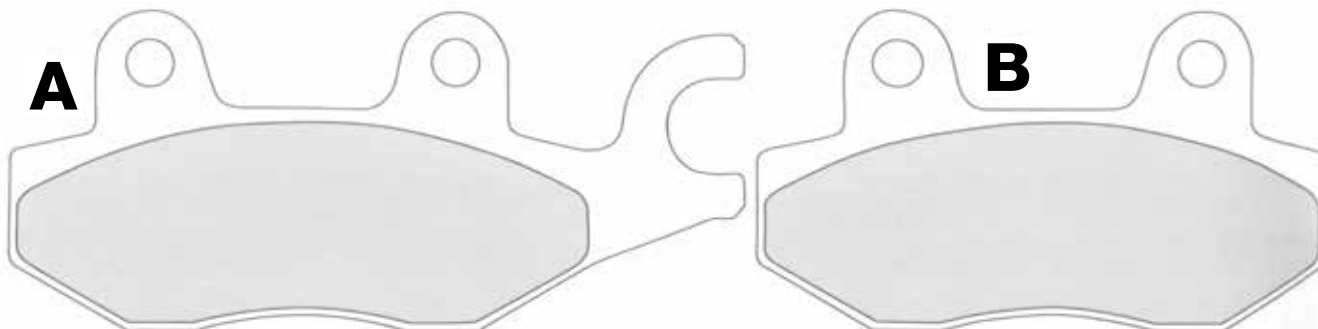

FREINAGE FRENI PLAQUETTES DE FREIN PASTIGLIE FRENO

TNT Original 281918		SKY SARHANY 281005
---	--	--

* MBK XPOWER / TZR 50 ARRIERE POSTERIORE ECHELLE SCALE 1/1

9 ✱ Epaisseur Spessore	71 ⇄ Largeur Larghezza	36,2 ⚡ Hauteur Altezza
-------------------------------	-------------------------------	-------------------------------

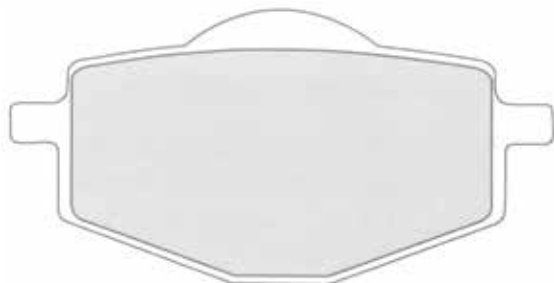

RD MAX 281917A		
------------------------------------	--	--

*YAMAHA MAJESTY / X-MAX / X-CITY 250 ARR. POST. ECHELLE SCALE 1/1

9 ✱ Epaisseur Spessore	99,8 ⇄ Largeur Larghezza	31 ⚡ Hauteur Altezza
-------------------------------	---------------------------------	-----------------------------

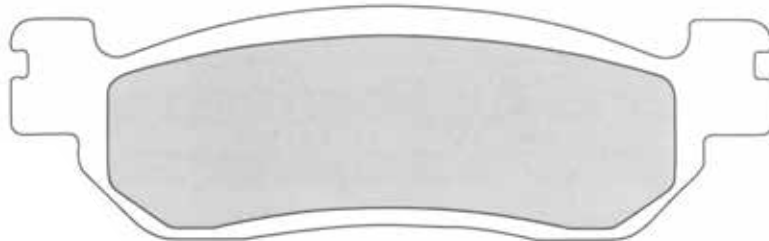

TNT Original 281917B		
--	--	--

*YAMAHA X-MAX 125 09 / SUZUKI BURGMAN 650 AVANT ECHELLE SCALE 1/1

10,5 ✱ Epaisseur Spessore	101,9 ⇄ Largeur Larghezza	39,2 ⚡ Hauteur Altezza
----------------------------------	----------------------------------	-------------------------------

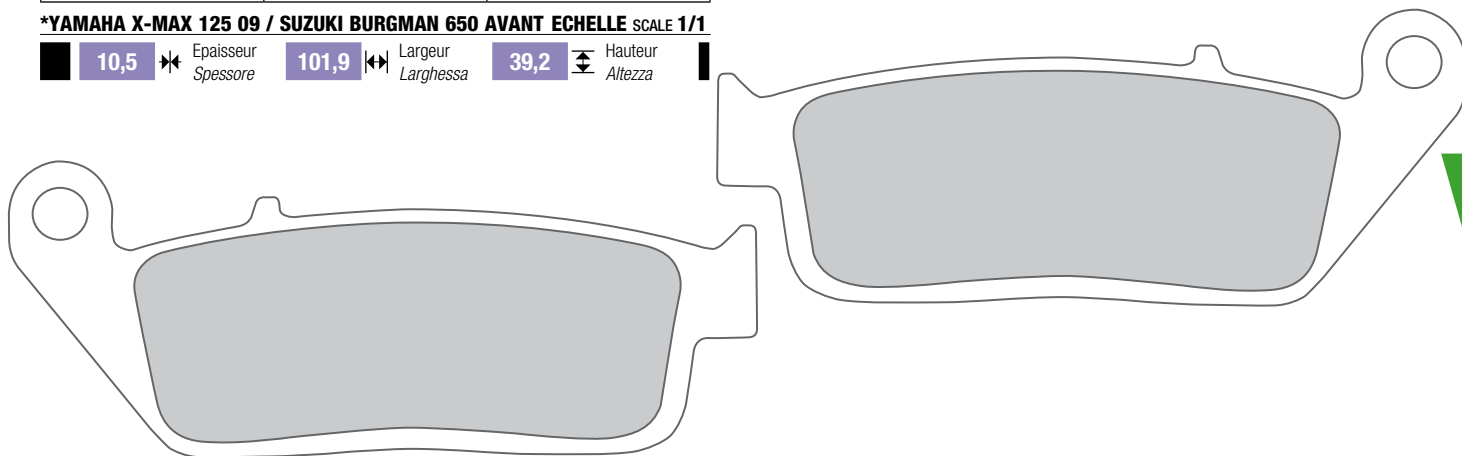

RD MAX 281930B		SKY SARHANY 281010
------------------------------------	--	--

* YAMAHA 500 T-MAX AV 2001 à 2003 ECHELLE SCALE 1/1

10 ✱ Epaisseur Spessore	102,1 ⇄ Largeur Larghezza	40,9 ⚡ Hauteur Altezza
--------------------------------	----------------------------------	-------------------------------

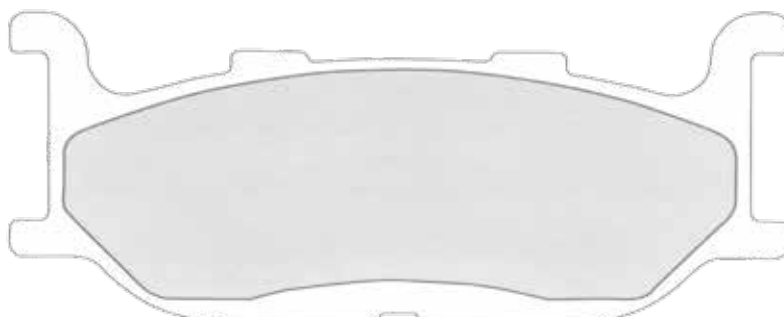

* Adaptable
* Adattabile

Les références du constructeur sont seulement indicatives et n'impliquent pas que les pièces de rechange viennent du constructeur.
I codici di riferimento originali sono indicativi e non implicano che i ricambi provengano necessariamente dalla stessa fabbrica del costruttore.

FREINAGE FRENI PLAQUETTES DE FREIN PASTIGLIE FRENO

TNT Original 281930L		SKY SARHANY 281010B
--	--	---

* YAMAHA 500 T-MAX ARRIERE POSTERIORE 2004 ECHELLE SCALE 1/1

11,8 ✱ Epaisseur Spessore	100 ⇄ Largeur Larghezza	38,5 ⚡ Hauteur Altezza
----------------------------------	--------------------------------	-------------------------------



RB MAX 281931A		
------------------------------------	--	--

* HONDA SH 300/SILVER WING 125/150 ARR. POST. ECHELLE SCALE 1/1

8,8 ✱ Epaisseur Spessore	81,7 ⇄ Largeur Larghezza	37,7 ⚡ Hauteur Altezza
---------------------------------	---------------------------------	-------------------------------



RB MAX 281930K		SKY SARHANY 281010A
------------------------------------	--	---

* YAMAHA 500 T-MAX AVANT ANTERIORE 2004 ECHELLE SCALE 1/1

10 ✱ Epaisseur Spessore	94 ⇄ Largeur Larghezza	40,7 ⚡ Hauteur Altezza
--------------------------------	-------------------------------	-------------------------------

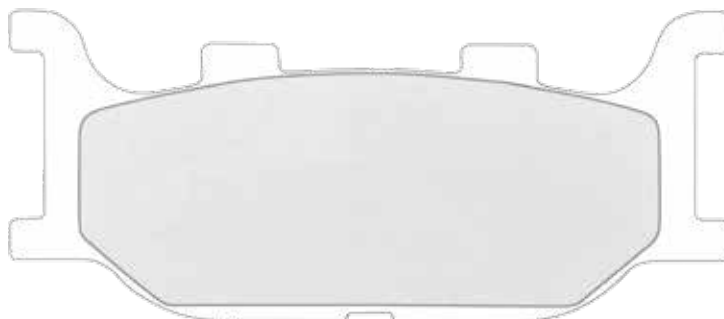

TNT Original 281930C		SKY SARHANY 281011
--	--	--

* HONDA SH125 AVANT ANTERIORE ECHELLE SCALE 1/1

8,5 ✱ Epaisseur Spessore	81,1 ⇄ Largeur Larghezza	42 ⚡ Hauteur Altezza
---------------------------------	---------------------------------	-----------------------------

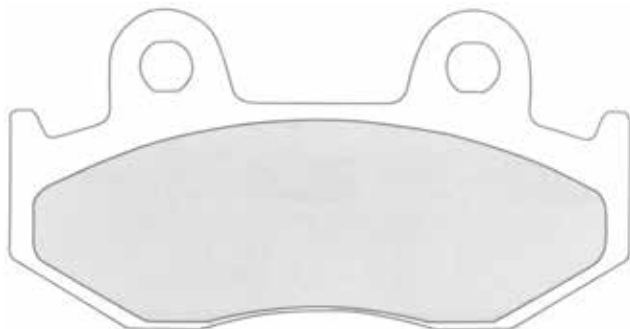

TNT Original 281930D		SKY SARHANY 281012
--	--	--

* HONDA DYLAN 125 AVANT ANTERIORE ECHELLE SCALE 1/1

9,3 ✱ Epaisseur Spessore	81,1 ⇄ Largeur Larghezza	42 ⚡ Hauteur Altezza
---------------------------------	---------------------------------	-----------------------------

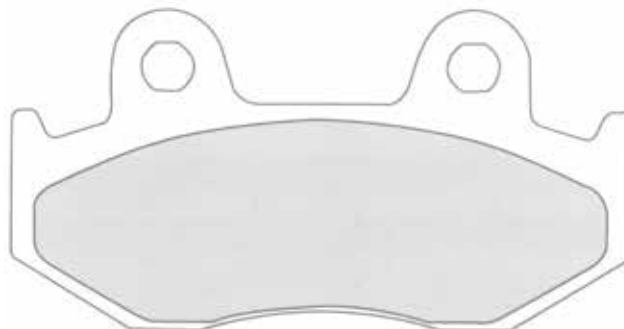

FREINAGE FRENI PLAQUETTES DE FREIN PASTIGLIE FRENO

TNT Original 281931		
---	--	--

***HONDA SH 300 / SILVER WING 125/150 AVANT ANT. ECHELLE SCALE 1/1**

A	9	Epaisseur Spessore	117,9	Largueur Larghessa	45,4	Hauteur Altezza
B	9	Epaisseur Spessore	117,9	Largueur Larghessa	45,4	Hauteur Altezza

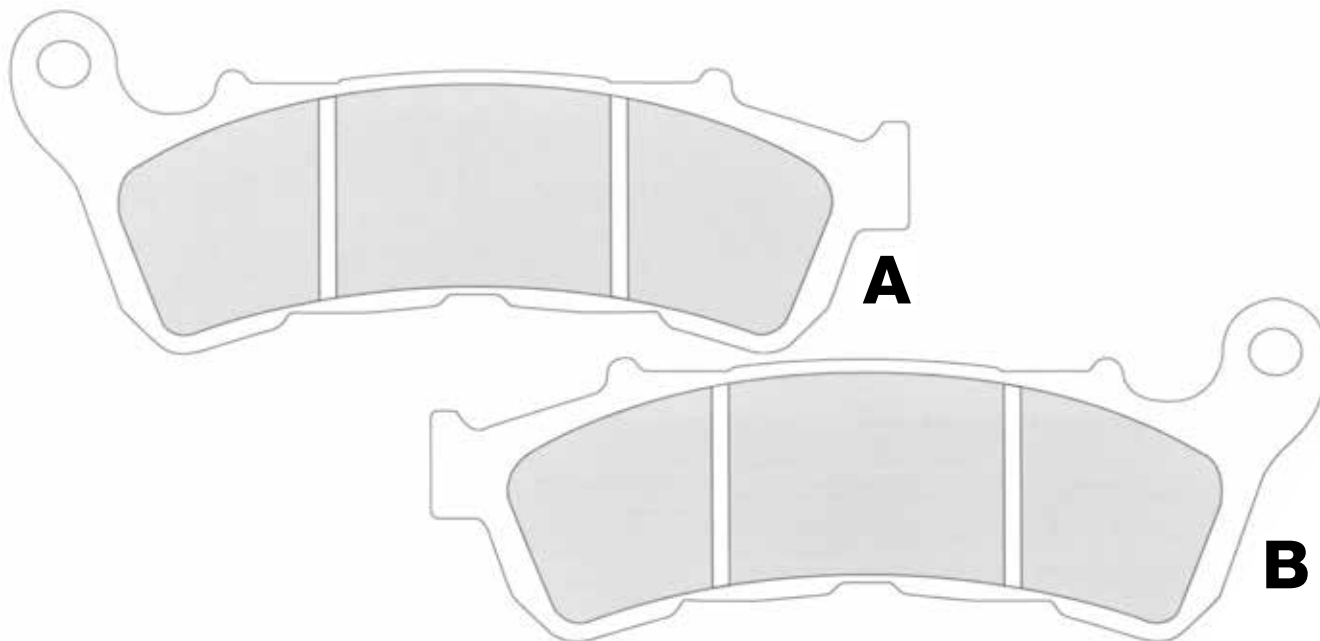

TNT Original 281930J		
--	--	--

***SUZUKI BURGMAN 400-250 AVANT ANTERIORE ECHELLE SCALE 1/1**

8,7	Epaisseur Spessore	44,8	Largueur Larghessa	53,6	Hauteur Altezza
------------	-----------------------	-------------	-----------------------	-------------	--------------------

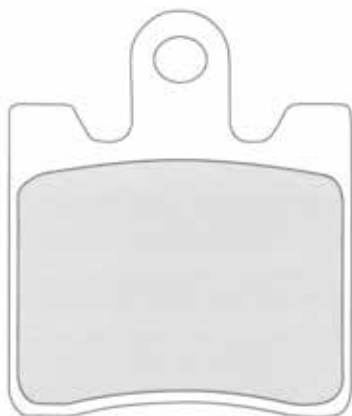

TNT Original 281930F		SKY SARKANY 281014
--	--	--

***SUZUKI INTRUDER AVANT ANTERIORE ECHELLE SCALE 1/1**

7,1	Epaisseur Spessore	76,8	Largueur Larghessa	53,8	Hauteur Altezza
------------	-----------------------	-------------	-----------------------	-------------	--------------------

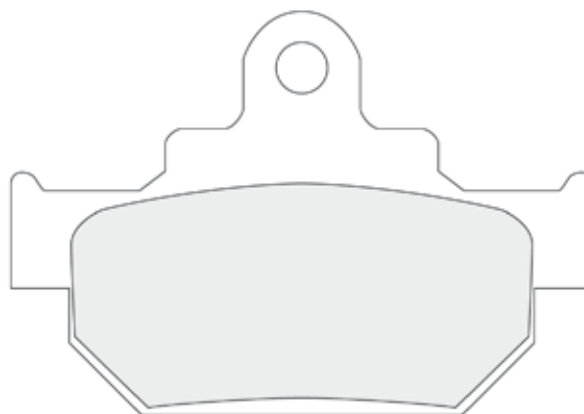

* Adaptable
* Adattabile

Les références du constructeur sont seulement indicatives et n'impliquent pas que les pièces de rechange viennent du constructeur.
I codici di riferimento originali sono indicativi e non implicano che i ricambi provengano necessariamente dalla stessa fabbrica del costruttore.

FREINAGE FRENI

PLAQUETTES DE FREIN PASTIGLIE FRENO

TNT Original 281922		
---	--	--

***DERBI SENDA DRD AVANT ANTERIORE** **ECHELLE SCALE 1/1**

7,5 ✱	Epaisseur Spessore	77 ✱✱	Largeur Larghezza	42 ✱	Hauteur Altezza
--------------	-----------------------	--------------	----------------------	-------------	--------------------

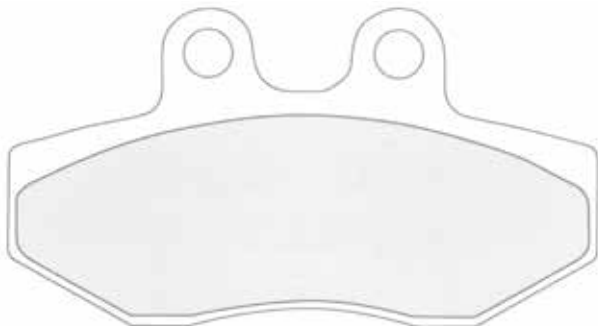

TNT Original 281914		
---	--	--

***RIEJU 50 MRT -RS2** **ECHELLE SCALE 1/1**

A 8 ✱	Epaisseur Spessore	85 ✱✱	Largeur Larghezza	42,5 ✱	Hauteur Altezza
B 10 ✱	Epaisseur Spessore	56 ✱✱	Largeur Larghezza	37,1 ✱	Hauteur Altezza

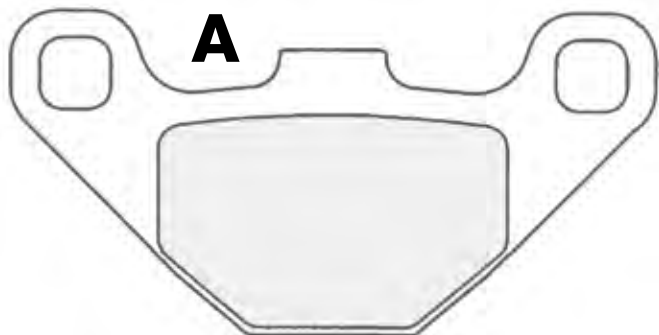

FREINAGE FRENI PLAQUETTES DE FREIN PASTIGLIE FRENO

Cyl. Cil.	Modèle Modello	Année Anno	TNT / RÖ Original		SKY SARKANY	
			Avant Ant.	Arrière Post.	Avant Ant.	Arrière Post.

ACCOSSATO						
50	CE	87-	281913	281913	281002	281002
50	Enduro	89-	281913	281921	281002	281007
80	KR	87-	281913	281921	281002	281007

ADLY						
50	Cat	06-	281949		281019	
50	Jet	06-	281949		281019	
50	Moto Fox Plus	02-	281948		281018	
50	Moto Silver Fox	02-	281948		281018	
50	Noble	05-	281948		281018	
50	Panther	02-	281948		281018	
50	Pista	05-	281949		281019	
50	Road racer	04-	281949		281019	
50	RS Supersonic	06-	281948	281948	281018	281018
50	Silver Fox	06-	281948		281018	
50	Thunder Bike	06-	281948		281018	
70	Pista	05-	281949		281019	
90	Road Racer	04-	281949		281019	
100	Cat	06-	281949		281019	
100	Jet	06-	281949		281019	
100	Noble	05-	281948		281018	
100	Panther	02-	281948		281018	
100	RT Road Racer	04	281949		281019	
100	Silver Fox	06-	281948		281018	
100	Thunder Bike	06-	281948		281018	
125	Cat	06-	281949		281019	
125	Noble	05-	281948		281018	
125	Super Sonic B	03-	281948	281948	281018	281018
125	Thunder Bike	06-	281948	281948	281018	281018

ADLY ATV						
150	Crusader Quad	06-	281948	281948	281018	281018
150	Interceptor	06-	281948	281948	281018	281018
300	Crusader Quad	06-	281948	281948	281018	281018
300	Interceptor	06-		281948		281018

AEON						
50	Aero	06-	281948		281018	
50	Nox	06-	281948		281018	
50	Regal	06-	281948		281018	
100	Aero	06-	281948		281018	
100	Nox	06-	281948		281018	
100	Pulsar	06-	281948		281018	
100	Revo R	03-		281948		281018
125	Nox	06-	281948		281018	
125	Pulsar	06-	281948		281018	
150	Nox	06-	281948		281018	
150	Pulsar	06-	281948		281018	
220	Cobra	06-	281948	281948	281018	281018
300	Overland 3,0	06-	281948	281948	281018	281018

AEON ATV						
50	Revo R	03-		281948		281018

ALFER						
80	MC	87-	281913	281911	281002	281000A
125	MC	87-	281913		281002	
125	MC	88-		281913		281002
125	VRE	00-	281917		281004	
250	AR	93-	281917		281004	
250	GR Enduro	85-	281913		281002	
250	GR Enduro	88-		281913		281002
250	MC	85-	281913		281002	
250	MC	87-	281913	281913	281002	281002
250	MC	88-		281913		281002
250	No Limits	95-	281917		281004	
250	Super Motard	01-	281917		281004	
250	VR	94	281917		281004	
250	VR All Models	99-	281917		281004	
250	VR Enduro	95-	281917		281004	
250	VR Motocross	95-	281917		281004	
300	GR	85-	281913		281002	
300	GR Enduro	88-		281913		281002
300	GR Enduro	85-87	281913		281002	
300	TX	90-	281911	281913	281000A	281002

ALPIA						
125	Renania Veronia	06-	281930K	281917A	281010A	

Cyl. Cil.	Modèle Modello	Année Anno	TNT / RÖ Original		SKY SARKANY	
			Avant Ant.	Arrière Post.	Avant Ant.	Arrière Post.

APRILIA						
50	AF1	90-	281921	281915	281007	
50	AF1	85		281915		
50	AF1 AE	86-89	281921	281915	281007	
50	AF-1 Europa / Futura	90-	281921		281007	
50	Amico all models	92-95	281910		281000	
50	Area 51	98-	281910	281910	281000	281000
50	Business	97-	281910		281000	
50	Classic	92-99	281921		281007	
50	Club	97-	281910		281000	
50	Compay	02-	281910		281000	
50	ET	85-86	281913		281002	
50	ET AE	87-	281921	281915	281007	
50	Europa	90-		281915		
50	Futura	90-		281915		
50	Gulliver LC	95-98	281910		281000	
50	Habana	98-01	281910		281000	
50	Mc Gulliver	00-	281910		281000	
50	Mojito	02-	281910		281000	
50	mojito Custom/Retro	99-03	281910		281000	
50	MX Supermotard	02-		281915		
50	Netscaper	97-	281910		281000	
50	Pegaso	94-	281921		281007	
50	Racing	98-	281910	281910	281000	281000
50	Rally	95-03	281910		281000	
50	Rally LC	96-99	281910	281910	281000	281000
50	Red rose	89-91	281921		281007	
50	Red Rose	92-	281921		281007	
50	RS	06-07	281920	281911	281006	281000A
50	RS	93-95	281913		281002	
50	RS	96-99		281913		281002
50	RS / Replica	00-		281915		
50	RS / RS Replica	99-05	281947			
50	RS Europa	94-	281910		281000	
50	RS Extrema	94-95	281910	281915	281000	
50	RS Replica	99-05		281915		
50	RS Rossi Replica	98-	281910	281915	281000	
50	RS Tuono	03-		281913		281002
50	RS Tuono	03-05	281947	281915		
50	RX	89-90		281915		
50	RX	91-94	281922	281915	281008	
50	Rx	95-03	281947	281915		
50	RX Racing	03--06	281947	281915		
50	Scarabeo	96-98	281910		281000	
50	Scarabeo 4T	04-	281930		281009	
50	Scarabeo de luxe	98-01	281910	281910	281000	281000
50	Scarabeo Ditech	02-	281910	281930N	281000	
50	Scarabeo street	00-	281910		281000	
50	Sonic	98-07	281910		281000	
50	Sport City	08-	281930A		281009A	
50	SR / SR Liquid	93-	281910		281000	
50	SR Catalized	00-		281930N		
50	SR Ditech	00-	281910	281930N	281000	
50	SR Ditech/Racing	00-	281910		281000	
50	SR Factory	05-		281930N		
50	SR Racing	00-		281930N		
50	SR Stealth	97-99	281910	281910	281000	281000
50	SR Street	05-	281910	281930N	281000	
50	SR Urban kid	94-	281910		281000	
50	SR Viper	92-	281910		281000	
50	SR www	97-01	281910		281000	
50	Tuareg	85	281913		281002	
50	Tuareg	86-	281921	281915	281007	
50	Tuareg	87-89	281921		281007	
50	Tuareg HPC System	87-89	281930A	281913	281009A	281002
50	Tuareg Rally	90-	281921	281915	281007	
50	Tuono	03-05	281947	281915		
70	Scarabeo	94-	281910		281000	
80	Classic	93-	281921		281007	
100	Scarabeo 4T	03-	281930		281009	
125	AF1	87-		281913		281002
125	AF1	85-86	281915	281915		
125	AF1 Europa/Futura	90-91		281913		281002
125	AF1 Replica/Sintesi	89-91		281913		281002
125	Arrecife	03-05	281930N			
125	Arrecife Sprint	06-	281930N			
125	ASR	86-		281913		281002
125	Atlantic	03-05	281930N			
125	Atlantic Sprint	06-	281930N			
125	Classic	96-	281930A	281913	281009A	281002

* Adaptable
* Adattabile

Les références du constructeur sont seulement indicatives et n'impliquent pas que les pièces de rechange viennent du constructeur.
I codici di riferimento originali sono indicativi e non implicano che i ricambi provengano necessariamente dalla stessa fabbrica del costruttore.

FREINAGE FRENI PLAQUETTES DE FREIN PASTIGLIE FRENO

Cyl. Cil.	Modèle Modello	Année Anno	TNT / RD Original		SKY SARHANY	
			Avant Ant.	Arrière Post.	Avant Ant.	Arrière Post.
125	Compay	03-	281910		281000	
125	ETX	85	281913		281002	
125	ETX	87-		281913		281002
125	ETX	86-	281930A		281009A	
125	ETX	99-	281947			
125	ETX Tuareg	86-87	281930A	281913	281009A	281002
125	Habana	00-02	281930		281009	
125	Leonardo	96-	281910	281915	281000	
125	Leonardo	97-98	281910	281910	281000	281000
125	Léonardo	99-	281930	281930	281009	281009
125	Léonardo (grimeca)	99-	281930A	281930	281009A	281009
125	Mojito	03-04	281930		281009	
125	Mojito Custom	00-02	281930		281009	
125	Mojito Retro	99-01	281930		281009	
125	MX (SM3)	04-	281917		281004	
125	MX Cross	85-	281930A		281009A	
125	Pegaso	91-92	281922		281008	
125	Pegaso Red Rose	88-89	281915			
125	RC	89-		281918		281005
125	Red Rose	89-	281930A	281913	281009A	281002
125	Red Rose	88-89	281921		281007	
125	Red Rose	91-	281922		281008	
125	RS	95-		281913		281002
125	RS Extrema/Replica	93-95		281913		281002
125	RS R Pista	04-		281913		281002
125	RX	85-	281913		281002	
125	RX	97-	281917		281004	
125	RX	92-	281922		281008	
125	RX	95-	281947			
125	RX CD	93-94	281947			
125	Scarabeo	98	281922		281008	
125	Scarabéo	98-04	281930N			
125	Scarabéo	05-	281930N			
125	Scarabéo/ Scarabéo GT	99-	281930A		281009A	
125	Sintesi	89-91		281913		281002
125	Sport City	04-	281930N			
125	Sport Prot.	92		281913		281002
125	Sportcity	05-	281930A		281009A	
125	SR	99-	281930		281009	
125	Tuareg	87-		281913		281002
125	Tuareg	-86	281930A		281009A	
125	Tuareg Rally	89-91		281913		281002
125	Tuareg Rally	91-01	281922		281008	
125	Tuareg Rally	86-89	281930A		281009A	
125	Tuareg wind	89-		281913		281002
125	Tuareg Wind	88-	281921	281915	281007	
125	Tuono	04-		281913		281002
125	TX M	85-	281911		281000A	
150	Leonardo	96-	281910	281915	281000	
150	Leonardo	97-98	281910	281910	281000	281000
150	Léonardo	99-	281930	281930	281009	281009
150	Léonardo (grimeca)	99-	281930A	281930	281009A	281009
150	Mojito	03-04	281930		281009	
150	Mojito Retro	99-01	281930		281009	
150	Scarabéo	99-	281930A		281009A	
150	Scarabéo	98-04	281930N			
150	SR	00-	281930		281009	
200	Arrecife	03-	281930N			
200	Atlantic	03-	281930N			
200	Climber	93-	281910	281910	281000	281000
200	Scarabéo	02-06	281930N			
200	Scarabéo	07-	281930N			
200	Scarabéo GT	02-06	281930N			
200	Scarabéo/ Scarabéo GT	02-	281930A		281009A	
200	Sport City	04-	281930N			
200	Sportcity	05-	281930A		281009A	
240	Climber	89-90	281921		281007	
240	Pegaso TR	85	281911		281000A	
240	TX	86-	281911		281000A	
250	Arrecife Sprint	06-	281930N			
250	Climber	89	281911	281911	281000A	281000A
250	Climber	90-91	281911	281915	281000A	
250	Climber R	92-	281911	281915	281000A	
250	Léonardo	99-	281930		281009	
250	Léonardo (grimeca)	99-	281930A		281009A	
250	MX Cross	85	281913		281002	
250	Replica	92-		281911		281000A
250	RS	98-		281910		281000
250	RS	95-97		281913		281002
250	RS Pista	04-		281913		281002

Cyl. Cil.	Modèle Modello	Année Anno	TNT / RD Original		SKY SARHANY	
			Avant Ant.	Arrière Post.	Avant Ant.	Arrière Post.
250	RS R Piste	04-		281910		281000
250	RX	86-	281913			281002
250	Scarabéo	05-	281930N			
250	Sport City	06-	281930N			
250	Tuareg Rally	85-		281913		281002
250	Tuareg Rally	86-	281930A		281009A	
275	Climber	89-90	281921	281915	281007	
280	Climber R	93-	281911	281911	281000A	281000A
280	R Climber	92-93		281915		
300	Léonardo	04-	281930N			
300	Léonardo (grimeca)	05-	281930A		281009A	
300	Pegaso TR	85	281911		281000A	
300	Sport City Cube	08-	281930N			
300	Tx	86-87	281911		281000A	
311	Tx	86-87	281911		281000A	
311	Tx	88	281911		281000A	
312	Tx	88	281911		281000A	
350	ETX	86-	281930A	281913	281009A	281002
350	ETX AE	87-		281913		281002
350	Tuareg	86-89		281913		281002
350	Tuareg	86-	281930A		281009A	
350	Tuareg Wind	87-88		281913		281002
350	Tuareg Wind	87	281930A		281009A	
400	Arrecife Sprint	07-	281930N			
400	Atlantic Sprint	07-	281930N			
400	Scarabéo ie	07-	281930N			
500	Arrecife	02-	281930N			
500	Arrecife Sprint	05-	281930N			
500	Atlantic	01-04	281930N			
500	Atlantic (left)	02-	281930A		281009A	
500	Atlantic (right)	02-	281930E		281013	
500	Atlantic Sprint	05-06	281930N			
500	Scarabéo	03-	281930N			
500	Scarabéo (left)	03-	281930A		281009A	
500	Scarabéo (right)	03-	281930E		281013	
500	Scarabéo ABS	03-	281930N			
600	ETX	86-	281930A	281913	281009A	281002
600	Pegaso	91-	281922		281008	
600	Tuareg	86-87	281930A	281913	281009A	281002
600	Tuareg Wind	88-		281913		281002
650	MOTO 6,5	95	281917		281004	
650	Pegaso	94-97	281947	281910		281000
650	Pegaso Strada	05-		281920		281006
1000	Blue Marlin	02-		281920		281006
1000	ETV Caponord	01-		281920		281006
1000	ETV Caponord Rally Raid	04-		281920		281006
1000	ETV Mana	02-		281917		281004
1000	RST Futura	01-		281917		281004
1000	RSV	97-01		281920		281006
1000	RSV Fact Replic	04-		281920		281006
1000	RSV Nero	04-		281920		281006
1000	RSV R	00-		281920		281006
1000	RSV R Fact Replic	04-		281920		281006
1000	RSV SP	00-		281920		281006
1000	RSV Tuono	02-		281920		281006
1000	RSV Tuono Fighter	03-		281920		281006
1000	RSV Tuono R	02-		281920		281006
1000	RSV Tuono Rac Fact	04-		281920		281006
1000	SL Falco	00-		281920		281006

ARMSTRONG						
500	MX	86-	281913		281002	
600	MX	86-	281913		281002	

ATALA						
25	Carosello	97-	281910		281000	
50	Byte AT10	97-	281910		281000	
50	Carosello	97-	281910		281000	
50	Hacker	95-	281910		281000	
50	Hacker Lc	99-	281910		281000	
50	Skeggia	98-	281910		281000	
125	Hacker	98-	281910		281000	

ATK						
250	CC/MX	91-92		281913		281002
350	ES/CC/MX/STD	91-92		281913		281002
350	GS	93-	281913	281913	281002	281002
406	CC/MX	91-92		281913		281002
560	ATK	84-88	281913		281002	
560	ATK	89-91		281921		281007

FREINAGE FRENI PLAQUETTES DE FREIN PASTIGLIE FRENO

Cyl. Cil.	Modèle Modello	Année Anno	TNT / RD Original		SKY SARKANY	
			Avant Ant.	Arrière Post.	Avant Ant.	Arrière Post.
560	ATK	87-88		281911		281000A
604	ATK	91-		281921		281007
604	ATK Quadracer	90-		281921		281007
604	ES/CC/MX/STD	91-92		281913		281002
620	2T Intimidator	04-	281917		281004	
640	ATK	93-	281913	281913	281002	281002
700	2T Intimidator	04-	281917		281004	

BENELLI						
Cyl. Cil.	Modèle Modello	Année Anno	Avant Ant.	Arrière Post.	Avant Ant.	Arrière Post.
50	491	98-	281910		281000	
50	491 Racing	98-	281910	281916	281000	
50	491 RR/ Superbike	01-	281910	281910	281000	281000
50	491 Sport	98-99	281910		281000	
50	491 ST	99-01	281910		281000	
50	491 Superbike	98-		281916		
50	491 X	07-	281910		281000	
50	Bunny	95-	281918		281005	
50	Chrono	92-93	281921		281007	
50	Chrono	94-	281910		281000	
50	K2 Air/LC/Namur	98-	281910	281910	281000	281000
50	K2 Racing	98-	281910	281910	281000	281000
50	K2 RR	01-	281910	281910	281000	281000
50	K2 SP	01-	281910	281910	281000	281000
50	K2 Superbike	98-	281910	281910	281000	281000
50	KB-X Race		281949		281019	
50	Naked	98-	281910		281000	
50	Nemo/Quadra	94-	281910		281000	
50	Pepe	99-01	281910		281000	
50	Pepe LX	03-04	281910		281000	
50	Quarantanove X	07-	281930G		281015	
50	ST	99	281911	281911	281000A	281000A
100	K2	00-	281910		281000	
100	LX Pepe	02-	281910		281000	
100	Naked	02-	281910		281000	
124	T	83-	281913		281002	
125	2CE	76-78	281913		281002	
125	666	98-		281920		281006
125	Adiva	01-	281947			
125	BKX	88-	281913	281911	281002	281000A
125	BX	88-		281913		281002
125	Custom	85-	281913		281002	
125	E	86-	281913		281002	
125	ELC	85-	281913		281002	
125	Jarno	88-89		281913		281002
125	Macis	08-	281930H	281930H	281006B	281006B
125	Sport		281913		281002	
125	T	76-	281913		281002	
125	T2C	76-	281913		281002	
125	TT		281913		281002	
125	Velvet/Velvet Touring	99-	281910		281000	
150	Adiva	01-	281947			
150	Velvet/Velvet Touring	00-	281910		281000	
250	Cafe Nero SX	-08	281919			
250	2CE		281913		281002	
250	Disc	76-	281913		281002	
250	Quattro , TS	76-	281913		281002	
250	Velvet/Velvet Touring	99-	281910		281000	
250	Velvet	99-	281930N			
250	Velvet Touring	99-	281930N			
304		83-	281913		281002	
350	4T Turismo	78-	281913		281002	
350	RS	82-	281913		281002	
354		78-82	281913		281002	
354	Sport	83-	281913	281913	281002	281002
400	Velvet Dusk	03-	281930N	281910		281000
400	Velvet dusk	03-	281947			
449	BX	07-	281917		281004	
510	Enduro	08-	281917		281004	
654	Sport	83	281913	281913	281002	281002
750	Due	07-	281920		281006	
900	TNT 899 S/T	08-		281920		281006
900	Tornado TRE	00-02		281913		281002
900	Tornado TRE	03-		281920		281006
900	Tornado Tre LM	03-		281920		281006
900	Tornado Tre RS	04-		281920		281006
1100	TNT	04-		281913		281002
1130	Sport Tornado Naked TRE	06-		281920		281006
1130	TNT	04-		281920		281006
1130	TNT Café Racer	05-		281920		281006
1130	TNT Sport	05-		281920		281006

Cyl. Cil.	Modèle Modello	Année Anno	TNT / RD Original		SKY SARKANY	
			Avant Ant.	Arrière Post.	Avant Ant.	Arrière Post.
1130	TNT Titanium	05-		281920		281006
1130	Tornado Tre	06-		281920		281006
1130	Trek Amazonas	07-		281920		281006

BETA						
Cyl. Cil.	Modèle Modello	Année Anno	Avant Ant.	Arrière Post.	Avant Ant.	Arrière Post.
50	Alp	89-93	281911		281000A	
50	Alp	94-	281911		281000A	
50	APL RK6	96-	281930A		281009A	
50	Ark Aria	96-05	281910		281000	
50	Ark LC	96-03	281910		281000	
50	Ark LC -R	97-	281910	281910	281000	281000
50	Ark LC Série K	98-	281910	281910	281000	281000
50	AR-T	03-04	281947	281911		281000A
50	AR-T	05-	281947			
50	Chrono 13	94-	281910		281000	
50	Chrono 502	97-	281913		281002	
50	Eikon	04-	281910	281930N	281000	
50	Eikon	99-03	281911	281911	281000A	281000A
50	KR	86-		281915		
50	KR	87-88	281921	281915	281007	
50	KR	89-	281911	281915	281000A	
50	KR Adventure	87-	281921		281007	
50	MX	92-	281921	281921	281007	281007
50	MX Enduro	92-	281911	281911	281000A	281000A
50	Quadra	95-99	281910		281000	
50	Quadra	97-	281913		281002	
50	REV 3	00-	281911	281911	281000A	281000A
50	RK 6	94-98		281911		281000A
50	RK 6	96-	281910	281910	281000	281000
50	RK 6T	99-01	281911	281911	281000A	281000A
50	RK 6T supermotard	99-01	281911	281911	281000A	281000A
50	RR	98-	281930A		281009A	
50	RR Enduro	99-		281911		281000A
50	RR Enduro	08-	281947			
50	RR Enduro / Standard	99-	281922		281008	
50	RR Enduro Alu	04-		281911		281000A
50	RR Enduro Alu / Motard Alu	04-	281922		281008	
50	RR Motard	04-	281922	281911	281008	281000A
50	RR Motard	08-	281947			
50	RR Motard Alu	04-		281911		281000A
50	RR Pro race	98-	281922	281911	281008	281000A
50	RR Standard	99-		281911		281000A
50	RR Supermotard	99-03	281922	281911	281008	281000A
50	RR T	99-01		281911		281000A
50	RR T	02-05	281911	281911	281000A	281000A
50	SR 34	89-	281911		281000A	
50	ST	94-96	281911		281000A	
50	ST	97-	281911	281911	281000A	281000A
50	super trial	92-	281911		281000A	
50	Techno	96-	281911	281911	281000A	281000A
50	Tempo	99-	281910		281000	
50	Tempo	92-96	281911		281000A	
50	Tempo	97-98	281913		281002	
50	TR 35	89-	281911		281000A	
50	TR Campionato	89-	281911		281000A	
50	Zero	94-	281911		281000A	
80	Rev	02-	281911	281911	281000A	281000A
80	REV 3	00-07	281911	281911	281000A	281000A
125	00 ALP 4 stroke	00-	281911	281911	281000A	281000A
125	00 Eurotek/Techno	96-98	281911	281911	281000A	281000A
125	ALP	97-	281911	281911	281000A	281000A
125	ALP	06-07	281947			
125	ALP	08-	281947			
125	Eikon	04-	281910		281000	
125	Eikon	99-03	281911	281911	281000A	281000A
125	KR	86	281913		281002	
125	KR Africa	87-	281913		281002	
125	KR Techno	94	281911		281000A	
125	RR 4T	06-	281947			
125	RR 4T SM	06-	281947			
125	RR Enduro	08-	281947			
125	RR Motard	08-	281947			
125	SYNT	94-	281911		281000A	
125	TR 34	88-		281921		281007
125	TR 34 R Campionato	89-90	281911		281000A	
125	TR 34/35	89-90	281911	281911	281000A	281000A
125	TR 35	91-	281911		281000A	
125	TRIAL	97-	281911		281000A	
125	Urban	08-	281947			
125	zero	92-	281911		281000A	

* Adaptable
* Adattabile

Les références du constructeur sont seulement indicatives et n'impliquent pas que les pièces de rechange viennent du constructeur.
I codici di riferimento originali sono indicativi e non implicano che i ricambi provengano necessariamente dalla stessa fabbrica del costruttore.

FREINAGE FRENI PLAQUETTES DE FREIN PASTIGLIE FRENO

Cyl. Cil.	Modèle Modello	Année Anno	TNT / RD Original		SKY SARKANY	
			Avant Ant.	Arrière Post.	Avant Ant.	Arrière Post.
150	Eikon	04-	281910		281000	
150	Eikon	99-03	281911	281911	281000A	281000A
200	ALP	08-	281947			
200	ALP	00-07	281911	281911	281000A	281000A
200	Urban	08-	281947			
240	ALP	97-	281913			281002
240	ALP	92-96	281911		281000A	
240	ALP	89-91	281911		281000A	
240	ST	92-	281911		281000A	
240	Super Trial	92-	281911		281000A	
240	TR 35 Reverse	89-91	281911		281000A	
250	África	86-	281913		281002	
250	ALP	92-96	281911		281000A	
250	ALP	97-	281911	281911	281000A	281000A
250	ALP Techno	94-02	281911		281000A	
250	ALP Zero	91-	281911		281000A	
250	CR	83-	281913		281002	
250	Eikon	99-	281910	281910	281000	281000
250	KR	86	281913		281002	
250	KR Rally	87-	281913		281002	
260	ALP	96-	281911	281913	281000A	281002
260	ALP Zero	91-	281911		281000A	
260	SYNT	92-93	281911		281000A	
260	TR 34	86-87		281921		281007
260	TR 34	88-		281921		281007
260	TR 34 R Super trial	89-92	281911	281911	281000A	281000A
260	TR Zero/34/35	89-92	281911		281000A	
350	4,0 Motard	04-		281915		
350	ALP 4,0	03-07	281947			
350	ALP 4,0	04-	281947			
350	ALP 4,0	08-	281947			

BIMOTA						
400	YB7	89-		281913		281002
500	TESI 2 V Due	97-		281913		281002
500	V-Due	98-		281913		281002
500	V-due evoluzione	00-		281913		281002
600	Bellaria	91-		281913		281002
600	YB9	96-		281913		281002
600	YB9 Super Sport	93-		281913		281002
650	BB1 Supermono	96-		281913		281002
750	DB 1 RS	87-		281913		281002
750	SB 6	94-		281913		281002
750	SB7	96		281913		281002
750	YB4	87-		281913		281002
851	1D Tesi	90-95		281913		281002
900	DB2	92-		281913		281002
900	DB4	99-		281913		281002
900	Mantra	96-		281913		281002
904	1D Tesi SR/ES	96-		281913		281002
904	DB2 HF/SR	96-		281913		281002
906	1D Tesi	91-95		281913		281002
992	DB5 Mille	05-		281920		281006
992	Tesi 2D	06-		281913		281002
996	SB 8K Santamonica	06-		281913		281002
996	SB 8R Special	97-		281913		281002
1000	DB 5 Mille	05-		281920		281006
1000	Delirio	07-		281920		281006
1000	Dieci	91-		281913		281002
1000	Dieci Biposto	92-95		281913		281002
1000	SB 8 R	99-		281920		281006
1000	Tesi 2D	05-		281913		281002
1000	Tesi 3D	07-		281920		281006
1000	YB 10 Biposto	93-		281913		281002
1000	YB11	97-		281913		281002
1000	YB6	89		281913		281002
1000	YB8	90-95		281913		281002
1002	YB11 Dieci	91-95		281913		281002
1002	YB11 Superleggera	96		281913		281002
1100	DB7	08-		281920		281006
1100	SB 7	94-		281913		281002
1100	SB6	96-		281913		281002
1100	SB6 R	97-		281913		281002
1100	Tuatar	90-		281913		281002
1200	YB 5	87-		281913		281002

BLANEY ATV						
125	XC Trojan	03-		281930M		
200	XL Trooper	03-		281919		

Cyl. Cil.	Modèle Modello	Année Anno	TNT / RD Original		SKY SARKANY	
			Avant Ant.	Arrière Post.	Avant Ant.	Arrière Post.
BLATA						
125	Enduro	07-		281911		281000A
125	Motard	07-		281911		281000A

BMW						
450	G X	08-	281917		281004	
510	Enduro	08-	281917		281004	
850	R	95-		281917		281004
1100	RT ABS/RT/GS ABS/GS/R	95-		281917		281004
1100	S	98-		281917		281004
1150	GS/GS Adventure	02-		281917		281004
1150	R	01-		281917		281004
1150	RS/RT	02-		281917		281004
1200	C	98-		281917		281004
1200	CL	03-		281917		281004
1200	GS	04-		281917		281004
1200	RS	02-		281917		281004
1200	S/RT	05-		281917		281004

BOMBARDIER ATV						
200	Rally 2x4	03-05	281948		281018	
200	Rally 2x4	05-	281948		281018	
500	Traxter 4X4	99-01	281920	281920	281006	281006

BULTACO						
50	Astro	00-	281922	281911	281008	281000A
50	Lobito	99-	281922	281911	281008	281000A
125	sherco	00-	281911	281911	281000A	281000A
125	Streaker	75-	281913		281002	
200	sherco	00-	281911	281911	281000A	281000A
250	GTS	75-	281913		281002	
250	Sherco	99-	281911	281911	281000A	281000A
290	sherco	00-	281911	281911	281000A	281000A

CAGIVA						
50	Blues	89-	281930A		281009A	
50	City	95-	282052Z		281020	
50	Cocis	88-		281915		
50	Corsa	98-	281911		281000A	
50	Cucciolo	97-	281913		281002	
50	Cucciolo	01-	281910		281000	
50	K3	92-		281915		
50	Lucky Explorer	88-		281915		
50	Mantis	99-	281911		281000A	
50	Mito	98-		281911		281000A
50	Nuvola	00-	281910		281000	
50	Passing	95-	282052Z		281020	
50	Prima Strada	92-		281915		
50	Progress	98-	281910		281000	
50	W4 Pro Action	92-		281915		
80	Cocis	91-	281913		281002	
80	Cocis	89-		281915		
80	LR	83-	281913		281002	
80	Prima	92-	281930M	281921		281007
80	SST	83-	281913		281002	
80	Super City	92-93	281913	281913	281002	281002
80	Super City	94-		281913		281002
80	SXT	83-	281913		281002	
80	W4	92-	281913	281913	281002	281002
116	Stella	97-	281930M			
125	Aletta Electra	87-	281913		281002	
125	Aletta Electra	83-	281915			
125	Aletta Oro	86-	281913	281913	281002	281002
125	Aletta Oro S2	86-	281915	281915		
125	Blues	93-	281930A	281913	281009A	281002
125	Blues	93-	281913	281913	281002	281002
125	Cruiser	88-		281913		281002
125	Cruiser	87		281915		
125	Cucciolo	99-	281910		281000	
125	Dakar	86	281913		281002	
125	E2	86-	281915			
125	Electra	88-	281915			
125	Elefant	81-	281915			
125	Elefant	87-	281913		281002	
125	Enduro	86-	281913		281002	
125	Freccia	89	281913		281002	
125	Freccia C10	88		281913		281002
125	Freccia C10 anniversario	89-		281913		281002
125	Freccia C12R	91-		281913		281002
125	Freccia C9	87-		281913		281002

FREINAGE FRENI PLAQUETTES DE FREIN PASTIGLIE FRENO

Cyl. Cil.	Modèle Modello	Année Anno	TNT / RD Original		SKY SARKANY	
			Avant Ant.	Arrière Post.	Avant Ant.	Arrière Post.
125	K7	91-		281913		281002
125	Mito	93-		281913		281002
125	Mito Corsa	89-94		281913		281002
125	Mito Eddy	93-		281913		281002
125	Mito EV/SP	95-		281913		281002
125	Mito Racer	91-92		281913		281002
125	Mito SP 525	08-		281913		281002
125	N1	97-		281913		281002
125	Nuvola	00-	281910		281000	
125	Passing	95-	282052Z		281020	
125	Planet	97-		281913		281002
125	Raptor	03-		281913		281002
125	Roadster	93-	281930A		281009A	
125	SST	81-	281915			
125	Supercity	92-95		281913		281002
125	Supercity	98-98		281913		281002
125	Tamanaco	89		281913		281002
125	W8	92-	281913	281913	281002	281002
125	W8 /R	94-		281915		
125	W8 Pro Action	91-		281915		
125	WMX GP Replica	86-	281913		281002	
125	WRX		281913		281002	
125	WSTX Aletta Rossa	83-	281915			
200	Aletta Electra	83-	281915			
200	E2	86-	281915			
200	Elefant	86-	281913		281002	
200	Elefant	88-	281915			
200	Roadster	96-	281930A		281009A	
250	ALA Blue	83-	281913		281002	
250	MXR	82-	281913		281002	
250	SST Ala Verde	81-	281913		281002	
250	VRX	83-	281913		281002	
250	WMX GP	82-	281913		281002	
350	Ala Azzurra	84	281913	281913	281002	281002
350	Ala blu	83	281913		281002	
350	Elefant	86-		281913		281002
350	Elefant	83-	281930A		281009A	
350	SST	83-	281913		281002	
350	SST Ala Verde	81-	281913		281002	
350	SX	83-	281913		281002	
350	T4 E/R	87-	281913		281002	
400	MXR	82-	281913		281002	
500	Canyon	99-01		281919		
500	Enduro	86-	281913		281002	
500	Mito	07		281913		281002
500	Mito	08-		281913		281002
500	MXR	82-	281913		281002	
500	River	00-		281913		281002
500	T4 E	87-	281913		281002	
500	WMR GP	82-	281913		281002	
500	WMX	85-	281913		281002	
500	WMX Cross	87	281913	281913	281002	281002
600	Aletta Electra Touring	86-	281915			
600	Canyon	95-		281919		
600	River	94-98		281913		281002
650	Ala Azzurra Gt	87-	281930A	281913	281009A	281002
650	Ala azzurra		281913	281913	281002	281002
650	Elefant	86-		281913		281002
650	Paris Dakar	86-	281930A	281913	281009A	281002
650	Raptor/ V Raptor	01-	281920	281920	281006	
650	Touring	86-		281913		281002
750	Dakar	87-		281913		281002
750	E Elefant	94-95		281917		281004
750	E Elefant	96-	281917	281917	281004	281004
750	Elefant	88	281913	281913	281002	281002
750	Lucky Explorer	88		281913		281002
900	Canyon	97-		281919		
900	E Elefant	93-97	281917	281917	281004	281004
900	Elefant ie	91-92		281919		
900	Gran Canyon	99-		281919		
909	Canyon	98-	281919			
909	Gran Canyon	99-		281919		
1000	Navigator /T	00-		281919		
1000	Raptor Xtra	02-		281920		281006
1000	Raptor/ V Raptor	00-		281920		281006
1000	X Raptor	03-		281920		281006
1000	X3 Raptor	04-		281920		281006

CAN AM						
200	ASE	86-	281913		281002	

Cyl. Cil.	Modèle Modello	Année Anno	TNT / RD Original		SKY SARKANY	
			Avant Ant.	Arrière Post.	Avant Ant.	Arrière Post.
250	ASE	86-	281913		281002	
250	LC	86-	281913		281002	
250	MX	86-	281913		281002	
350	ASE	86-	281913		281002	
406	ASE	86-	281913		281002	
500	ASE	86-	281913		281002	
500	LC	86-	281913		281002	
500	MX	86-	281913		281002	
560	SONIC	86-	281913		281002	

CAN AM ATV						
200	Rally	07-	281930M			

CCM						
125	C-XR 125 E	08-	281930M			
125	C-XR 125 M	08-	281930M			
125	C-XR 125 S	08-	281930M			
125	SM	-08		281919		
125	TL	-08	281930M	281919		
230	C-XR 230 E	07-	281930M			
230	C-XR 230 S	07-	281930M			
230	C-XR 230M	07-	281930M			
404	DS	03-	281917		281004	
404	DS Super Motard	03-	281917		281004	
404	E	03-	281917		281004	
604	DS Supermoto (SM3)	99-01	281917		281004	
604	RS Roadster (SM3)	01	281917		281004	
644	DS Supermoto (SM3)	02-	281917		281004	
644	RC 30 (SM3)	02-	281917		281004	
710	FT	08-	281917		281004	

CH RACING						
50	WSM Motard	05-		281911		281000A
50	WXE	05-	281922		281008	
50	WXE Enduro	05-		281911		281000A
50	WXM	05-	281922		281008	
125	WSM	05-	281922		281008	
125	WSM Motard	05-		281911		281000A
125	WXE	05-	281922		281008	
125	WXE Enduro	05-		281911		281000A

CLIPIC						
50	CJ E	99-	281911	281911	281000A	281000A
50	CJ R	99-	281911	281911	281000A	281000A
80	CJ R	99-	281911	281911	281000A	281000A
125	MINJ	06-	281911	281911	281000A	281000A
200	MINJ	06-	281911	281911	281000A	281000A

CONTI						
50	Promo cup	00-03	281915	281910		281000
50	Promo cup	04-		281910		281000

CPI						
50	Aragon	06-	281930G		281015	
50	Freaky	07-	281930G		281015	
50	GP	06-	281930G		281015	
50	GTR/GTS	03-	281947	281910		281000
50	Hussar	03-	281930G		281015	
50	Hussar	01-	281948		281018	
50	Popcorn	01-	281930G		281015	
50	SM Power	06-	281911	281911	281000A	281000A
50	Super Cross	06-	281911	281911	281000A	281000A
50	Super Cross Ultimate	06-	281911	281911	281000A	281000A
50	SX Power	06-	281911	281911	281000A	281000A
125	Aragon	07-	281930G		281015	
125	GP	07-	281930G		281015	
125	GTR/GTS	03-	281947	281910		281000
125	Super Moto	07-	281911	281911	281000A	281000A
125	X-Large	03-	281920	281920	281006	281006
150	GTR/GTS	03-	281947	281910		281000
150	X-Large	03-	281920	281920	281006	281006
200	GTR/GTS	03-	281947	281910		281000
250	X-Large	03-	281920	281920	281006	281006

CPI ATV						
50	CRAB	03-		281948		281018
50	TOX	03-		281948		281018
100	CRAB	03-		281948		281018
100	TOX	03-		281948		281018

* Adaptable
* Adattabile

Les références du constructeur sont seulement indicatives et n'impliquent pas que les pièces de rechange viennent du constructeur.
I codici di riferimento originali sono indicativi e non implicano che i ricambi provengano necessariamente dalla stessa fabbrica del costruttore.

FREINAGE FRENI PLAQUETTES DE FREIN PASTIGLIE FRENO

Cyl. Cil.	Modèle Modello	Année Anno	TNT / RD Original		SKY SARKANY	
			Avant Ant.	Arrière Post.	Avant Ant.	Arrière Post.

CSR						
125	ONA	04-	281930G	281930G	281015	281015
125	SCOO	04-	281930G	281930G	281015	281015
150	ONA	06-	281930G	281930G	281015	281015
150	SCOO	06-	281930G	281930G	281015	281015

DAELIM						
110	CITI ACE	-06	281919			
125	B-Bone	08-	281930J		281016	
125	Delfino	08-	281919			
125	Otelo f,j	08-	281930J		281016	
125	Roadwin	04-		281919		
125	S2 Freewing f,i	08-	281930J		281016	
250	Roadwin	08-		281919		

DAELIM ATV						
250	ET	06-	281948	281919	281018	
300	ET Quad	07-	281948		281018	

DERBI						
50	Aceno	98-	281911		281000A	
50	Atlantis	99-	281911		281000A	
50	Atlantis 4T/Bullet	04-	281911		281000A	
50	Atlantis H2O/Wave	01-	281911		281000A	
50	Aventura	95-	281911		281000A	
50	Black Devil	04-	281947	281911		281000A
50	coppa FDT	85-	281911		281000A	
50	Coppa FDX	87-	281911		281000A	
50	DS	88	281911		281000A	
50	DS World Champion	88-	281911		281000A	
50	Easy	96-	281911		281000A	
50	FD Yumbo	85-	281911		281000A	
50	FDX	89-	281911		281000A	
50	Fenix	93	281911		281000A	
50	Fenix	94-	281911	281911	281000A	281000A
50	Furax	95-	281911	281911	281000A	281000A
50	Furax	96-	281911		281000A	
50	GP1	01-04	281911	281911	281000A	281000A
50	GP1	05-	281920	281911	281006	281000A
50	GP1 Open	06-	281947	281911	281000A	281000A
50	GPR Nude	04-	281920	281911	281006	281000A
50	GPR R	97-		281911		281000A
50	GPR R	04-	281920		281006	
50	GPR R	97-03	281922		281008	
50	GPR Racing	05-		281911		281000A
50	GPR Sport	93-96	281921	281915	281007	
50	GPX 1	06-	281920	281911	281006	281000A
50	Hunter	96-	281911		281000A	
50	Manhattan	99-	281911		281000A	
50	Paddock	96-	281911		281000A	
50	predator	98	281911	281911	281000A	281000A
50	predator 0,2	99-	281911		281000A	
50	Predator LC	98-	281911	281911	281000A	281000A
50	Progress	97-	281911		281000A	
50	R DRD	05-	281947	281911		281000A
50	R Racer/R X-Treme	05-	281911	281911	281000A	281000A
50	Racer	05-	281947			
50	Rambla	06-	281921A	281921A		
50	Record	98-	281911		281000A	
50	Sabana	90-	281911	281911	281000A	281000A
50	Savanah	91-	281911		281000A	
50	Senda DRD R Racing	06-	281947			
50	Senda DRD R Racing Pro	06-	281920	281911	281006	281000A
50	Senda DRD Racing	06	281920	281911	281006	281000A
50	Senda DRD SM Edition	06-	281920	281911	281006	281000A
50	Senda L	99-	281911	281911	281000A	281000A
50	Senda Pro	08-	281920		281006	
50	Senda R DRD	03-04	281922	281911	281008	281000A
50	Senda R DRD	05-	281947			
50	Senda R/X-Treme	94-04	281911	281911	281000A	281000A
50	Senda SM DRD	03-04	281911	281911	281000A	281000A
50	Senda SM DRD Black edit	03-	281947	281911		281000A
50	Senda SM/X-Treme	99-04	281911	281911	281000A	281000A
50	SM DRD	05-	281947	281911		281000A
50	SM Racer	05-		281911		281000A
50	SM X-Treme/X-Race	05-	281947	281911		281000A
50	Stinger	96-	281911		281000A	
50	Urban	94-	281911		281000A	
50	Vamos	94	281911		281000A	
50	Vamos R (Brembo cal)	95-	281910		281000	

Cyl. Cil.	Modèle Modello	Année Anno	TNT / RD Original		SKY SARKANY	
			Avant Ant.	Arrière Post.	Avant Ant.	Arrière Post.

50	Vamos R/L/FL	95-	281911		281000A	
50	Variant Sport R	01-	281911		281000A	
50	Wave	00-	281911		281000A	
50	X-Race	05-	281947			
75	GPR	89-	281921	281911	281007	281000A
75	GPR Sport	90-	281921	281915	281007	
75	Sport Coppa	84-	281911		281000A	
75	TT8	84-	281913		281002	
75	Yumbo RD-2, FDS	87-	281911		281000A	
100	Atlantis 4T	01-06	281911		281000A	
100	Atlantis HO/H2O	01-	281911		281000A	
125	Atmosphere	99-	281911		281000A	
125	Boulevard	03-06	281921A			
125	Boulevard S	07-	281930A		281009A	
125	Boulevard	04-	281911		281000A	
125	Freexter	06-		281921A		
125	GP1	06-	281920	281920	281006	281006
125	GPR nude	04-		281911		281000A
125	GPR R	04-		281911		281000A
125	Mulhacen	06-	281947	281921A		
125	Predator	99-	281911	281911	281000A	281000A
125	Rambla	06-	281921A	281921A		
125	Rambla	07-08	281930A		281009A	
125	Senda DRD R Racing	06-	281947	281911		281000A
125	Senda R 4T	04-	281947	281911		281000A
125	Senda SM 4T	04-	281947	281911		281000A
125	Terra 4T	06-	281921A	281921A		
125	Terra 4T Adventure	08-		281921A		
125	TT8	84-	281913		281002	
150	Boulevard	03-	281921A			
150	Boulevard	04-	281911		281000A	
200	Boulevard	05-	281921A			
250	GP1	05-	281920	281920	281006	281006
250	GP1	07-	281920		281006	
250	RC	85	281913		281002	
650	Mulhacen	06-		281920		281006

DUCATI						
350	F3	86-	281913		281002	
350	Indiana	86-		281913		281002
350	Paso	86-	281913		281002	
350	Sport	92-		281913		281002
350	Sport GTV	76-91	281913	281913	281002	281002
350	Twin GTL	75-	281913		281002	
400	Desmo F3	87-	281913		281002	
400	Monster	07-08	281917		281004	
400	Monster	02-08		281920		281006
400	SS Junior	91-92		281913		281002
400	SS Naked	92-		281913		281002
400	Supersport	93-		281913		281002
500	GTV	77-	281913		281002	
500	Pantah	85-		281913		281002
500	Pantah SL	78-	281913		281002	
500	Pantah TL	78-	281913		281002	
500	Sport Desmo	77-	281913		281002	
500	Sport GTV	76-91	281913	281913	281002	281002
500	Twin GTL	75-	281913		281002	
600	Monster	93-		281913		281002
600	Pantah SL	76-		281913		281002
600	Pantah TL	76-		281913		281002
600	SS	94-		281913		281002
600	SuperSport	94-01		281913		281002
620	Monster	05-06	281917	281913	281004	281002
620	Monster	02-06		281913		281002
620	Monster Dark	06-		281913		281002
620	Monster dark	05-	281917	281920	281004	281006
620	Monster IE/S	02-04		281913		281002
620	Multistrada	06-		281913		281002
620	Multistrada MTS	06-	281917	281920	281004	281006
620	Sport	03-		281920		281006
620	SS	03-		281920		281006
650	Desmo	87-		281913		281002
650	Indiana	86-		281913		281002
695	Monster	06-08	281917	281913	281004	281002
696	Monster	08-		281920		281006
748	Biposto/SP/S	95-98		281913		281002
748	E	00-02		281913		281002
748	S/R	99-00		281913		281002
748	SPS	98-		281913		281002
749	Dark	04-		281920		281006

FREINAGE FRENI PLAQUETTES DE FREIN PASTIGLIE FRENO

Cyl. Cil.	Modèle Modello	Année Anno	TNT / RB Original		SKY SARKANY	
			Avant Ant.	Arrière Post.	Avant Ant.	Arrière Post.
749	R	04-		281920		281006
749	S	03-		281920		281006
750	F1 Desmo	86-		281913		281002
750	Indiana	88-		281913		281002
750	Monster	96-		281913		281002
750	Paso	87-88		281913		281002
750	Sport SS	92-98		281913		281002
750	SS	98-02		281920		281006
750	Supersport	00-02		281920		281006
800	Monster S/Dark	03-		281913		281002
800	Monster S2R	05-		281913		281002
800	Monstezr S i.e	03-04		281920		281006
800	S2R	05-07	281917	281920	281004	281006
800	S2R Dark	05-06	281917	281920	281004	281006
800	Sport/Supersport	03-07		281920		281006
848		07-		281920		281006
851	Sport/Biposto/Strada	90-		281913		281002
888	Desmo Quattro	93		281913		281002
888	Strada/SP IV	90-		281913		281002
900	907 I.E	90-93		281913		281002
900	e	01-		281920		281006
900	MH E	01-02		281913		281002
900	Monster / Monster i.e	00-02		281920		281006
900	Paso 906	89		281913		281002
900	Sport	02-		281913		281002
900	SS	90-97		281913		281002
900	Superlight	92-97		281913		281002
900	Supersport	98-02		281920		281006
907	IE/Strada	91-		281913		281002
916	Biposto/Strada/SP/Senna-II	94-98		281913		281002
916	Monster S4	01-03		281920		281006
916	ST4	99-03		281920		281006
944	ST2	97-98		281913		281002
944	ST2	97-02		281920		281006
992	ST3	04-07		281920		281006
992	ST3 S ABS	06-07		281920		281006
996	916 SPS	97-98		281913		281002
996	Base/S	01-		281920		281006
996	R	01-		281913		281002
996	S4 R	03-05		281920		281006
996	SPS	99-00		281920		281006
996	ST4s	02-		281920		281006
996	ST4s ABS	01-05		281920		281006
998	Base/S	03-06		281920		281006
998	S/R	02-		281913		281002
998	SFE	04-		281913		281002
999	S/R	03-06		281920		281006
1000	D16 RR	07-		281920		281006
1000	GT	05-		281920		281006
1000	Mille Rep	84-		281913		281002
1000	Monster Dark I.E	03-05		281913		281002
1000	Monster S i.e	03-		281920		281006
1000	Multistrada DS	03-06		281913		281002
1000	Multistrada DS	06-		281920		281006
1000	Multistrada S DS	05		281913		281002
1000	S2 R	06-08		281920		281006
1000	S4 R	03-05		281920		281006
1000	S4 RS	06-		281920		281006
1000	Sport	05-		281920		281006
1000	SS	07-		281920		281006
1000	SS DS	03-06		281920		281006
1098	S/Tricolore	07-		281920		281006
1100	Hypermotard	07-		281920		281006
1100	Hypermotard S	07-		281920		281006
1100	Multistrada DS	07-08		281920		281006

E-TON ATV						
50	Viper Mini / RLX M	03-		281948		281018
70	Viper Mini /RLX M	03-		281948		281018
90	Viper R / RLX	03-		281948		281018
150	Challenge CLX	03-05		281919		
150	Challenger LXL	03-05		281919		
150	Viper RLX	05-		281919		
150	Viper ST EXL	05-	281948	281919	281018	
150	Yukon ST ELX	05-		281919		
250	Vector ST	06-	281948	281919	281018	
300	Vector ST	07-	281948		281018	
300	Vortex ST	07-	281948		281018	

Cyl. Cil.	Modèle Modello	Année Anno	TNT / RB Original		SKY SARKANY	
			Avant Ant.	Arrière Post.	Avant Ant.	Arrière Post.
FACTORY						
50	Phantom R 12	03-		281911		281000A
50	phantom R 14	03-		281911		281000A
50	RP Desert	04-	281947	281911		281000A
50	SM Chrono	04-		281911		281000A
50	SM Chrono	02-	281947			
50	SP Chrono	04-		281911		281000A
50	SP Chrono	04-	281947			
50	YR Desert	04-	281947	281911		281000A
125	YR CB	04-	281947			
250	YR	98-	281917		281004	

FACTORY ATV						
50	Helix	04-		281948		281018
50	Rex	04-		281948		281018
100	Helix	04-		281948		281018
100	Rex	04-		281948		281018

FANTIC						
50	Alien	98	281911		281000A	
50	Big wheel	94-	281949		281019	
50	Caballero RC	92-93		281915		
50	Caballero RC	94-	281947	281915		
50	Caballero RS	92-93		281915		
50	Clubman	95-	281911	281911	281000A	281000A
50	Fast		281921		281007	
50	FC 01	98-	281911		281000A	
50	Grinta	95-	281949		281019	
50	Grinta	97-	281949		281019	
50	Koala	88-	281915	281915		
50	K-Roo	92-93	281911	281911	281000A	281000A
50	Leader	95-	281949		281019	
50	Oasis	90-	281921	281915	281007	
50	Oasis Rally	86-	281921		281007	
50	Pony SR	93-	281949		281019	
50	Queenie	95-	281949		281019	
50	Regolarita Casa	07-	281947			
50	Supersei Motard	07-	281947			
50	Trial	92-	281911	281911	281000A	281000A
50	Trial 5,7,9	89-	281911	281911	281000A	281000A
75	Oasis	89-	281921		281007	
80	Caballero	98-	281930A		281009A	
80	Caballero & Oasis	90-93	281913		281002	
80	Caballero RC	94-		281915		
80	Clubman	95-	281911	281911	281000A	281000A
80	K-Roo	92-	281911	281911	281000A	281000A
80	Trial	92-	281911	281911	281000A	281000A
125	Trial,5	89	281911	281911	281000A	281000A
125	Trial,7	90-	281911	281911	281000A	281000A
125	Trial,9	90-	281911	281911	281000A	281000A
125	Caballero	98-	281930A		281009A	
125	Caballero RC	94-96		281915		
125	Clubman		281911	281911	281000A	281000A
125	Cruiser	98-	281913	281911	281002	281000A
125	Extra	98-	281930A		281009A	
125	K-Roo	92-	281911	281911	281000A	281000A
125	Raider	83-	281915			
125	Regolarita Casa	07-	281947			
125	Sport HP1	86-	281915			
125	Strada MK2	83-	281915			
125	Supersei Motard	07-	281947			
247	Trial	90-	281911	281911	281000A	281000A
250	Casta	98-	281911	281911	281000A	281000A
250	Clubman		281911	281911	281000A	281000A
250	Coach	92-94	281911		281000A	
250	Coach	95-	281911	281911	281000A	281000A
250	Coach	91-	281913		281002	
250	K Roo	93-	281911	281911	281000A	281000A
250	Raider	85-	281930A		281009A	
250	Section	96-	281911	281911	281000A	281000A
250	Trial/Coach	90-91	281911		281000A	
305	Trial	89-	281911	281911	281000A	281000A
307	Trial	91-	281911	281911	281000A	281000A
309	Trial	91-	281911	281911	281000A	281000A

GARELLI						
50	Big Racing	94-	281949		281019	
50	Big wheels	94-	281949		281019	
50	Ciclone LC	86-	281911		281000A	
50	Ciclone SM	86-	281911		281000A	

* Adaptable
* Adattabile

Les références du constructeur sont seulement indicatives et n'impliquent pas que les pièces de rechange viennent du constructeur.
I codici di riferimento originali sono indicativi e non implicano che i ricambi provengano necessariamente dalla stessa fabbrica del costruttore.

FREINAGE FRENI PLAQUETTES DE FREIN PASTIGLIE FRENO

Cyl. Cil.	Modèle Modello	Année Anno	TNT / RD Original		SKY SARHANY	
			Avant Ant.	Arrière Post.	Avant Ant.	Arrière Post.
50	CPM	02-	281949		281019	
50	Flo	00-	281910		281000	
50	FX	02-	281949		281019	
50	Koala	94-	281915	281915		
50	KRS	02-	282052Z		281020	
50	PMX Rally	00-	281949		281019	
50	PMX Sport	00-	282052Z		281020	
50	Pony	94-	281949		281019	
50	Pony SR	95-	281949		281019	
50	Queenie	95-	281948		281018	
50	Sahel	91-		281911		281000A
50	Sahel	97-	281921	281911	281007	281000A
50	SR	94-	281949		281019	
50	SR Pony		281948		281018	
50	Starter	02-	281949		281019	
80	MB	80-	281948		281018	
80	MCX	82-	281948		281018	
80	Sahel	89-	281921		281007	
125	Freeland	02-	282052Z		281020	
125	GTA	85	281913		281002	
125	GTA	86	281913		281002	
125	GTA	87-	281930A	281913	281009A	281002
125	Hawr	86-	281930A		281009A	
125	Panther	02-		281910		281000
125	Raider	02-	281948		281018	
125	Tiger XLE	87-		281915		
125	Tiger XLE	86-	281930A		281009A	
125	T-Rex	00-	282052Z		281020	
125	Trial section	95-	281911		281000A	
125	XR Tiger/XRD	85	281913		281002	
150	Freeland	02-	282052Z		281020	
150	Panther	02-		281910		281000
200	Hawr	86-	281930A		281009A	
249	Trial section	95-	281911	281911	281000A	281000A
250	Panther	02-		281910		281000
323	Trial	86-	281911		281000A	

GAS GAS						
Cyl. Cil.	Modèle Modello	Année Anno	Avant Ant.	Arrière Post.	Avant Ant.	Arrière Post.
50	ATV J	06-		281911		281000A
50	EC Rookie	01-04	281922		281008	
50	EC Rookie	05-	281947			
50	SM	05-	281947			
50	SM Rookie	01-	281922		281008	
50	TXT Boy	04-	281911	281911	281000A	281000A
80	EC	94-	281930A		281009A	
80	Enducross	94-	281917		281004	
80	IMX	96-	281917		281004	
125	Enducamp 4T	05-	281947			
125	Enducross	93-	281917		281004	
125	Enduro TT	93-	281917		281004	
125	JT 12	95-	281911	281911	281000A	281000A
125	JT R	96-	281911	281911	281000A	281000A
125	JT X	97-	281911	281911	281000A	281000A
125	MC	94-00	281917		281004	
125	Pampera	97-02	281911	281911	281000A	281000A
125	Pampera	03-	281947			
125	TT	95-	281917		281004	
125	TXT	99-	281911		281000A	
140	JTR Contact	96-	281911	281911	281000A	281000A
150	JT 16	95-	281911	281911	281000A	281000A
160	JT	95-	281911	281911	281000A	281000A
160	JT R	96-	281911	281911	281000A	281000A
200	EC	99-	281917	281917	281004	281004
200	Pampera	99-	281911	281911	281000A	281000A
200	TXT	99-	281911		281000A	
250	Contact JT	94-	281911	281911	281000A	281000A
250	Contact T 25	93	281911	281911	281000A	281000A
250	EC	97-99	281917		281004	
250	EC FSE	99-	281917		281004	
250	JT 25	91-	281911	281911	281000A	281000A
250	JT R Contact	96-	281911	281911	281000A	281000A
250	JT R Tarres Replica	96-	281911	281911	281000A	281000A
250	JT X	97-	281911	281911	281000A	281000A
250	MC	95-99	281917		281004	
250	Pampera	96-02	281911	281911	281000A	281000A
250	Pampera	02-	281930A		281009A	
250	Pampera	03-	281947			
250	TT	95-	281917		281004	
270	JT R Contact	96-97	281911	281911	281000A	281000A
270	JT X	97-	281911	281911	281000A	281000A

Cyl. Cil.	Modèle Modello	Année Anno	TNT / RD Original		SKY SARHANY	
			Avant Ant.	Arrière Post.	Avant Ant.	Arrière Post.
270	TXT	98-	281911	281911	281000A	281000A
280	Pampera	04-	281947			
300	EC	99-	281917		281004	
300	HP Wild	03-	281917	281917	281004	281004
320	JT 32	91-	281911	281911	281000A	281000A
320	JT X	97-	281911	281911	281000A	281000A
320	Pampera	99-	281911	281911	281000A	281000A
327	Trial	89-	281911	281911	281000A	281000A
350	JT	95-	281911	281911	281000A	281000A
370	JT R 37 Contact	96-	281911	281911	281000A	281000A
370	JT R37	96	281911	281911	281000A	281000A
400	HP Wild	03-	281917	281917	281004	281004
400	EC Enducamp	05-	281947			
400	EC FSE	99-00	281917		281004	

GAS GAS ATV						
Cyl. Cil.	Modèle Modello	Année Anno	Avant Ant.	Arrière Post.	Avant Ant.	Arrière Post.
250	KS RV DER	06-	281919			

GENERIC						
Cyl. Cil.	Modèle Modello	Année Anno	Avant Ant.	Arrière Post.	Avant Ant.	Arrière Post.
50	Explorer Cracker	05-	281930G		281015	
50	Ideo	05-	281930G		281015	
50	Roc	08-	281930G		281015	
50	Toxic	07-	281947	281915		
50	Trigger SM	06-	281947	281915		
50	Trigger X	06-	281947	281915		
50	Xor	05-	281930G		281015	
125	Ideo	05-	281930G		281015	
125	Soho	06-	281930G		281015	
125	Xor	05-	281930G		281015	

GILERA						
Cyl. Cil.	Modèle Modello	Année Anno	Avant Ant.	Arrière Post.	Avant Ant.	Arrière Post.
50	DNA	00-	281930H	281916	281006B	
50	Eaglet	97-	281910		281000	
50	GP	02-	281922	281911	281008	281000A
50	GPR Poggial Replica	03-	281922	281911	281008	281000A
50	GSM	00-	281911	281911	281000A	281000A
50	GSM Supermotard	01-	281911	281911	281000A	281000A
50	H@k	99-	281911	281911	281000A	281000A
50	Ice	01-	281910		281000	
50	NRG	94-	281910		281000	
50	Off Road R Six Speed	97-	281911	281911	281000A	281000A
50	R	93-	281910		281000	
50	RCR	04-	281911	281911	281000A	281000A
50	RT Fun	93-	281910		281000	
50	Runner	97-00	281910		281000	
50	Runner DD	98-	281910	281916	281000	
50	Runner PJ	06-	281930H	281916	281006B	
50	Runner SP	98-05	281910		281000	
50	Runner SP	06-	281947			
50	SMT	04-	281911	281911	281000A	281000A
50	Stalker	97-	281910	281916	281000	
50	Storm	94-95	281910		281000	
50	Surfer	00-	281911		281000A	
50	Typhoon	94-	281910		281000	
50	Zulu	01-	281911	281911	281000A	281000A
80	Typhoon	95-	281910		281000	
125	Apache	91-		281918		281005
125	Arizona Hawk	86-	281913		281002	
125	Cougar	99-	281930A		281009A	
125	DNA	01-	281930H	281910	281006B	281000
125	ER Rally	87-	281930A		281009A	
125	ES RV	87-		281913		281002
125	Fast Bike	88-	281930A		281009A	
125	FX Runner	97-99	281922		281008	
125	FX Runner (hengtong)	00-	281930H		281006B	
125	FX Runner / SP (Grimeca Cal)	00-		281916		
125	FX Runner / SP (Hengtong cal)	00-		281916		
125	FX SP Runner (hengtong)	97-	281930H		281006B	
125	GFR	93-94		281913		281002
125	GSM (SM3)	00-	281911	281911	281000A	281000A
125	HE	83-	281913		281002	
125	HX	83-	281913		281002	
125	KK	86-		281913		281002
125	KK APTS	87-		281913		281002
125	KK/KR/KZ	86-	281930A	281913	281009A	281002
125	KZ / KZ Endurance	86		281913		281002
125	KZ Endurance	88-	281930A		281009A	
125	KZ MXR MR1	88-		281913		281002
125	LC	83-	281913		281002	
125	MRX			281913		281002

FREINAGE FRENI PLAQUETTES DE FREIN PASTIGLIE FRENO

Cyl. Cil.	Modèle Modello	Année Anno	TNT / RD Original		SKY SARHANY	
			Avant Ant.	Arrière Post.	Avant Ant.	Arrière Post.
125	MXR	89-		281913		281002
125	MX1	88-		281913		281002
125	MXR	90-	281930A		281009A	
125	Nexus	07-	281930H	281930H	281006B	281006B
125	R1	88-		281913		281002
125	R1 S	88-		281913		281002
125	R1/R1S	90-	281930A		281009A	
125	RC Crono/Freestyle/CX	91-		281913		281002
125	RC Rally	87-		281913		281002
125	RC Top Rally	89-91		281918		281005
125	RRT Nebraska	87-	281930A		281009A	
125	RTX	86-	281930A		281009A	
125	RTX FastBike	87-		281913		281002
125	Runner FX	97-	281947			
125	Runner FX SP	00-	281947			
125	Runner SP	99-	281947			
125	RV	83-86	281913		281002	
125	RX_Arizona	83-	281913		281002	
125	RX Arizona Hawk	85-	281930A		281009A	
125	Saturno Puma	90-		281911		281000A
125	SC	06-		281911		281000A
125	SP 01	89-		281913		281002
125	SP 02	90-		281913		281002
125	SP Runner (hengtong)	99-	281930H		281006B	
125	Surfer	01-	281911	281911	281000A	281000A
125	TX 1	88-		281913		281002
125	Typhoon	95-	281910		281000	
125	VX Runner 4T (hengtong)	01-	281930H		281006B	
125	VX Runner 4T Grimeca cal	01-	281947			
125	X1	89-	281930A	281915	281009A	
125	XR1	88-		281913		281002
125	XR2	90-	281930A		281009A	
125	XR2/SP01/02/Sport/Freestyle	90-		281913		281002
150	FX Runner	97-	281922		281008	
150	FX Runner (hengtong)	97-02	281930H		281006B	
150	Runner FX	97-02	281947			
175	Mad Mud	02-	281930H	281910	281006B	281000
180	DNA	01-	281930H	281910	281006B	281000
180	FXR Runner	97	281922		281008	
180	FXR Runner	98	281947			
180	FXR Runner (hengtong)	00-	281930H		281006B	
180	FXR Runner / SP(Grimeca cal)	00-	281947	281916		
180	FXR Runner / SP(Hengtong cal)	00-	281947	281916		
180	Mad Mud	02-	281930H		281006B	
180	Runner	01-	281922		281008	
180	Runner SP (hengtong)	00-	281930H		281006B	
180	Runner VXR (hengtong)	01-	281930H		281006B	
180	VXR Runner 4T Grimeca cal	01-	281947			
200	Arizona	83-	281913		281002	
200	Arizona Hawk	85-	281930A		281009A	
200	ER	87-	281930A		281009A	
200	Fast Bike	87-	281930A	281913	281009A	281002
200	FX Runner	97-98	281922		281008	
200	FX Runner SP	98-	281947			
200	FX Runner SP (Grimeca Cal)	98-		281916		
200	FX Runner SP (Hengtong Cal)	98-		281916		
200	RTX	86-		281913		281002
200	Runner FX SP (hengtong)	98-	281930H		281006B	
200	Runner VRX	06-	281947			
200	Runner VXR 4T	06-	281930H		281006B	
200	RV AE	87-		281913		281002
200	RV ES	87-		281913		281002
200	RX	83-	281913		281002	
200	Stalker	97-	281910	281916	281000	
200	VRX Runner 4T	01-	281930H		281006B	
200	VXR Runner 4T Grimeca cal	01-	281947			
250	Arizona Hawk	86-	281913		281002	
250	Arizona Rally	86-	281913		281002	
250	HX LC	83-	281913		281002	
250	NE	83-	281913		281002	
250	Nexus I,E	06-	281917	281920	281004	281006
250	Nexus I,E	07-	281930H		281006B	
250	NGR	85-		281913		281002
250	NGR	87-	281915			
250	NX	83-	281913		281002	
250	Rally	86-	281913		281002	
350	Dakota	86	281930A		281009A	
350	Saturno Bialbero			281913		281002
350	Trial	86-	281911		281000A	
350	XRT	90-	281930A	281913	281009A	281002

Cyl. Cil.	Modèle Modello	Année Anno	TNT / RD Original		SKY SARHANY	
			Avant Ant.	Arrière Post.	Avant Ant.	Arrière Post.
491	Nordwest	94-		281913		281002
500	Bialbero	91-		281913		281002
500	Dakota	86-	281930A		281009A	
500	Fuoco I,E	07-	281916	281930H		281006B
500	NEXUS	04-	281917	281920	281004	281006
500	Nexus I,E SP	06-	281917	281920	281004	281006
500	Saturno 491	89-		281913		281002
500	XRT Saturno Piuma	90-		281913		281002
600	RC	89-90		281918		281005
600	RC	88-	281930A		281009A	
600	RC / Nordwest Nordcape	92-		281913		281002
600	RC Four Valve	91-		281918		281005
600	RC R	92-93		281918		281005
600	RC Top Rally	90-		281918		281005
600	Supersport	02-		281920		281006
600	XRT	88-		281913		281002
600	XTR	89-	281930A		281009A	
800	GP	08-	281917	281930H	281004	281006B

HIGHLAND

950	V2 Motard (SM3)	00-	281917		281004	
950	V2 Outback	00-	281917		281004	

HM

50	CRE BAJA	03-	281947	281911		281000A
50	CRE SIX	99-02	281947			
50	CRE SIX	03-	281947	281911		281000A
50	Derapage	03-	281947	281911		281000A

HONDA

50	Aero	88-	281930M			
50	CRE	96-	281930A		281009A	
50	Dream	-01	281919			
50	Formula	94-	281910		281000	
50	MBX 5W	85-	281930M			
50	MBX FW	85-	281930M			
50	MBX FWD	85-	281930M			
50	MBX S	83-	281930M			
50	NS-1	91-	281930M			
50	NS-1 Replica	-96	281919			
50	NSF Aero	88-	281930M			
50	NSR	88-93	281930M			
50	NSR	94-95	281930M			
50	SFX/SFX Sport	95-	281910		281000	
50	SGX Sky	97-	281910		281000	
50	SH City Express	94-95	281930A		281009A	
50	SH Scoopy	96-	281910		281000	
50	SJ Bali	93-	281930A		281009A	
50	SXR	98-	281910		281000	
50	X8R S / X	98-	281910		281000	
50	XR Motard	-05	281919			
75	Hurricane	82-	281930C		281011	
75	Hurricane	83-	281930M			
75	NS-1	92-	281919			
75	NSR	-92	281922		281008	
75	NSR F II	88-91	281930M			
75	Replica	-92	281919			
80	MB	80-	281948		281018	
80	MBX	86-	281930C		281011	
80	MBX	83-	281930M			
80	MBX DX	82-	281930M			
80	MBX SW	83-	281930M			
80	MBX SWD	83-	281930M			
80	MCX	82-	281948		281018	
80	MCX S	82-	281930M			
80	MTX R	87-	281930C		281011	
80	NSR R	87-	281930M			
100	EX Bali	96-	281930A		281009A	
100	Lead	00-	281930C		281011	
100	NSF Aero	-07	281919			
100	Scoopy	96-	281910		281000	
100	SJ Bali	97-	281930A		281009A	
100	XR Motard	-05	281919			
125	CA Rebel	97-	281930A		281009A	
125	CBX		281922		281008	
125	CBX Custom	88-	281930M			
125	CH Spacy	94-	281930D		281012	
125	CR R	84-86	281930C		281011	
125	CR RE/RF	84-85	281930C		281011	
125	CR RG	86-	281930C		281011	

* Adaptable
* Adattabile

Les références du constructeur sont seulement indicatives et n'impliquent pas que les pièces de rechange viennent du constructeur.
I codici di riferimento originali sono indicativi e non implicano che i ricambi provengano necessariamente dalla stessa fabbrica del costruttore.

FREINAGE FRENI PLAQUETTES DE FREIN PASTIGLIE FRENO

Cyl. Cil.	Modèle Modello	Année Anno	TNT / RPD Original		SKY SARKANY	
			Avant Ant.	Arrière Post.	Avant Ant.	Arrière Post.
125	CRM	90-	281930A		281009A	
125	CRM R	90-98		281913		281002
125	Dylan	02-	281930D		281012	
125	MBX F	84-	281930M			
125	MBX RWB	84-	281930M			
125	MTX	87	281930C		281011	
125	MTX Camel Italy	88-	281930A		281009A	
125	MTX R	84-	281930C		281011	
125	MTX R Italy	86	281930A		281009A	
125	NES @	01-	281930C		281011	
125	NS Italy	85-88	281930A		281009A	
125	NSR F	80-90	281930A		281009A	
125	NSR F	88-89	281930C		281011	
125	NSR F/R	89-		281913		281002
125	NSR R Italy	89-	281930A		281009A	
125	NX Transcity	90-	281930A		281009A	
125	PS I	06-	281930D		281012	
125	PS R	90		281913		281002
125	RTV NSR Italy	87-	281930A		281009A	
125	Scoopy	01-05	281930D		281012	
125	SH	02-	281930D		281012	
125	Shadow	-99	281919			
125	Silver Wing / ABS	07-	281931	281931A		
125	Spacy	98-	281930C		281011	
125	Varadero	-01	281919			
125	VT Shadow	99-	281930A		281009A	
125	XL R	86-88	281930C		281011	
125	XL R/PD Italy	85-	281930A		281009A	
125	XL R/PD/Italy EX	87-	281930A		281009A	
125	XL Varadero	01-	281919			
150	Dylan	02-	281930D		281012	
150	NES @	01-	281930C		281011	
150	PS I	06-	281930D		281012	
150	Scoopy	01-05	281930D		281012	
150	SH	02-	281930D		281012	
150	Silver Wing	07-	281931	281931A		
200	MTX R	85-	281930C		281011	
200	XL R/PD Italy	85-	281930A		281009A	
223	FTR	00-02	281930D		281012	
250	ATC R	85-86	281930C	281930C	281011	281011
250	CA Rebel	90-95	281919			
250	CBF	04-	281919			
250	CR R	84-86	281930C		281011	
250	CR RE/RF	85-	281930C		281011	
250	CR RG	86-	281930C		281011	
250	Forza	05-	281931	281931A		
250	FTR	86-	281930C		281011	
250	Fusion	90-	281930D		281012	
250	Jazz	05-	281931	281931A		
250	Rebel	85-	281930M			
250	Spacy	85-	281930C		281011	
250	Spazio	88-89	281930C		281011	
250	XR R	84-87	281930C		281011	
300	Innova	06-	281931	281931A		
300	SH	06-	281931	281931A		
350	XL R	84-85	281930C		281011	
350	XR R	84-85	281930C		281011	
500	CR R	84	281930C		281011	
500	CR RE / RG / RF	84-86	281930C		281011	
500	CT R	84-	281930C		281011	
500	XL R / RR	83-	281930C		281011	
500	XR R	84-	281930C		281011	
500	XR R Pro Link	83-84	281930C		281011	
600	XL LC	83-85	281930C		281011	
600	XL LM	86-	281930C		281011	
600	XL LMH / MLM	87-	281930C		281011	
600	XL R	83-87	281930C		281011	
600	XL RD	83-85	281930C		281011	
600	XL RG	86	281930C		281011	
600	XL RM	86	281930C		281011	
600	XR R	83-	281930C		281011	
600	XR R	84-86	281930M			
650	Dominator	97	281917		281004	
700	xl /v Transalp	08-	281931			
1000	CBF ABS	06-	281931	281931		

HONDA ATV						
200	ATC R	85-	281930C	281930C	281011	281011
250	ATC R	85-86	281930C	281930C	281011	281011
250	TRX R	87-89	281930C		281011	

Cyl. Cil.	Modèle Modello	Année Anno	TNT / RPD Original		SKY SARKANY	
			Avant Ant.	Arrière Post.	Avant Ant.	Arrière Post.
350	ATC	85-	281930C		281011	

HRD						
50	Sonic 2 supermotard / trail	00-02	281922	281911	281008	281000A
125	Formula LS	86-	281915	281915		
125	Platino SL	86-	281915	281915		
125	Platino ST	86-	281913		281002	
125	Road ST	86-	281913		281002	
125	Silver House	86-	281915	281915		
125	Silver House RS	86-	281915	281915		
125	Supermotard	00-02	281922	281911	281008	281000A

HUSABERG						
350	FC	95-99	281917		281004	
350	FE	94-99	281917		281004	
400	FC	94-99	281917		281004	
400	FE	94-98	281917		281004	
400	FE	00-	281917		281004	
400	FE E	99-03	281917		281004	
450	FC	03-	281917		281004	
450	FC	04-	281917		281004	
450	FE	04	281917		281004	
450	FE E	04-	281917		281004	
470	FC	02-07	281917		281004	
470	FC E	02-07	281917		281004	
470	FX	02-07	281917		281004	
470	FX E	02-07	281917		281004	
500	Cross	93	281917		281004	
501	FC	94-99	281917		281004	
501	FE	94-99	281917		281004	
501	FE E	99-04	281917		281004	
550	FC	03-	281917		281004	
550	FE	04-	281917		281004	
550	FE E	04-	281917		281004	
600	FC	94-99	281917		281004	
600	FE	94-99	281917		281004	
600	FE E	99-	281917		281004	
650	FC	04-	281917		281004	
650	FE	04-	281917		281004	
650	FE E	02-	281917		281004	
650	FX E	01-	281917		281004	

HUSQVARNA						
50	SM / WR	02-	281922	281911	281008	281000A
125	CR	94-	281917		281004	
125	CR	84-90	281913		281002	
125	CX	84-85	281913		281002	
125	SM (SM3)	98-99	281917		281004	
125	SM S (SM3)	00-	281917		281004	
125	WR	94-	281917		281004	
125	WRE	94-00	281917		281004	
125	WRE SM (SM3)	99-	281917		281004	
125	WXE	07-	281922		281008	
200	Prof	86-	281913	281913	281002	281002
240	CR	84-	281913		281002	
240	CX	84-	281913		281002	
250	CR	85-87	281913		281002	
250	CR	94-	281917		281004	
250	TC/TE All models	02-	281917		281004	
250	WR	84-86	281913		281002	
250	WR	94-00	281917		281004	
250	XC	85-	281913		281002	
350	TE	94-99	281917		281004	
360	WR	97-	281917		281004	
400	TE	01-	281917		281004	
400	WR	84-	281913		281002	
400	WR E	85-	281913		281002	
410	TE	96-	281917		281004	
450	TC	02-	281917		281004	
450	TE	05-	281917		281004	
500	CR	84	281913		281002	
500	XC	84-	281913		281002	
500	TC	86-	281913		281002	
500	XC	84-	281913		281002	
504		83-86	281913		281002	
510	TC	04-	281917		281004	
510	TE	95-	281917		281004	
510	TE	86-	281913		281002	
570	TE	00-	281917		281004	
610	TC	97-	281917		281004	

FREINAGE FRENI PLAQUETTES DE FREIN PASTIGLIE FRENO

Cyl. Cil.	Modèle Modello	Année Anno	TNT / RD Original		SKY SARHANY	
			Avant Ant.	Arrière Post.	Avant Ant.	Arrière Post.

610	TE	97-	281917		281004	
-----	----	-----	--------	--	--------	--

HYOSUNG						
50	Avanti	99-	281948		281018	
50	Fast SF	00-	281948		281018	
50	Rush	97-	281948		281018	
50	SB	00-	281948		281018	
50	SD	00-	281948		281018	
50	Sense	98-	281948		281018	
50	SF	99-	281948		281018	
50	SF Ally	03-	281948		281018	
50	Super cab	95-	281948		281018	
50	Super cab plus	98-	281948		281018	
100	Cab	98-	281948		281018	
100	EZ	98-	281948		281018	
110	FX	02-	281948		281018	
110	Master	04-	281948		281018	
110	Midas plus	98-	281948		281018	
125	Aquila	03-	281930M			
125	Aquila Classic	06-	281930M			
125	Boomer	03-	281910		281000	
125	Comet	02-	281930M			
125	Comet R	06-	281930M			
125	Exceed	02-	281910		281000	
125	GPS D	00-	281910		281000	
125	Grand prix	98-	281910		281000	
125	Hyper	99-	281910		281000	
125	Karion	02-	281930M			
125	XRX	00-	281930M			
150	Exceed	02-	281910		281000	
150	Grand prix	98-	281910		281000	
250	Aquila	03-	281930M			
250	Aquila V-Twin	02-	281930M			
250	Comet	02-	281930M			
250	Comet R	06-	281930M			
250	GV	04-	281930M			
400	XRX	05-	281930M			
600	Comet	03-	281930M			
650	Aquila	04-	281930M			
650	Comet	04-	281930M			
650	Comet R	05-	281930M			
650	Comet S	05-	281930M			
650	GT R	05-	281930M			
650	GT S	05-	281930M			
650	GT X	07-	281930M			
650	GV	04-	281930M			

ITALJET						
50	Bazooka	93-	281949		281019	
50	Cruise	94-	281949		281019	
50	Dragster	99-	281911	281911	281000A	281000A
50	Formula	94-99	281910	281910	281000	281000
50	Formula Air	99-	281911	281911	281000A	281000A
50	Formula LC	00-	281910	281910	281000	281000
50	Formula LC	98-	281911	281911	281000A	281000A
50	Formula RACE	95-	281911	281911	281000A	281000A
50	Jet Set	02-	281921A			
50	Pista 2	92-	281949		281019	
50	Scoop	93-	281949		281019	
50	SM	02-	281922		281008	
50	Torpedo	97-	281911		281000A	
50	Velocifero	94-	281911		281000A	
50	Yankee 8	94-	281949	281949	281019	281019
80	Formula	95-	281911	281921	281000A	281007
100	Millenium	02-	281921A			
100	Millenium	00-01	281948		281018	
125	Dragster	97-	281911	281911	281000A	281000A
125	Formula	96-	281911	281911	281000A	281000A
125	Jack	07-	281930D	281930D	281012	281012
125	Jet Set	02-	281921A			
125	Jupiter	02-	281930K	281917A	281010A	
125	Millenium	-00	281918		281005	
125	Millenium	02-	281921A			
125	Millenium	00-01	281948		281018	
125	SM	02-	281922		281008	
125	Torpedo	99-	281911		281000A	
125	Torpedo	07-	281930D		281012	
125	Twin	99-	281911	281911	281000A	281000A
150	Jack	07-	281930D	281930D	281012	281012
150	Jet Set	02-	281921A			

Cyl. Cil.	Modèle Modello	Année Anno	TNT / RD Original		SKY SARHANY	
			Avant Ant.	Arrière Post.	Avant Ant.	Arrière Post.

150	Jupiter	02-	281930K	281917A	281010A	
150	Millenium	-00	281918		281005	
150	Millenium	02-	281921A			
150	Millenium	00-01	281948		281018	
150	Torpedo	00-	281911		281000A	
180	Dragster	99-	281911	281911	281000A	281000A
250	Dragster	07-	281921A	281921A		
250	Jupiter	02-	281930K		281010A	
350	Boss	83-	281913		281002	
350	Road Master	83-	281913		281002	
650	Bazooka	06-	281930M			
650	Grifon	06-	281930M			
900	Grifon	00-		281913		281002

JCM						
125	Europa	89-	281911	281911	281000A	281000A
125	SR	89-	281911	281911	281000A	281000A
240	Europa	89-	281911	281911	281000A	281000A
240	SR	89-	281911	281911	281000A	281000A
325	Europa	89-	281911	281915	281000A	
325	SR	89-	281911	281911	281000A	281000A

JINCHENG						
50	JC Q 5	05-	281949		281019	
50	JC Q 9	05-	281949		281019	
50	Velos	05-	281922		281008	
70	JC Q 5	05-	281949		281019	
70	JC Y	05-	281949		281019	
90	JC 90-7 Gorilla	05-	281949		281019	
125	JC S Raccoon	05-		282052Z		281020
250	JC	-	282052Z		281020	

KAWASAKI						
50	KMX	88-	281948		281018	
50	KSR 1	90-	281948	281948	281018	281018
80	AR	81-	281948		281018	
80	KD N1	88-90	281948		281018	
80	KD N3	88-90	281948		281018	
80	KMX	87-	281948		281018	
80	KSR 2	90-		281948		281018
80	KX	89-	281948		281018	
80	KX	91-92	281948		281018	
80	KX E	84-87	281948		281018	
80	KX G	84-87	281948		281018	
80	KX H	84-87	281948		281018	
80	KX J	84-87	281948		281018	
80	KX L	88-96	281948		281018	
80	KX N	88-96	281948		281018	
80	KX R-R6	88-96	281948		281018	
100	KX	88-96	281948		281018	
100	KX B5	88-96	281948		281018	
125	BN	-05	281919			
125	Eliminator	97-	281948		281018	
125	KDX A	90-	281948		281018	
125	KDX B	90-	281948		281018	
125	KDX SR	90-	281948		281018	
125	KMX	89-98	281948		281018	
125	KX B1	82-	281948		281018	
200	KDX C1	86-88	281930M			
200	KMX A2	88-92	281948		281018	
200	KMX A3	88-92	281948		281018	
200	KMX A4	88-92	281948		281018	
250	Epsilon	03-		281930D		281012
250	Epsilon	03-	281930J		281016	
250	KX B1	82-	281948		281018	
250	KZF	88-		281948		281018
250	ZXR	08-	281919	281919		

KAWASAKI ATV						
250	KXT A1 Tecate	84-		281948		281018
300	KLF C1-C12 Bayou (right)	89-01	281919			
400	KLF B1-B7 Bayou (right)	93-99	281919			
650	KVF Brute Force 4x4 (right)	05-	281919			
750	KFX Brute Force 4x4	04-	281919			
750	KVF Brute Force 4x4 (right)	05-	281919			

KEEWAY						
50	F Act / Racing	07-	281930G		281015	
50	Flash	07-	281930G		281015	
50	Focus	05-	281930G		281015	

* Adaptable
* Adattabile

Les références du constructeur sont seulement indicatives et n'impliquent pas que les pièces de rechange viennent du constructeur.
I codici di riferimento originali sono indicativi e non implicano che i ricambi provengano necessariamente dalla stessa fabbrica del costruttore.

FREINAGE FRENI PLAQUETTES DE FREIN PASTIGLIE FRENO

Cyl. Cil.	Modèle Modello	Année Anno	TNT / RÖ Original		SKY SARKANY	
			Avant Ant.	Arrière Post.	Avant Ant.	Arrière Post.
50	Goccia	07-	281910		281000	
50	Hacker	08-	281910		281000	
50	Hurricane	05-	281930G		281015	
50	Hurricane	04-	281948		281018	
50	Matrix	05-	281930G		281015	
50	Pixel	08-	281948		281018	
50	Swan	05-	281948		281018	
50	X-Ray	07-	281947			
50	X-Ray SC Supermoto	07-	281947			
125	F ACT / Racing	08-	281930G		281015	
125	Focus	07-	281948		281018	
125	K2	07-	281930H	281930H	281006B	281006B
125	Matrix	07-	281930G		281015	
125	Matrix	06-	281948		281018	
125	Silver Blade	07-	281917	281920	281004	281006
125	Viva	05-	281930G	281930G	281015	281015
125	Viva 2	05-		281930G		281015
150	K2	07-	281930H	281930H	281006B	281006B
150	Silver Blade	07-	281917	281920	281004	281006
150	Viva 2	05-		281930G		281015
250	K2	07-	281930H	281930H	281006B	281006B
250	Silver blade	07-	281917	281920	281004	281006

KRAM IT						
250	GS	97-	281917		281004	
250	MX	97-	281917		281004	

KTM						
50	EXC	99-	281922	281911	281008	281000A
50	GO	95-	281921		281007	
50	Scooter	94-	281910		281000	
60	SX	99-	281911		281000A	
60	SX	00-01		281915		
65	SX	00-01	281911		281000A	
65	SX	00-03		281915		
80	MX	86-91	281913		281002	
80	PL Watercooled		281913	281913	281002	281002
80	RLW	80-	281913	281913	281002	281002
80	RSL/L/RS/RL/Bora/Chopper	80-	281913	281913	281002	281002
80	Watercooled	86-91	281913		281002	
85	MX	90	281913		281002	
125	EGS	95-03	281917		281004	
125	Enduro	93-	281917		281004	
125	Enduro	88-91	281930A	281930A	281009A	281009A
125	Euro Trail	96-	281917		281004	
125	EXC	95-	281917		281004	
125	EXE	01	281917		281004	
125	GS	93-	281917		281004	
125	LC/MX/XC	85	281913		281002	
125	LC/MX/XC	86-	281913	281913	281002	281002
125	LC2	97-99	281917		281004	
125	MX	88	281930A	281930A	281009A	281009A
125	MX	92-95	281917		281004	
125	MXC	92-93	281917		281004	
125	SM (sm3)	00-	281917		281004	
125	SX	93	281917		281004	
125	SX	94-03	281917		281004	
125	SX	04-	281917		281004	
144	SX	08-	281917		281004	
200	EGS	99-02	281917		281004	
200	EXC	98-03	281917		281004	
200	EXC	04-	281917		281004	
200	SX	02-03	281917		281004	
200	SX	04-	281917		281004	
250	Baja	86-	281913		281002	
250	EGS	93	281917		281004	
250	EGS	94-02	281917		281004	
250	Enduro	88-91	281930A	281930A	281009A	281009A
250	EXC	93	281917		281004	
250	EXC	94-02	281917		281004	
250	EXC 4T	03-	281917		281004	
250	EXC Enduro / 4t	99-03	281917		281004	
250	EXC Enduro / 4t	04-	281917		281004	
250	GS	89-90	281930A	281930A	281009A	281009A
250	LC/MX	86	281913	281913	281002	281002
250	LC/MX/XC	85	281913		281002	
250	MC/MX	83-84	281913	281913	281002	281002
250	MX	92-93	281917		281004	
250	MX	03-	281917		281004	
250	MX C	92-93	281917		281004	

Cyl. Cil.	Modèle Modello	Année Anno	TNT / RÖ Original		SKY SARKANY	
			Avant Ant.	Arrière Post.	Avant Ant.	Arrière Post.
250	SX	93-	281917		281004	
250	SX	94-02	281917		281004	
250	SX F	06-	281917		281004	
250	XC	85	281913		281002	
250	XC	86-89	281913	281913	281002	281002
300	EGS	93-03	281917		281004	
300	EXC	93-	281917		281004	
300	EXC Enduro	93-	281917		281004	
300	GS	86-90	281913	281913	281002	281002
300	MX	92-	281917		281004	
300	MXC	92-93	281917		281004	
300	MXC	04-	281917		281004	
300	SX	93-03	281917		281004	
300	XC	85	281913		281002	
300	XC	86-90	281913	281913	281002	281002
350	Country Cross	85-	281913		281002	
350	Enduro	88-	281930A	281930A	281009A	281009A
350	GS	83-	281913		281002	
350	GS4/K4/XC/MC	-83	281913		281002	
350	LC4 EXC	94-	281917		281004	
350	MX	92-	281917		281004	
360	EXC	96-97	281917		281004	
360	MX	96-97	281917		281004	
360	SX	96-97	281917		281004	
380	EXC	98-	281917		281004	
380	MX	98-	281917		281004	
380	SX	98-02	281917		281004	
390	GS	83-	281913		281002	
390	MC/XC	-83	281913		281002	
400	EGS/EGS-E	97-98	281917		281004	
400	EXC	04-	281917		281004	
400	EXC Racing	00-	281917		281004	
400	LC4	93-95	281917		281004	
400	LC4 E	99-00	281917		281004	
400	LC4 SC	96-97	281917		281004	
400	SC	97-98	281917		281004	
400	SX Racing	00-02	281917		281004	
400	SXC Tiainen replica	97-	281917		281004	
420	MC/XC	-83	281913		281002	
440	SX	94-	281917		281004	
450	EXC	03-	281917		281004	
450	EXC Racing	04-	281917		281004	
450	MXC	04-	281917		281004	
450	SX	03-	281917		281004	
450	SX F	07-	281917		281004	
495	MC/MX Leleu	82-83	281913		281002	
500	GS	89-	281930A	281930A	281009A	281009A
500	GS Enduro	83-	281913		281002	
500	K4	83-	281913		281002	
500	LC/MX	85	281913		281002	
500	LC/MX	86-	281913	281913	281002	281002
500	MX	92-93	281917		281004	
500	MX	88	281930A	281930A	281009A	281009A
500	MXC	92-93	281917		281004	
500	SX	93-	281917		281004	
500	XC/MC	-83	281913		281002	
505	SX	07-	281917		281004	
520	EXC Racing	00-02	281917		281004	
520	SX Racing	00-02	281917		281004	
525	EXC	03-	281917		281004	
525	EXC Racing	03-	281917		281004	
525	MXC	04-	281917		281004	
525	MXC Desert	03-	281917		281004	
525	SX	03-	281917		281004	
525	SX Racing	03-	281917		281004	
530	EXC R	08-	281917		281004	
540	SXC Tiainen Replica	99-00	281917		281004	
550	MG	94-	281917		281004	
550	MXC	92-93	281917		281004	
550	XC	94-	281917		281004	
600	4T Enduro	84-	281913		281002	
600	4T GS	93	281917		281004	
600	4T GS	94-	281917		281004	
600	Baja	86-	281913	281913	281002	281002
600	Enduro Incas	88-	281930A	281930A	281009A	281009A
600	Enduro LC4	88-	281930A	281930A	281009A	281009A
600	GS	85	281913		281002	
600	LC4 Six days	92-	281917		281004	
620	Duke	94-98		281913		281002
620	LC4 EGS	94-	281917		281004	

FREINAGE FRENI PLAQUETTES DE FREIN PASTIGLIE FRENO

Cyl. Cil.	Modèle Modello	Année Anno	TNT / RD Original		SKY SARHANY	
			Avant Ant.	Arrière Post.	Avant Ant.	Arrière Post.
620	LC4 EGS-E Adventure	97-	281917		281004	
620	LC4 EXC	94-	281917		281004	
620	LC4 Ralle	97-	281917		281004	
620	LC4 SC	94-	281917		281004	
620	LC4 SX	94-	281917		281004	
620	Rallye	98	281917		281004	
625	EXC	03-	281917		281004	
625	LC4 SC Supermoto(SM3)	01-02	281917		281004	
625	LC4 SXC	03-	281917		281004	
625	SX	03-	281917		281004	
640	Duke	99-02		281913		281002
640	LC4 Adventure R	99-06	281917		281004	
640	LC4 Enduro	99-	281917		281004	
640	LC4 Supermoto (SM3)	99-02	281917		281004	
660	LC4 Rallye	02-	281917		281004	
690	Enduro	06-	281917		281004	
950	Adventure S	03-		281917		281004
950	LC8 Adventure	03-	281917		281004	
950	R Super Enduro	06-		281917		281004
950	SM	05-		281917		281004
950	Supermoto	05-		281917		281004
950	Supermoto R	07-		281917		281004
990	Adventure	06-		281917		281004
990	R Super Enduro	06-		281917		281004
990	Supermoto	08-		281917		281004
1190	RC 8	08-		281920		281006

KYMCO						
Cyl. Cil.	Modèle Modello	Année Anno	Avant Ant.	Arrière Post.	Avant Ant.	Arrière Post.
50	Activ SR	08-	281930M			
50	Activ	04-	281919			
50	Agility	05-	281919			
50	Bet&Win	01-	281919	281919		
50	Bet&Win	04-	281919			
50	Calypso	97-	281930G		281015	
50	Dink	97-	281919			
50	Dink Sport	99-	281919			
50	Grand Dink	04-	281919			
50	Heroism	97-	281930G		281015	
50	Nexxon	07-	281930C	281919	281011	
50	Spacer	99-	281919			
50	Super 9	00-	281919			
50	Super 9 AC	02-	281919			
50	Super 9 LC	02-	281919			
50	Yager	01-	281919			
100	Cobra	99-	281919			
100	Spike	02-	281922		281008	
110	Activ	04-	281919			
110	AXR	04-	281919			
110	Spike	03-	281922		281008	
125	Activ	04-	281919			
125	Agility	06-	281919			
125	Bet&Win	99-	281919	281919		
125	Calypso	99-	281930G		281015	
125	Cruiser	99-	281919			
125	Dink	96-	281919	281919		
125	Freeway	93-95	281915			
125	Grand dink	02-	281919	281919		
125	Heroism	95-	281930G		281015	
125	Hipster	00-	281919			
125	Joyride	01-		281919		
125	Movie	99-	281919			
125	Movie XL	01-	281919			
125	Nexxon	07-	281930C	281919	281011	
125	Pulsar	03-	281919			
125	Quannon	07-	281919	281919		
125	Spacer	99-	281919	281919		
125	Spike	04-	281919	281919		
125	Straight	05-	281919			
125	Straight	07-	281930C	281919	281011	
125	Super 9	00-	281919			
125	Yager	01-	281919	281919		
125	Zing	97-03	281919			
125	Zing 2	04-	281919			
150	Bet&Win	00-	281919	281919		
150	Custom DX	94-	281930M			
150	Dink	97-	281919	281919		
150	Grand Dink	02-	281919	281919		
150	Heroism	94-	281930G		281015	
150	Hipster	00-	281919			
150	Movie XL	01-	281919			

Cyl. Cil.	Modèle Modello	Année Anno	TNT / RD Original		SKY SARHANY	
			Avant Ant.	Arrière Post.	Avant Ant.	Arrière Post.
150	NSR	94-	281919	281919		
150	Spacer	99-	281919	281919		
150	Straight	05-	281919	281919		
150	Yager	01-	281919	281919		
150	Zing	96-	281919			
200	Dink	04-	281919	281919		
200	Yager	04-	281919	281919		
250	Bet&Win	00-	281919	281919		
250	Grand Dink	01-04	281919	281919		
250	People	05-	281919	281917A		
250	People	03-	281919			
250	People S	06-	281919	281917A		
250	Super 9	00-	281919			
250	Yup	02-	281919	281919		
300	People DX	08-	281919	281917A		

LAVERDA						
Cyl. Cil.	Modèle Modello	Année Anno	Avant Ant.	Arrière Post.	Avant Ant.	Arrière Post.
125	Curide	86-	281913		281002	
125	Custom	86-	281913		281002	
125	GS Lesmo	86-		281915		
125	LB Uno	85-	281913		281002	
125	Navarro	90-		281913		281002
350	GS Lesmo	86-	281913		281002	
350	RS,PF,Alpino	77-	281913		281002	
500	Alpino/S	77-	281913	281913	281002	281002
500	RS,PF,Alpino,Mont Juich	77-	281913		281002	
600	OR Atlas	86-		281913		281002
650	Ghost	96-		281913		281002
650	Ghost Legend	97-		281913		281002
650	Sport	92-		281913		281002
650	Strike	97-		281913		281002
650	VT TT Baja	86-		281913		281002
668	Ghost Strike/Diamante	98-		281913		281002
750	S/S Liquid/S Formula/Strike	98-		281913		281002
750	Super Sport	00-		281913		281002
800	TTS	99-		281920		281006
1000	SFC	04-		281920		281006

LINHAI						
Cyl. Cil.	Modèle Modello	Année Anno	Avant Ant.	Arrière Post.	Avant Ant.	Arrière Post.
160	Monarch	04-	281930K	281917A	281010A	
260	Main Street	04-	281930K	281917A	281010A	

LONCIN						
Cyl. Cil.	Modèle Modello	Année Anno	Avant Ant.	Arrière Post.	Avant Ant.	Arrière Post.
110	LX	02-	281919			
125	LX	02-	281919			
150	LX	02-	281930K		281010A	

MACBOR						
Cyl. Cil.	Modèle Modello	Année Anno	Avant Ant.	Arrière Post.	Avant Ant.	Arrière Post.
50	565	04-		281911		281000A
50	Racing 510	04-		281911		281000A
50	Racing 512	04-		281911		281000A
50	Racing 515	04-		281911		281000A

MAICO						
Cyl. Cil.	Modèle Modello	Année Anno	Avant Ant.	Arrière Post.	Avant Ant.	Arrière Post.
250	GM LC	85-	281913		281002	
250	GM Star	86-	281930F	281930F	281014	281014
250	GP E	87-	281930F	281930F	281014	281014
250	GP Motocross/E	87-	281930F	281930F	281014	281014
250	MD	83-	281913	281913	281002	281002
400	GP Motocross/E	87-	281930F	281930F	281014	281014
500	GM	85-	281913		281002	
500	GM LC	85-	281913		281002	
500	GM Star	86-	281930F	281930F	281014	281014
500	GP Motocross/E	87-	281930F	281930F	281014	281014
500	MX/Enduro	99	281917		281004	
550	GP	87-	281930F	281930F	281014	281014

MALAGUTI						
Cyl. Cil.	Modèle Modello	Année Anno	Avant Ant.	Arrière Post.	Avant Ant.	Arrière Post.
50	Centro	93-	281921		281007	
50	CIAK	99-	281910	281916	281000	
50	Ciak Master	04-06	281910		281000	
50	Ciak Mono	03-	281910		281000	
50	Ciak Twin Disk	02-	281910	281910	281000	281000
50	Drakon	05-	281920		281006	
50	Drakon	04-		281911		281000A
50	Dune ES	89-	281915			
50	El Crosser	95-	281910		281000	
50	F-10 Jet-line	94-	281910		281000	
50	F-10 KAT	99-00	281910		281000	
50	F-10 Time machine	03-	281910		281000	

* Adaptable
* Adattabile

Les références du constructeur sont seulement indicatives et n'impliquent pas que les pièces de rechange viennent du constructeur.
I codici di riferimento originali sono indicativi e non implicano che i ricambi provengano necessariamente dalla stessa fabbrica del costruttore.

FREINAGE FRENI PLAQUETTES DE FREIN PASTIGLIE FRENO

Cyl. Cil.	Modèle Modello	Année Anno	TNT / RB Original		SKY SARHANY	
			Avant Ant.	Arrière Post.	Avant Ant.	Arrière Post.
50	F-10 WAP	02-	281910		281000	
50	F-12 Aria Restyling	06-	281910		281000	
50	F-12 Phantom	99-	281910		281000	
50	F-12 Phantom	94-98	281921		281007	
50	F-12 Phantom Aria/Acqua	94-97	281921		281007	
50	F-12 Phantom Digit	02-	281910	281910	281000	281000
50	F-12 Phantom LC	99-	281910	281910	281000	281000
50	F-12 Phantom LC	94-98	281921		281007	
50	F-12 Phantom Restyling	01-04	281910		281000	
50	F-12 Racing life/tyre track	03-	281910	281910	281000	281000
50	F-15 Fire fox	00-	281910		281000	
50	F-15 Fire Fox	96-97	281921		281007	
50	F-15 Fire fox Air Cooled	05-06	281910		281000	
50	F-15 Fire fox LC	00-	281910	281910	281000	281000
50	F-15 Fire Fox LC	96-98	281921		281007	
50	F-15 Fire Fox LC	98-	281921		281007	
50	Fifty	04-	281947	281911		281000A
50	Fifty Evolution	91-	281911		281000A	
50	NKD Dragon	04-	281947	281911		281000A
50	XSM	04-	281947	281911		281000A
50	XTM	04-	281911	281911	281000A	281000A
50	Yesterday	97-	281910		281000	
50	Yesterday Euro	97-00	281910		281000	
80	Dune	93-	281930A		281009A	
80	F-10	92-	281910		281000	
100	Ciak	00-	281910	281910	281000	281000
100	F-12 Phantom	00-	281910		281000	
100	F-12 Phantom Twin disk	00-	281910	281910	281000	281000
125	Ciak	03-	281910		281000	
125	Ciak/Ciak Master	02-	281910		281000	
125	F-18 Warrior	00-03	281910		281000	
125	Madison	99-05	281947			
125	Madison 3	07-	281947	281920		281006
125	Madison R	06-	281947			
125	Phantom max	04-	281947			
125	Runner	87-	281930A		281009A	
125	Runner Rally	93-	281947			
150	Ciak	03-	281910	281910	281000	281000
150	Ciak/Ciak Master	02-	281910		281000	
150	F-18 Warrior	00-03	281910		281000	
150	Madison	99-	281947			
180	Madison	02-	281947			
200	Madison	04-	281917	281920	281004	281006
200	Madison	03-	281947			
200	Phantom max	04-	281947			
250	Madison	99-05	281930N			
250	Madison 3	07-	281947	281920		281006
250	Madison RS	06-	281930N			
250	Password	05-06	281947			
250	Password	07-	281947			
250	Phantom max	05-	281947			
250	RS Madison	06-	281947			
250	SM	97-	281917		281004	
400	Madison	01-05	281930N			
400	Madison K	06-	281930N			
500	Spidermax GT	04-	281947			

MALANCA						
80	E2C	82-	281913		281002	
125	E2 CS/5N/6N	82-	281913		281002	
125	GTI	83-	281913		281002	
125	Sport	83-	281913		281002	

MASAI ATV						
300	A QUAD	05-	281948		281018	
450	A QUAD	05-	281948		281018	

MBK						
50	Booster Next Generation	99-	281910		281000	
50	Booster Road	94-95	281910		281000	
50	Booster Rocket	96-	281910		281000	
50	Booster Spirit	96-	281910		281000	
50	Booster Track	96-	281910		281000	
50	Booster-R	94-	281910		281000	
50	Equalis	95-	281910		281000	
50	Evolis	92-	281910		281000	
50	Fizz	94-	281910		281000	
50	Flipper	98-	281910		281000	
50	Mach G	03-	281910		281000	
50	Nitro	97-	281910	281912	281000	281001

Cyl. Cil.	Modèle Modello	Année Anno	TNT / RB Original		SKY SARHANY	
			Avant Ant.	Arrière Post.	Avant Ant.	Arrière Post.
50	Ovetto	97-	281910		281000	
50	Stunt	99-	281912		281001	
50	Target	92-	281949		281019	
50	X-Limit	04-	281947	281911		281000A
50	X-Limit	98-03	281921		281007	
50	X-Power	04-	281947	281911		281000A
50	X-Power	99-03	281919	281918		281005
80	Evolis	94-	281910		281000	
100	Booster	99	281910		281000	
100	Booster	00-	281949		281019	
100	Nitro	01-	281910		281000	
100	Ovetto	01-	281910		281000	
125	Doodo	01-	281910		281000	
125	Flame R / F	96-03	281918		281005	
125	Flame X	04-	281922		281008	
125	Sky Cruiser	06-		281920		281006
125	Skyliner	98-02	281917		281004	
125	Skyliner	02-		281920		281006
125	Thunder	01-	281917	281920	281004	281006
150	Doodo	01-	281910		281000	
150	Skyliner	02-	281917	281920	281004	281006
150	Thunder	02-	281917	281920	281004	281006
150	Vertex	97-	281918		281005	
180	Skyliner	04-	281917	281920	281004	281006
250	Skyliner	01-	281930K		281010A	
250	Skyliner	00-03		281917A		
300	Kilibre	03-	281917	281917	281004	281004
400	Skyliner	04	281930K	281930L	281010A	281010B

MECATECNO						
50	Alevin	94-	281911		281000A	
50	Dragonfly	87-	281911	281911	281000A	281000A
50	Racing CR-7	93-	281911		281000A	
50	Racing CR-8	93-	281911		281000A	
50	Skywalker	89-	281911	281911	281000A	281000A
75	CR	91-	281911		281000A	

MERLIN						
125	DG-7	87-	281911	281911	281000A	281000A
350	DG Cresta	87-	281911	281911	281000A	281000A
350	DG Fius	87-	281911	281911	281000A	281000A
400	Nomada 4T	87-	281913		281002	

METRAKIT						
50	Fun 2T	05-		281911		281000A
50	Fun 4T	05-		281911		281000A
50	Mini GP	03-		281911		281000A
50	Mini GP XL	05-	281920		281006	

MH						
50	RX Racing	99-	281922		281008	
50	RYZ SM	99-	281922		281008	
50	Urban Bike	04-	281922		281008	
125	Arena Enduro	05-	281911	281911	281000A	281000A
125	Arena Motard	05-		281911		281000A

MINELLI						
125	Omega	06-	281930K	281917A	281010A	
250	Omega	06-	281930K	281917A	281010A	

MONDIAL						
1000	Evo	04-		281920		281006
1000	Piega	03-		281920		281006
1000	RZ Nuda	04-		281920		281006
1000	RZ Starfighter	04-		281920		281006

MONKEY BIKE						
50	MB D	06-	281949		281019	
50	MB G	06-	281949		281019	
50	MB R	06-	281949		281019	
90	MB R	06-	281949		281019	
110	MB D	06-	281949		281019	
110	MB G	06-	281949		281019	
110	MB M	06-	281949		281019	
125	MB SM	06-	281947	281911		281000A
125	MB TR	06-	281947	281911		281000A
200	MB SM	06-	281947	281911		281000A
200	MB TR	06-	281947	281911		281000A

FREINAGE FRENI PLAQUETTES DE FREIN PASTIGLIE FRENO

Cyl. Cil.	Modèle Modello	Année Anno	TNT / RD Original		SKY SARKANY	
			Avant Ant.	Arrière Post.	Avant Ant.	Arrière Post.
MONTESA						
80	Cross	96-	281917		281004	
80	Junior	96-	281948		281018	
125	Cota	88-	281911	281911	281000A	281000A
250	E	95-	281917		281004	
260	Evasion	92	281911	281911	281000A	281000A
260	Evasion	92-93		281913		281002
304	Cota	88-	281911	281911	281000A	281000A
307	Cota	89-	281911	281911	281000A	281000A
307	Cota Trial	88-	281911	281911	281000A	281000A
309	Cota	89-	281911	281913	281000A	281002
310	Cota	89-	281911		281000A	
310	Cota	90-		281913		281002
311	Cota	92-		281913		281002
311	Cota Trial	92-	281911		281000A	
314	Cota C	95-	281911	281911	281000A	281000A
314	Cota R	94-		281913		281002
315	Cota R	97-	281911	281911	281000A	281000A
320	Cota	96-	281917		281004	
330	Cota	87-	281911	281911	281000A	281000A
335	Cota	87-91	281911	281911	281000A	281000A
335	Cota Trial Excursion	89-	281911	281911	281000A	281000A
360	Enduro H7	87-	281913		281002	
360	Enduro M7	85-	281911		281000A	

Cyl. Cil.	Modèle Modello	Année Anno	TNT / RD Original		SKY SARKANY	
			Avant Ant.	Arrière Post.	Avant Ant.	Arrière Post.
MORINI						
250	Country XE	88-	281913		281002	
350	Dart	88-		281913		281002
350	Excalibur	87-	281930A		281009A	
350	Kanguro	88-	281930A	281913	281009A	281002
350	New York	88-		281913		281002
400	Dart	89-		281913		281002
400	S	95-	281913	281913	281002	281002
501	Camel	88-	281930A	281913	281009A	281002
501	Coguardo	88-		281913		281002
501	Excalibur	88-		281913		281002
501	Excalibur	87-	281930A		281009A	
501	New York	88-	281913	281913	281002	281002
501	New York	89-		281913		281002
501	XE	88-		281913		281002
950	O	05-		281920		281006
1200	Corsaro	05-		281920		281006
1200	Corsaro Avio	08-		281920		281006
1200	Granpasso	08-		281917		281004
1200	MM3	07-		281920		281006

Cyl. Cil.	Modèle Modello	Année Anno	TNT / RD Original		SKY SARKANY	
			Avant Ant.	Arrière Post.	Avant Ant.	Arrière Post.
MOTO GUZZI						
125	BX	92-	281913		281002	
125	C	92-	281913		281002	
125	Custom	85	281913		281002	
125	Enduro TT	85	281913		281002	
125	TTC	85-	281913		281002	
240	4	77-	281913		281002	
250	4	77-	281913		281002	
250	TS	75-76	281913		281002	
350		77-	281913		281002	
350	Falco	88-	281913		281002	
350	GTS	77-	281913		281002	
350	Imola	78-	281913		281002	
350	Nevada	92-	281913		281002	
350	NTX	88-	281913		281002	
350	NTX	90-	281913		281002	
350	V35 C			281913		281002
350	V35 Florida			281913		281002
350	V35 GT	92-	281913		281002	
350	V35 GT	90-		281913		281002
350	V35 I/Imola/Imola II	77	281913		281002	
400	GTS	79-	281913		281002	
500	Monza	77-	281913		281002	
500	V 50 1/2/3/Monza Chopper		281913		281002	
500	V50 Polizia Militaire	80-	281913		281002	
650	GT Sessantacinque	89-	281913		281002	
650	NTX	90-	281913		281002	
650	V65 Baja	86-	281913		281002	
650	V65 C	85-	281913		281002	
650	V65 GT	89-	281913		281002	
650	V65 Lario	86-	281913		281002	
650	V65 NTX	87-	281913		281002	
650	V65 SP/Chopper/Florida	81-	281913		281002	
650	V65 TT	86-	281913		281002	

Cyl. Cil.	Modèle Modello	Année Anno	TNT / RD Original		SKY SARKANY	
			Avant Ant.	Arrière Post.	Avant Ant.	Arrière Post.
750	Breva	03-		281920		281006
750	Duna	86-	281913		281002	
750	Nevada Classic I,E	06-		281920		281006
750	Nevada Club/Base	97-02	281913		281002	
750	Nevada/ Nevada Club	03-		281920		281006
750	NTX/SP/Nevada	90-	281913	281913	281002	281002
750	STR VIE	03-		281920		281006
750	Strada	94-	281913	281913	281002	281002
750	Targa	89-	281913	281913	281002	281002
750	V7 Classic	08-		281913		281002
750	V7 Ippogrifo	97-		281913		281002
750	V75	76-	281913		281002	
850	Breva	06-		281920		281006
850	Griso	06-		281920		281006
940	Custom	07-		281917		281004
1000	California Special Sport	03-		281917		281004
1000	California Stone	03-		281917		281004
1000	Centaurio	96-		281913		281002
1000	Daytona RS	97-		281913		281002
1000	Daytona/SP/DrJohn	91-97		281913		281002
1000	EV Stone	02-		281920		281006
1000	GT	92-		281913		281002
1000	V10 Centaurio/GT	96-		281913		281002
1000	V-11 Sport Ballabio	03-		281920		281006
1100	Breva	04-		281920		281006
1100	California EV	97-		281917		281004
1100	California EV Touring	01-05		281913		281002
1100	California Jackal	99-		281917		281004
1100	California Special	99-		281917		281004
1100	Griso	05-		281920		281006
1100	Quota ES	99-	281917	281917	281004	281004
1100	Sport	95-97		281913		281002
1100	STR	04-		281920		281006
1100	V-10 Centaurio Sport	99-		281913		281002
1100	V-11 Le Mans	99-		281913		281002
1100	V-11 Le Mans Rosso Corsa	03-		281913		281002
1100	V-11 Scura	02-		281913		281002
1100	V-11 Scura Sport	02-		281913		281002
1100	V-11 Sport	99-		281913		281002
1150	Stelvio	08-		281917		281004
1200	Norge	06-		281917		281004
1200	Sport	07-		281917		281004

Cyl. Cil.	Modèle Modello	Année Anno	TNT / RD Original		SKY SARKANY	
			Avant Ant.	Arrière Post.	Avant Ant.	Arrière Post.
MOTOR HISPANIA						
50	Furia	96-	281911	281911	281000A	281000A
50	Furia Super Motard	96-	281911	281911	281000A	281000A
50	Trail Laser	93-	281911		281000A	
50	Urbain Bike	04-		281911		281000A
50	XR G-30	93-	281911		281000A	
125	Arena Motard	05-	281922		281008	
RX	Racing	99-		281911		281000A
RYZ	Enduro	99-	281911	281911	281000A	281000A
RYZ	SM	99-		281911		281000A

Cyl. Cil.	Modèle Modello	Année Anno	TNT / RD Original		SKY SARKANY	
			Avant Ant.	Arrière Post.	Avant Ant.	Arrière Post.
MOTRON						
50	XLE	94-	281921		281007	
	MZ					
50	Moskito	00-	281948		281018	
660	Baghira	00-	281930A		281009A	
660	Mastiff	00-	281930A		281009A	
660	Skorpion Cup	99-		281913		281002
660	Skorpion Tour/Sport/Replica	94-		281913		281002
660	Skorpion Traveller	96-		281913		281002
1000	S	01-02		281920		281006

Cyl. Cil.	Modèle Modello	Année Anno	TNT / RD Original		SKY SARKANY	
			Avant Ant.	Arrière Post.	Avant Ant.	Arrière Post.
NORTON						
952	Comando	04-		281920		281006

Cyl. Cil.	Modèle Modello	Année Anno	TNT / RD Original		SKY SARKANY	
			Avant Ant.	Arrière Post.	Avant Ant.	Arrière Post.
PEUGEOT						
50	Buxy (AJP Cal)	94-	281911		281000A	
50	Buxy (Brembo cal)	94-97	281910		281000	
50	Buxy (Hengtong cal)	94-	281948		281018	
50	Elistar advantage 2	05-	281911	281921A	281000A	
50	Elistar TSDI	02-		281921A		
50	Elyséo	02-	281911	281911	281000A	281000A
50	Elyséo (AJP Cal)	98-01	281911		281000A	
50	Elyseo (Hengtong cal)	98-	281948		281018	
50	Elystar	03-	281911	281921A	281000A	
50	Fox	95-	281911		281000A	

* Adaptable
* Adattabile

Les références du constructeur sont seulement indicatives et n'impliquent pas que les pièces de rechange viennent du constructeur.
I codici di riferimento originali sono indicativi e non implicano che i ricambi provengano necessariamente dalla stessa fabbrica del costruttore.

FREINAGE FRENI PLAQUETTES DE FREIN PASTIGLIE FRENO

Cyl. Cil.	Modèle Modello	Année Anno	TNT / RÖ Original		SKY SARKANY	
			Avant Ant.	Arrière Post.	Avant Ant.	Arrière Post.
50	Jet force	03-	281911	281911	281000A	281000A
50	Looxor	02-	281911		281000A	
50	Ludix	04-	281911		281000A	
50	Metal-x	03-	281911		281000A	
50	New Vivacity	08-	281930G		281015	
50	Speedake (AJP Cal)	94-	281911		281000A	
50	Speedake (Bembo cal)	94-97	281910		281000	
50	Speedake (Hengtong cal)	94-	281948		281018	
50	Speedfight	96-	281948		281018	
50	Speedfight 2	00-	281948		281018	
50	Speedfight 2 Furious/WRC	03-	281911	281911	281000A	281000A
50	Speedfight 2 LC	01-	281911	281911	281000A	281000A
50	Speedfight A/C	01-	281911		281000A	
50	Speedfight LC	97-	281911	281911	281000A	281000A
50	Speedfight LC	95-	281911		281000A	
50	Speedfight LC	00-	281911		281000A	
50	Speedfight LC (AJP Cal)	96-	281911		281000A	
50	Speedfight LC (Hengtong cal)	96-	281948		281018	
50	Speedfight LC (Brembo cal)	96-	281910		281000	
50	Squab (Hengtong cal)	96-	281948		281018	
50	SV Geo Exécutive	95-	281930G		281015	
50	TKR Street Zone/WRC	03-	281911		281000A	
50	TKR/TKR WRC	05-	281911		281000A	
50	Trekker off road	97-	281948		281018	
50	V Clic	08-	281949		281019	
50	Vivacity (AJP Cal)	99-	281911		281000A	
50	Vivacity (Hengtong cal)	05-	281948		281018	
50	XP6 Enduro	98-03	281911	281911	281000A	281000A
50	XP6 SM	05-	281911	281911	281000A	281000A
50	XP6 Street	04-	281947	281911		
50	XP6 Supermotard	06-	281911	281911	281000A	281000A
50	XP6 Top Road	06-	281911	281911	281000A	281000A
50	XP6 Trail	04-	281911	281911	281000A	281000A
50	XPLD AV	90-	281921		281007	
50	XPS 6 Street / Super Motard	04-	281947	281911		281000A
50	XPS Enduro	04-	281911	281911	281000A	281000A
50	XPS SM	05-	281947	281911		281000A
50	XPS Street	05-	281947			
50	XPS Super Motard	04-		281911		281000A
50	XPS Super Motard	06-07	281947			
50	XR 6	05-	281922	281911	281008	281000A
50	XR 7	08-		281911		281000A
50	XR-6/ Race Spec	02-	281922	281911	281008	281000A
50	X-Race	01-	281911	281911	281000A	281000A
50	Zenith (Grimeca Cal)	96-	281910		281000	
50	Zenith (Hengtong cal)	96-	281948		281018	
50	Zenith LM	95-	281911		281000A	
50	Zenith LN / LS	97-	281911		281000A	
50	Zenith Luxe	94-	281910		281000	
80	Speedfight	96-	281948		281018	
80	SV	96-	281930G		281015	
100	Elyséo	01-	281911	281911	281000A	281000A
100	Elyséo (AJP Cal)	98-01	281911		281000A	
100	Looxor	03-	281911	281911	281000A	281000A
100	Speedfight (AJP Cal)	97-	281911	281911	281000A	281000A
100	Speedfight (Hengtong cal)	97-	281948		281018	
100	Speedfight 2 Furious/WRC	03-	281911	281911	281000A	281000A
100	Speedfight LCA(Brembo cal)	97-	281910		281000	
100	Squab	98-	281911	281911	281000A	281000A
100	Trekker Road	98-	281911		281000A	
100	Vivacity (AJP Cal)	99-	281911		281000A	
100	Vivacity (Hengtong cal)	05-	281948		281018	
125	Elistar EFI	02-		281921A		
125	Elyseo	00-	281947			
125	Elyséo (AJP Cal)	98-	281911		281000A	
125	Elystar	03-	281947	281921A		
125	Geopolis	06-	281947	281921A		
125	Jet force / Compressor	03-	281947	281921A		
125	Looxor	01-02	281911	281911	281000A	281000A
125	Looxor	03-04		281911		281000A
125	Looxor	05-		281921A		
125	Ludix	05-	281911		281000A	
125	Satelis	04-	281911		281000A	
125	Satelis K15	06-	281947	281911		281000A
125	Satelis K15	07-		281921A		
125	Satelis K15 Compressor	06-	281947	281911		281000A
125	Satelis K15 Compressor	07-		281921A		
125	XPS CT	06-		281911		281000A
150	Elyseo	01-		281921A		
150	Elyseo	00-	281947			

Cyl. Cil.	Modèle Modello	Année Anno	TNT / RÖ Original		SKY SARKANY	
			Avant Ant.	Arrière Post.	Avant Ant.	Arrière Post.
150	Elyséo	01-		281911		281000A
150	Elystar	03-	281947	281921A		
150	Looxor	03-		281911		281000A
150	Looxor	02-	281911	281911	281000A	281000A
250	Geopolis	06-	281930H	281930H	281006B	281006B
250	Geopolis Premium	06-	281930H	281930H	281006B	281006B
250	Satelis	06-	281947	281921A		
250	Satelis ABS	06-	281930H	281930H	281006B	281006B
250	Satelis City	06-	281920	281916	281006	
500	Satelis	06-	281920	281920	281006	281006

PGO						
Cyl. Cil.	Modèle Modello	Année Anno	Avant Ant.	Arrière Post.	Avant Ant.	Arrière Post.
50	Big max	95-	281949		281019	
50	Big max Sport	96-	281949		281019	
50	Big max	03-	281948		281018	
50	Comet	93-	281949		281019	
50	Comet sport	91-	281949		281019	
50	DR Big	01-	281949		281019	
50	EPS	96-	281949		281019	
50	Galaxy	93-	281948		281018	
50	Hot	97-	281949		281019	
50	Mega	97-	281949		281019	
50	Mega Fifty	99-	281948		281018	
50	PMS	99-	282052Z		281020	
50	PMX	99-	281949		281019	
50	PMX Sport	01-	282052Z		281020	
50	PS	93-	281948		281018	
50	Road 66	95-	281948		281018	
50	Star	95-	281948		281018	
50	Tornado	97-	281949		281019	
50	T-Rex	99-	282052Z		281020	
50	T-Rex 3	02-	281930C		281011	
50	X-Rider	03-		281948		281018
80	Big max	95-	281949		281019	
80	STAR	95-	281948		281018	
90	Big max	95-	281949		281019	
90	Tornado	00-	281949		281019	
100	Big max	94-	281949		281019	
100	My Bubu	02-	282052Z		281020	
110	PMS	99-	282052Z		281020	
110	PMX	00-	281949		281019	
110	T-Rex	99-	282052Z		281020	
125	Ligero	06-	282052Z		281020	
125	Charge A/B	02-	282052Z		281020	
125	G-Max	05-		281919		
125	Kung fu		281949		281019	
125	My Bubu/Young Bubu	02-	282052Z		281020	
125	Star	95-	281919	281913		281002
125	Tornado	96-	281949		281019	
125	T-Rex	99-	282052Z		281020	
125	X-Rider	03-		281948		281018
150	G-Max	05-		281919		
150	TR3	02-	282052Z		281020	
150	T-Rex	01-	282052Z		281020	
150	X-Rider	03-		281948		281018
250	G-Max	06-		281919		

PIAGGIO						
Cyl. Cil.	Modèle Modello	Année Anno	Avant Ant.	Arrière Post.	Avant Ant.	Arrière Post.
50	Diesis	01	281949		281019	
50	FLY 2T/4T	05-	281930H		281006B	
50	Free	96-	281910		281000	
50	Liberty	97-99	281916			
50	Liberty 2T Grimeca Caliper	06-08	281916			
50	Liberty 2T RST	02-05	281916			
50	Liberty 4T	00-	281916			
50	Liberty 4T RST	04-06	281916			
50	Liberty 4T Sport Grimeca Caliper	06-08	281916			
50	Liberty PTT EU2	04-05	281916			
50	NGR MC3 Grimeca Caliper	01-04		281916		
50	NGR	94-98	281910		281000	
50	NRG Extreme	99-	281910		281000	
50	NRG Extreme	01-		281916		
50	NRG MC2	96-97	281910		281000	
50	NRG MC2	98-03	281910	281916	281000	
50	NRG MC3	01-04	281910	281910	281000	281000
50	NRG Power DD	05-	281910	281910	281000	281000
50	NRG Purejet	05-	281910	281910	281000	281000
50	NTT	95-	281910		281000	
50	Quartz	92-	281910		281000	
50	Storm	94-95	281910		281000	

FREINAGE FRENI PLAQUETTES DE FREIN PASTIGLIE FRENO

Cyl. Cil.	Modèle Modello	Année Anno	TNT / RÖ Original		SKY SARKANY	
			Avant Ant.	Arrière Post.	Avant Ant.	Arrière Post.
50	Typhoon	93-98	281910		281000	
50	Typhoon Catalysed	02-	281910	281910	281000	281000
50	Typhoon-x	99-	281910		281000	
50	Vespa ET2	97-05	281916			
50	Vespa ET4	00-05	281916			
50	Vespa LX 2T/4T Grimeca Caliper	05-08	281916			
50	Vespa LXV 2T Grimeca Caliper	06-08	281916			
50	Vespa S 2T Grimeca Caliper	07-08	281916			
50	ZIP 4T	00-	281916			
50	ZIP CAT	00-	281916			
50	ZIP Disco / SP	96-	281916			
50	Zip Fast Rider	93-95	281910		281000	
50	ZIP Fast Rider / Zip RST	96-	281916			
50	Zip II	01-	281910	281916	281000	
50	ZIP SP Euro 2 Grimeca Caliper	06-08	281916			
50	Zip SP LC Grimeca Caliper	96-00	281916			
80	Typhoon	95-	281910		281000	
100	Diesis	01	281949		281019	
100	Fly 4T	06-07	281930H		281006B	
100	Free	02-	281910		281000	
100	ZIP	06-08	281916			
125	Beverly RST(Heng Tong)	01-07	281930H	281930H	281006B	281006B
125	Beverly Eu3 Mic Sport	07	281930H	281930H	281006B	281006B
125	Beverly Tourer Eu3	08	281930H	281930H	281006B	281006B
125	Beverly 4T	02-	281947	281947		
125	Carnaby	07-08	281930H	281930H	281006B	281006B
125	Fly Eu3	07-08	281930H		281006B	
125	Fly	05-07	281930H		281006B	
125	GT L	04-	281930H		281006B	
125	Hexagon	94-95	281910		281000	
125	Hexagon GTX	00-	281930H		281006B	
125	Hexagon GTX	00	281947			
125	Hexagon LX	98-99	281930H		281006B	
125	Hexagon LX	98-99	281947			
125	Hexagon LX4	99-	281930H		281006B	
125	Hexagon LX4	98-99	281947			
125	Liberty	98-	281916			
125	Liberty 4T	98-	281916			
125	Liberty 4T Euro 3 Grimeca Caliper	07-08	281916			
125	Liberty 4T Grimeca Caliper	06-07	281916			
125	Liberty 4T Sport	06-08	281916			
125	Liberty 4T Sport Grimeca Caliper	06-	281916			
125	Liberty Grimeca Caliper	01-02	281916			
125	Liberty RST PTT	05-06	281916			
125	LXV 4T Grimeca Caliper	06-07	281916			
125	MP 3	07-	281916	281920A		
125	PX	02-	281916			
125	Sfera 4T	96-	281916			
125	Skipper LX	98-99	281930H		281006B	
125	Skipper LX	98-99	281947			
125	SKR ST 4T	00-	281930H		281006B	
125	SKR ST 4T	00-	281947			
125	Super Hexagon (hengtong) 11'	00-	281930H		281006B	
125	Super Hexagon (hengtong) 12'	01-	281930H		281006B	
125	Super Hexagon GTX	01-	281947			
125	Super Hexagon GTX 11'	00-	281947			
125	Super Hexagon GTX 12'	01	281930H		281006B	
125	Typhoon Catalysed	02-	281910	281910	281000	281000
125	Vespa ET 4	99-02	281916			
125	Vespa GT(Heng Tong)	03-	281930H		281006B	
125	Vespa GT	03-	281947			
125	Vespa GT Eu3	06-07	281930H		281006B	
125	Vespa GTV	06-	281930H		281006B	
125	Vespa LX	05-06	281916			
125	Vespa LX Grimeca Caliper	06-07	281916			
125	Vespa LXV 4T	06-07	281916			
125	Vespa LXV 4T Navy	08-	281916			
125	Vespa S 4T Euro 3	07-08	281916			
125	X Evo	08-	281930H	281920A	281006B	
125	X7	07-	281930H	281930I	281006B	281006C
125	X8	04-	281930H	281920A	281006B	
125	X9/X9 Evolution	01-03	281920	281920	281006	281006
125	X9 Evolution Gauche	05-07	281930H	281920	281006B	281006
125	X9 Evolution Droit	05-07	281930I	281920	281006C	281006
125	ZIP	00-02	281916			
125	ZIP 2 4T	00-	281916			
150	Fly	05-	281930H		281006B	
150	Heragon GTX	00-	281930H		281006B	
150	Hexagon	94-95	281910		281000	
150	Hexagon GTX	00-	281947			

Cyl. Cil.	Modèle Modello	Année Anno	TNT / RÖ Original		SKY SARKANY	
			Avant Ant.	Arrière Post.	Avant Ant.	Arrière Post.
150	Liberty	00-02	281916			
150	Liberty 4T	00-	281916			
150	Liberty 4-T Sport Euro 3	08-	281916			
150	Liberty Grimeca Caliper	01-02	281916			
150	PX	02-	281916			
150	Skipper LX	98-99	281930H		281006B	
150	Skipper LX	98-99	281947			
150	SKR ST 4T	00-	281930H		281006B	
150	SKR ST 4T	00-	281947			
150	Vespa ET4	02-	281916			
150	Vespa ET4	99-02	281916			
150	Vespa LX Grimeca Caliper	05-06	281916			
150	Vespa LX Grimeca Caliper	06-07	281916			
150	X8 Street Eu2	06-08	281930H		281006B	
180	Hexagon GTX	00	281930H		281006B	
180	Hexagon GTX	00	281947			
180	Hexagon LX	98-99	281947			
180	Hexagon LXT	98-99	281930H		281006B	
180	Hexagon LXT	98-99	281947			
180	Super Hexagon (hengtong) 11'	00-	281930H		281006B	
180	Super Hexagon (hengtong) GTX 12'	01-	281930H		281006B	
180	Super Hexagon GTX	00-	281947			
180	X9	02-04	281920	281920	281006	281006
180	X9 Amalfi	01-	281920	281920	281006	281006
200	Beverly 5Heng Tong)	02-	281930H	281930H	281006B	281006B
200	Beverly 4T	02-	281947	281947		
200	Carnaby	07-08	281930H	281930H	281006B	281006B
200	GT L	04-	281930H		281006B	
200	Liberty	04-	281916			
200	Liberty 4T Sport	06-	281916			
200	Liberty RST	04-	281916			
200	LXT	98-	281947			
200	Vespa GT	03-07	281930H		281006B	
200	X8	04-	281930H	281920	281006B	281006
200	X8	05-	281930H	281920A	281006B	
200	X9/X9 Evolution	02-03	281920	281920	281006	281006
250	Beverly/Beverly Cruiser	04-07	281930H	281930H	281006B	281006B
250	Beverly Eu3 Mic/re Eu3/Sport	06-07	281930H	281930H	281006B	281006B
250	Beverly Rst/Tourer Eu3	03-08	281930H	281930H	281006B	281006B
250	GTX Super Hexagon 12'	01-	281947			
250	Hexagon GT 4-T	98-99	281930H		281006B	
250	Hexagon GT 4-T	98-99	281947			
250	Hexagon GTX	00-	281930H		281006B	
250	Hexagon GTX	00-	281947			
250	Hexagon LX4	98-99	281947			
250	MP 3	06-07	281916	281920A		
250	Vespa GTE	05-	281930H	281920A	281006B	
250	X Evo	08-	281930H	281920A	281006B	
250	X7	08-	281930H	281930I	281006B	281006C
250	X8	05-	281930H	281920A	281006B	
250	X9	00	281920	281920	281006	281006
250	X9 Evolution Gauche	06	281930H	281920	281006B	281006
250	X9 Evolution Droite	06	281930I	281920	281006C	281006
400	Beverly I,E	06-	281917	281920	281004	281006
400	MP 3	07	281916	281930H		281006B
400	X Evo Droite	08-	281930I	281930H	281006C	281006B
400	X Evo Gauche	08-	281930H	281930H	281006B	281006B
400	X8 Gauche	07-08	281930H	281930H	281006B	281006B
400	X8 Droite	07-08	281930I	281930H	281006C	281006B
500	Beverly Eu3	06-08	281920		281006	
500	Beverly	02-04	281930H	281920	281006C	281006
500	X9	01-03	281920	281920	281006	281006
500	X9 ABS	03-07	281917	281920	281004	281006
500	X9 EVO	03-07	281917	281920	281004	281006

POLARIS						
200	Phoenix	05-		281948		281018

PRAGA						
250	Enduro	03-	281917		281004	
610	Enduro	03-	281917		281004	

PUCH						
50	Condor	85-	281911		281000A	
50	Monta Lujo	85-	281911		281000A	
50	TXZ	92-	281911		281000A	
75	Cobra	85-	281911		281000A	
80	Maxi	88-	281911		281000A	
80	MAXI	88-		281913		281002

* Adaptable
* Adattabile

Les références du constructeur sont seulement indicatives et n'impliquent pas que les pièces de rechange viennent du constructeur.
I codici di riferimento originali sono indicativi e non implicano che i ricambi provengano necessariamente dalla stessa fabbrica del costruttore.

AS 277

FREINAGE FRENI PLAQUETTES DE FREIN PASTIGLIE FRENO

Cyl. Cil.	Modèle Modello	Année Anno	TNT / RPD Original		SKY SARKANY	
			Avant Ant.	Arrière Post.	Avant Ant.	Arrière Post.

RENAULT						
50	Campus	02-	281910		281000	
125	Fulltime	02-	281910	281916	281000	
125	Kouranos	02-	281910	281916	281000	
150	Fulltime	02-	281910	281916	281000	
250	Kouranos	02-	281910	281916	281000	

RIEJU						
50	DRAC AIR/DL	94-	281911		281000A	
50	FD4 Super Marathon	85-	281911		281000A	
50	First H2O	97-	281911		281000A	
50	MRX	02-	281911	281911	281000A	281000A
50	MRX	03-	281947	281911		281000A
50	MRX PRO	05-	281922	281911	281008	281000A
50	MRX PRO	08-	281920	281911	281006	281000A
50	RD DL	94-95	281911		281000A	
50	RR / SM	96-	281911	281911	281000A	281000A
50	RR Castrol	99-	281922	281911	281008	281000A
50	RR GV	96-98	281911	281911	281000A	281000A
50	RR Spike	99-	281911	281911	281000A	281000A
50	RR Sport	05-	281911	281911	281000A	281000A
50	RS1	92-95	281911		281000A	
50	RS1	89-	281911		281000A	
50	RS1 / Evolution	96-01	281911		281000A	
50	RS1 Agua	94-95	281911		281000A	
50	RS1 Castrol	01-	281947	281911		281000A
50	RS2	06-		281948		281018
50	RS2 Matrix	03-05		281921A		
50	RS2 NKD	04-06		281921A		
50	RV	87-	281911		281000A	
50	SMX	02-	281922	281911	281008	281000A
50	SMX (AJP Caliper)	02-	281911	281911	281000A	281000A
50	Spike	98-	281911	281911	281000A	281000A
50	Spike	02-	281922	281911	281008	281000A
50	Spike X	06-	281911	281911	281000A	281000A
50	Tango	07-	281920	281911	281006	281000A
50	Windy	94-	281911		281000A	
75	K6 / P6	87-	281911		281000A	
80	MR C/E	88-	281911		281000A	
80	MR Cross	87-	281911		281000A	
80	MR Enduro	87-	281911		281000A	
80	RST	91-	281911	281911	281000A	281000A
80	RST	90-		281911		281000A
125	MRX	03-	281922	281911	281008	281000A
125	NKD	06-		281921A		
125	RS2	06-		281948		281018
125	RS2 NKD	06-		281948		281018
125	SMX	03-	281922	281911	281008	281000A
125	SMX	08-		281911		281000A
125	Tango/Pro	06-		281911		281000A
125	Tango/Pro	06-		281920		281006
125	Tangoo	08-	281911		281000A	
250	Tangoo	08-		281911		281000A
250	Tangoo	08-		281920		281006

ROXON						
50	Duel SM	06-	281911	281911	281000A	281000A
50	Duel TT	06-	281911	281911	281000A	281000A
150	RX	04-		281948		281018
150	Sport Spirit	04-		281948		281018

SACHS						
50	Bee	08-	281918		281005	
50	ER 12°	08-	281918		281005	
50	Madass	05-	281922		281008	
50	Speed Force	08-	281930G		281015	
50	Speed Jet	08-	281930G		281015	
50	SX 1	08-	281930G		281015	
80	SW Lotus		281913		281002	
125	BEE	08-	281918		281005	
125	Madass	05-	281922		281008	
125	ZX	98-	281930A		281009A	
125	ZZ	98-	281930A		281009A	
650	Roadster	03-		281913		281002
800	Roadster	03-		281913		281002

SANGLAS						
400	Y	79-80	281913		281002	
500	S2	79-80	281913		281002	

Cyl. Cil.	Modèle Modello	Année Anno	TNT / RPD Original		SKY SARKANY	
			Avant Ant.	Arrière Post.	Avant Ant.	Arrière Post.

SCORPA						
125	TYS F	05-	281911		281000A	
175	TYS F	06-	281911		281000A	
250	2S5 Works	95-	281911	281911	281000A	281000A
250	Easy	96-99	281911	281911	281000A	281000A
280	Easy Race	99-	281911	281911	281000A	281000A

SHERCO						
50	Enduro / SM	02-	281922	281911	281008	281000A
50	SM Ipone Limited	05-		281911		281000A
125	City Corp	03-		281911		281000A
125	City Corp SM	03-	281922	281911	281008	281000A
125	Trial 1,25	99-01	281922	281911	281008	281000A
200	Trial 2,0	99-	281911	281911	281000A	281000A
250	Enduro 2,5i	06-	281917		281004	
250	Trial 2,5	99-01	281911	281911	281000A	281000A
290	Trial 2,9	99-01	281911	281911	281000A	281000A
450	4,5i Enduro	05-	281917		281004	
510	Enduro 5,1i	06-	281917		281004	
510	SM 5,1 4T	06-	281917		281004	

SIAMOTO						
50	Birdie	99-	281948		281018	
50	Birdie	02-	281949		281019	
50	Capri	99-	281911	281911	281000A	281000A
50	Falkon	99-	281911	281911	281000A	281000A
50	Mat	99-	281949		281019	
50	Scross	99-	281921		281007	
100	MAT	99-	281948		281018	
100	Top Racing	99-	281948		281018	
125	Capri	99-	281911	281911	281000A	281000A
125	Falkon	99-	281911	281911	281000A	281000A
180	Capri	99-	281911	281911	281000A	281000A

SIMSON						
80	IFA	89	281913		281002	
80	SR 2 CE	-	281913		281002	
83	S CX	-	281913		281002	
83	S OR	-	281913		281002	

SUMCO						
90	Junior Cross	06-	281911		281000A	
110	Dingo DG	06-	281948		281018	
125	Kira KR SM	06-	281947	281911		281000A
125	Kira KR TR	05-	281947	281911		281000A
125	MS	06-	281930K	281917A	281010A	
150	MS	06-	281930K	281917A	281010A	
200	Kira KR TR	05-	281947	281911		281000A

SUZUKI						
50	AE R / L	88-	281948		281018	
50	AH Address	95-	281910		281000	
50	AH Address	92-94	281948		281018	
50	AP	95-	281910		281000	
50	AY Katana DD	99-	281910	281911	281000	281000A
50	AY Katana W/ WR	97-	281910		281000	
50	CC Tune	92-	281948		281018	
50	Condor	89-	281911		281000A	
50	CP	85-	281948		281018	
50	CR DC	87-	281948		281018	
50	DR Big	89-	281911		281000A	
50	DR LC	94-	281911		281000A	
50	Estilete UF	00-	281910		281000	
50	GaG	88-	281948		281018	
50	R7 Address	96-	281910		281000	
50	RF	95-	281910		281000	
50	RMX	98-	281911	281911	281000A	281000A
50	SMX	98-	281911	281911	281000A	281000A
50	UF	99-	281911		281000A	
50	UX W Zillion	99-	281911		281000A	
50	ZZ Scooter	92-	281948		281018	
75	ZZ Zepia	92-	281948		281018	
75	LIDO Style	89-	281948		281018	
80	AH Address / V / Tune	92-	281948		281018	
80	AH Scooter	92-	281948		281018	
80	RM	86-95	281948	281948	281018	281018
80	RM	96-02		281948		281018
80	RM G/H/J/K	86-89	281948		281018	
80	RM L/M/N/P/R/S	90-95	281948	281948	281018	281018

FREINAGE FRENI PLAQUETTES DE FREIN PASTIGLIE FRENO

Cyl. Cil.	Modèle Modello	Année Anno	TNT / RÖ Original		SKY SARKANY	
			Avant Ant.	Arrière Post.	Avant Ant.	Arrière Post.
80	ZZ Sepia	90-	281948		281018	
85	RM	02-04		281948		281018
100	Address	95-	281910		281000	
100	AH Address / V	91-94	281948		281018	
125	AN Burgman	02	281917	281920	281004	281006
125	GN	99-	281948		281018	
125	GS S	99-	281948		281018	
125	LIDO Vario Scooter	90-	281948		281018	
125	RGV Water Cooled	98-	281919			
125	RM	85-86	281930F		281014	
125	Shogun R	05-	281919			
125	Sixteen	08-	281931			
125	UE	01-	281948		281018	
125	UH Burgman	02-06	281917		281004	
125	UH Burgman	03-		281920		281006
125	VL Intruder	00-	281930F		281014	
125	VZ Marauder	99-	281930F		281014	
150	FX 4 T	98-	281919	281919		
150	RG I,C,	98-	281919	281919		
150	Sixteen	08-	281931			
150	UE CT	02-	281948		281018	
150	UH Burgman	04-	281917	281920	281004	281006
200	UH Burgman	07-	281931			
250	Burgman	04-	281930J	281930C	281016	281011
250	Burgman	98-03	281930J	281930D	281016	281012
250	RM	86	281930F		281014	
250	RM G	86-	281930F		281014	
250	Sky Wave / Type S	03-		281930D		281012
250	TU X(Volty)	97-	281930F		281014	
250	VZ Marauder	00-	281930F		281014	
400	Burgman	01-	281930J	281930C	281016	281011
400	Burgman	99-00	281930J	281930D	281016	281012
400	LS Savage	87-	281930F		281014	
400	Sky Wave	03-		281930D		281012
450	GS L	88-	281930F		281014	
500	DR S	89-	281930F		281014	
500	RM	85-86	281930F		281014	
600	DR Djebel / Dakar	89-	281930F		281014	
600	DR Paris Dakar	87-89	281930F		281014	
600	DR R Djebel	86-88	281930F		281014	
600	DR RH	87-89	281930F		281014	
600	DR S Dakar	85-	281930F		281014	
600	DR SN	87-89	281930F		281014	
600	SP F	85-87	281930F		281014	
600	VS S Intruder	95-	281930F		281014	
650	Burgman	03-09				
650	DR Djebel	90	281930F		281014	
650	LS P Savage	87-	281930F		281014	
800	DR S Big	91-95		281919		
800	DR ST Big	96-		281919		

SUZUKI ATV						
300	LT-F King Quad (right)	02-	281919			
450	LT R	06-	281919			
500	LT R	88-	281948		281018	
500	LT-A FY Quadmaster (right)	00-	281919			
500	LT-F FW/FX/FY (right)	00-	281919			

SWM						
125	GP	86-	281913	281913	281002	281002
125	S1-S2		281913		281002	
250	Explorer	86	281913	281913	281002	281002
250	Pioner	86	281913	281913	281002	281002
250	S1-S2		281913		281002	
329	TRL MJ	86-	281913		281002	

SYM						
50	Jet	99-05	282052Z		281020	
50	Jet alpha	95-	282052Z		281020	
50	Jet euro X	05-	282052Z		281020	
50	Jet Sport X	06-	282052Z		281020	
50	Jungle	96-	282052Z		281020	
50	Mask / Mask LC	00-	282052Z		281020	
50	Mio	05-	282052Z		281020	
50	Red devil	97-	282052Z		281020	
50	Super Fancy	95-97	282052Z		281020	
100	Jet	00-	282052Z		281020	
100	Jet euro X	05-	282052Z		281020	
100	Jet Sport X SR	06-	282052Z		281020	
100	Mio	05-	282052Z		281020	

Cyl. Cil.	Modèle Modello	Année Anno	TNT / RÖ Original		SKY SARKANY	
			Avant Ant.	Arrière Post.	Avant Ant.	Arrière Post.
100	Super Fancy	95-97	282052Z		281020	
125	Attila	99-	282052Z		281020	
125	HD Evo	06-	282052Z	281917A	281020	
125	Megalo	02-	282052Z		281020	
125	New Duke	02-	282052Z		281020	
125	RS	05-		281919		
125	Super Duke	95-	282052Z		281020	
150	Attila	00-	282052Z		281020	
150	Ho1	95-	282052Z		281020	
150	RS	05-		281919		
150	Super Duke	96-	282052Z		281020	
200	H SE	06-	282052Z		281020	
250	GTS Joymax	05-07	281930J		281016	
250	Joymax i	07-	281919			
500	GT	05-	281930J		281016	

TGB						
50	101	05-	282052Z		281020	
50	303 R	99-	281948		281018	
50	409 F	00-05	281948		281018	
50	Akros	95-98	281948		281018	
50	Akros	99-	282052Z		281020	
50	Delivery	04-	282052Z		281020	
50	Ergon	94-	281948		281018	
50	Platform	06-	282052Z		281020	
50	Sunset	07-	281948		281018	
101	S	06-	281948		281018	
125	101	05-	282052Z		281020	
125	303 R	99-	281948		281018	
125	409 F	02-05	281948		281018	
125	Platform	06-	282052Z		281020	
150	101	05-	282052Z		281020	
150	409 F	02-05	281948		281018	
150	Platform	06-	282052Z		281020	
150	Sunset	07-	281948		281018	

TGB ATV						
250	Quad Blade	06-	281948	281948	281018	281018
400	Quad blade	06-	281948	281919	281018	

TM						
80	GS/MC	86-89		281913		281002
80	GS/MC	93-	281917		281004	
80	Junior	05-	281917		281004	
80	Junior	96-	281948		281018	
85	Junior	05-	281917		281004	
85	MX	01-04	281917		281004	
85	MX	05-	281917		281004	
100	Junior	05-	281917		281004	
125	EN	05-	281917		281004	
125	Enduro	00-04	281917		281004	
125	GS/MC	86-89		281913		281002
125	GS/MC	93-	281917		281004	
125	MX	00-04	281917		281004	
125	MX	05-	281917		281004	
250	EN	04-	281917		281004	
250	Enduro 4T	00-	281917		281004	
250	MX	05-	281917		281004	
300	Enduro	05-	281917		281004	
300	Enduro 4T	01-	281917		281004	
300	MX	05-	281917		281004	
400	Cross 4T	00-02	281917		281004	
400	Cross 4T	03-	281917		281004	
400	Enduro 4t	00-02	281917		281004	
450	Enduro	04-	281917		281004	
450	MXF	05-	281917		281004	
530	Cross 4T	03-	281917		281004	
530	Enduro	04-	281917		281004	
530	Enduro 4T	03-	281917		281004	
530	MX F	05-	281917		281004	

TNT motor						
50	City	-	281949		281019	
50	Crazy	-	281919			
50	Ghost	-	281919			
50	Grido	-	281930G		281015	
50	Monza 2T	-	281930M			
50	Monza 4T	-	281930M			
50	Roma 10+	-	281949		281019	
50	Skiv	-	281949		281019	

FREINAGE FRENI PLAQUETTES DE FREIN PASTIGLIE FRENO

Cyl. Cil.	Modèle Modello	Année Anno	TNT / RB Original		SKY SARKANY	
			Avant Ant.	Arrière Post.	Avant Ant.	Arrière Post.
50	Strike	-	281930G		281015	
125	City	-	281949		281019	
125	Scooterone	-	281919	281930M		
125	STF	-	281930M	281930G		281015
125	STM	-	281930M	281930G		281015

TOMOS						
50	SE	04-	281922	281911	281008	281000A
50	Streemate	04-	281911		281000A	
50	Young STR Racing	04-	281911		281000A	
125	SE	04-	281922	281911	281008	281000A
125	SM	05-	281920	281911	281006	281000A

TRIUMPH						
750	Trident (left)	91-93	281919	281919		
750	Daytona	91-92		281919		
750	Daytona Sport	91-		281919		
900	Daytona	91-96		281919		
900	Daytona Super 3	94-		281919		
900	Speed Triple	94-96		281919		
900	Sprint	93-	281919			
900	Sprint	94-		281919		
900	Sprint (left)	93	281919	281919		
900	Sprint Sport Edition	97-		281919		
900	Tiger (left)	93-98	281919	281919		
900	Trident (left)	94-95	281919	281919		
900	Trophy	96-		281919		
900	Trophy (left)	91-95	281919	281919		
1000	Trophy (left)	91-	281919	281919		
1050	Tiger	07-		281919		
1100	Daytona Sport	91-		281919		
1200	Daytona	91-97		281919		
1200	Trophy	91-98	281919			
1200	Trophy	99-03		281919		

UVM						
50	Bingo	99-	281949		281019	
125	Bingo	99-	281949		281019	

VECTRIX						
3W	Electric	07-	281911	281917	281000A	281004
-	EL ELECTRICA	06-	281917	281917	281004	281004

VENTO						
110	Workman	06-	281930M			

VERTEMATI						
450	SR Motard Racing(SM3)	04-	281917		281004	
500	C Cross	02-	281917		281004	
501	E Enduro	02-	281917		281004	
501	S E Motard(SM3)	04-	281917		281004	
501	S Supermoto (SM3)	01-	281917		281004	
570	S E Motard(SM3)	03-	281917		281004	
570	S Motard(SM3)	03-	281917		281004	
600	SR Motard Racing(SM3)	04-	281917		281004	

VILLA						
50	AX / GZ	93-	281949		281019	

VOR						
350	TT Models	99-	281917		281004	
400	TT Models	99-	281917		281004	
450	TT Models	99-	281917		281004	
500	TT Models	99-	281917		281004	
530	TT Models	99-	281917		281004	

VOXAN						
1000	Black Magic	04-05		281920		281006
1000	Boxer	00-		281920		281006
1000	Café Racer	98-05		281920		281006
1000	Café Racer	06-		281920		281006
1000	Charade Racing	06-		281920		281006
1000	Roadster	98-05		281920		281006
1000	Roadster	06-		281920		281006
1000	Scrambler	02-		281919		

Cyl. Cil.	Modèle Modello	Année Anno	TNT / RB Original		SKY SARKANY	
			Avant Ant.	Arrière Post.	Avant Ant.	Arrière Post.
1000	Street Scrambler	04-		281919		
1000	VB Evo	04		281920		281006
1200	GTV	08-		281920		281006

YAMAHA						
50	Aerox	97-	281910	281912	281000	281001
50	Axis Cosmo	95-	281910		281000	
50	Axis Mofa	97-	281910		281000	
50	Axis Plus	95-	281910		281000	
50	Axis profoot	94-	281949		281019	
50	Breeze	94-	281910		281000	
50	BW'S Bump	96-	281910		281000	
50	BW's Next Generation	96-	281910		281000	
50	BW'S Original	96-	281910		281000	
50	BW'S R	94-95	281910		281000	
50	BW'S Spy	95-	281910		281000	
50	CR Target	91-	281949		281019	
50	CR Z	92-94	281949		281019	
50	Cygnus	96-	281918		281005	
50	DT LCD	98-03	281921		281007	
50	DT LCD	04-	281947	281911		281000A
50	DT R	05-	281911		281000A	
50	DT R	94-97	281918		281005	
50	DT Supermotard	03-04	281921		281007	
50	DT Supermotard	05-	281947			
50	FZR	90-91	281919			
50	JOG	92-93	281949		281019	
50	JOG (spain)	88-	281949		281019	
50	JOG R	94-01	281949		281019	
50	JOG-R	02-	281910		281000	
50	JOG-RR	02-	281910		281000	
50	JOG-Z	88-89	281949		281019	
50	JOG-Z	90-	281910		281000	
50	RS Champ	88-	281949		281019	
50	RZ	02-	281917A			
50	Slider	99-	281912		281001	
50	TDR	88-		281918		281005
50	TDR	90-	281918		281005	
50	TZM R	94-	281919	281918		281005
50	TZR	03-	281947	281911		281000A
50	TZR	90-92	281919	281918		281005
50	TZR	93-02	281919			
50	TZR	04-	281930A		281009A	
50	TZR RR	03-	281947	281911		281000A
50	TZR RR	98-02	281919	281918		281005
50	VH Why	98-	281910		281000	
50	YE Zest (Italy)	92-	281910		281000	
50	YE Zest (japan)	92-	281949		281019	
50	YN Neo's	97-	281910		281000	
50	YSR A/B	90-91	281918		281005	
50	YSR D	92-	281918		281005	
50	YSR T	86-	281918		281005	
50	YSR TAU/W	87-89	281918		281005	
60	YSR	86-	281918		281005	
80	DT LC	93-	281918		281005	
80	DT LC-2	85-	281918		281005	
80	RD Agua	87-	281918		281005	
80	RD LC	83-	281918		281005	
80	TDR	89-	281918		281005	
80	TRZ	92-	281949		281019	
80	TZR RR	92-	281919	281918		281005
80	YE Zest (Italy)	93-	281910		281000	
80	YE Zest (japan)	93-	281949		281019	
80	YSR	86-	281918		281005	
90	Axis pro foot	94-	281949		281019	
90	CR Target	91-	281949		281019	
90	JOG	90-	281949		281019	
90	YA Axis	90-	281949		281019	
100	Aerox	00-	281910		281000	
100	BW's	00-	281910		281000	
100	BW'S	02-	281948		281018	
100	BW'S	99-	281949		281019	
100	Neo's	00-	281910		281000	
125	XV S	99-	281930B		281010	
125	Cygnus R	96-02	281918		281005	
125	Cygnus X	04-	281922		281008	
125	DT	99-	281918	281918	281005	281005
125	DT LC	84-86	281918		281005	
125	DT LC	87	281930A		281009A	
125	DT R	87-04	281918	281918	281005	281005

FREINAGE FRENI PLAQUETTES DE FREIN PASTIGLIE FRENO

Cyl. Cil.	Modèle Modello	Année Anno	TNT / RD Original		SKY SARHANY	
			Avant Ant.	Arrière Post.	Avant Ant.	Arrière Post.
125	DT R	05-	281918		281005	
125	DT Ténéré	87-	281930A		281009A	
125	DT Z Ténéré	89-90	281930A		281009A	
125	Maxter	01-	281917	281920	281004	281006
125	SR	97-	281930K		281010A	
125	TDR R	93-	281930K	281918	281010A	281005
125	Teo's	01-	281910		281000	
125	TW	98-03	281917A			
125	TZR	93-	281930K		281010A	
125	TZR Marlboro Red Rocket	93-		281913		281002
125	Vino	03-	281918		281005	
125	X Max	06-		281920		281006
125	XC Cygnus	96-03	281918		281005	
125	XT R	05-	281911	281911	281000A	281000A
125	XT Supermotard	05-		281911		281000A
125	XT X	05-	281947			
125	XT X Supermotard	05	281922		281008	
125	XV Virago	97-	281930K		281010A	
125	YBR	05-	281918		281005	
125	YP Majesty	98-00	281917		281004	
125	YP R Majesty	01-	281917	281920	281004	281006
125	YZ	85-88		281918		281005
125	YZ U	88-		281918		281005
125	YZF R	08-	281917		281004	
150	Fly One R	98-	281918		281005	
150	Teo's	02-	281910		281000	
150	XC Fly One	92-	281918		281005	
150	XQ Maxter	01-	281917	281920	281004	281006
150	YP Majesty	01-	281917	281920	281004	281006
180	YP R Majesty	03-	281917	281920	281004	281006
200	DT R	85-89	281918	281918	281005	281005
200	DT R	89-	281918	281918	281005	281005
200	TT	85-86	281918		281005	
200	TW	98-03	281917A			
225	SEROW XT / TTR	85-	281918		281005	
225	XT	01-05	281917A			
225	XT E/H	92-00	281918		281005	
250	D Majesty DX	98-	281930K		281010A	
250	D Masjesty DX / ABS	99-	281930K		281010A	
250	Dragstar	01-	281930K		281010A	
250	FZX Zeal	91-	281930B		281010	
250	Majesty	96-	281930K		281010A	
250	Majesty DX	98-00		281917A		
250	Majesty DX / ABS	99-		281917A		
250	Serow	04-	281917A			
250	SRV	92-	281930B		281010	
250	Tricker XG	04-	281917A			
250	TT	85-	281918		281005	
250	TY R	91-92	281911		281000A	
250	TY Z	96-	281918		281005	
250	TYZ R	93-	281911	281911	281000A	281000A
250	X-City	07-		281917A		
250	X-Max	05-		281917A		
250	XT X	06-	281917A			
250	XV Virago	95-	281930K		281010A	
250	YBR	07-	281919			
250	YZ N/S Tri moto	85-86	281918	281918	281005	281005
250	YZ-U	88		281918		281005
300	VP Verity	03-	281917	281917	281004	281004
350	TT	91-	281918		281005	
350	XT	85-90	281918		281005	
350	XT B/H	91-	281918		281005	
350	YFM XT	87-	281918		281005	
350	YFM XU Warrior	87-88	281918		281005	
350	YZ Banshee T/U/W	87-89	281918		281005	
400	Artesia	91-		281918		281005
400	Majesty	04 - 05	281930K		281010A	
400	Majesty	04		281930L		281010B
400	XJ Diversion	91-	281930B		281010	
400	XT	86-	281918		281005	
400	YP Majestic	04-	281930B		281010	
450	WR F	03-		281919		
450	YZ F	03-07		281919		
500	T-Max	00-03	281930B		281010	
500	T-Max	04-	281930K	281930L	281010A	281010B
500	T-Max Cup	03-		281930L		281010B
500	WR B	91-		281918		281005
500	XT	86-	281918		281005	
500	XV S Virago	95-	281930B		281010	
500	YZ	88-		281918		281005

Cyl. Cil.	Modèle Modello	Année Anno	TNT / RD Original		SKY SARHANY	
			Avant Ant.	Arrière Post.	Avant Ant.	Arrière Post.
535	XV S Virago	95-	281930B		281010	
600	DT N	85-	281918		281005	
600	Fazer	04-	281930K		281010A	
600	S/N Diversion	98-	281930K		281010A	
600	SRX	96-		281913		281002
600	TT	85-88	281918		281005	
600	TT E	95-	281917		281004	
600	TT R	98-	281917		281004	
600	TT S	93-97	281917		281004	
600	TTS	94	281918	281918	281005	281005
600	XJ Diversion	91-97	281930B		281010	
600	XJ N Diversion	94-97	281930B		281010	
600	XT E/K	90-95		281918		281005
600	XTZ Tenere	87-90		281918		281005
600	YZF R-6	99-02		281917A		
650	XVS A Drag Star Classic	97-98	281930B		281010	
650	XVS Drag Star	97-	281930B		281010	
660	MT-3	06-	281930K		281010A	
660	SZR	96-97		281913		281002
660	XT Z Tenere	08-	281917		281004	
660	XTZ Tenere	91-93		281918		281005
750	XTZ Super Ténéré (right)	89-	281919	281919		
750	XV Virago	94-	281930B		281010	
900	XJ Diversion GT	99-	281930B		281010	
900	XJ S Diversion	95-	281930B		281010	
1000	YZF R1	02-03		281917A		
1100	XV Virago	95-98	281930B		281010	
1100	XVS DragStar	99-	281930B		281010	
1110	Dragstar	99-	281930K		281010A	
1300	XVS Midnight Star	07-	281930B		281010	
1300	XVZ TF Royal Star Venture	99-	281930B		281010	
1600	XV Wild Star	99-02	281930B		281010	

YAMAHA ATV						
450	YFM Wolverine	06-	281919			
450	YFZ S	03-06	281919			
660	YFZ Rhino (left)	05-	281919			
700	YFM R Raptor	06-	281919			

ZANELLA						
50	RM3	94-	281921		281007	
125	RZA	92-	281913		281002	

ZUNDAPP						
80	KS Super	80-	281913		281002	

FREINAGE FRENI

DISQUE DE FREIN FLOTTANT DISCO FRENO FLOTTANTE



*NITRO 13" Ø 240		4 TROUS 4 FORI	3 TROUS 3 FORI
NOIR BLACK	282053	282018	
BLEU BLUE	282053A	282018A	
ROUGE RED	282053B	282018B	
ARGENT SILVER	282053C	282018C	

*BOOSTER / BW'S Ø 180	
282016	NOIR NERO
282016A	BLEU BLU

DISQUE DE FREIN DISCO FRENO



*OVETTO / NEXT / 5FX / AEROX / NEOS	
282001	Ø 190

*BOOSTER	
282002A	Ø 180 4 TROUS FORI
282002B	Ø 240 4 TROUS FORI

*BOOSTER 96 > 99	
282000	Ø 155



*BUXY / TREKKER / VIVACITY	
282004	Ø 190

UNIVERSEL UNIVERSAL	
282010	Ø 190 3 TROUS FORI

UNIVERSEL UNIVERSALE	
282011	Ø 180 3 TROUS FORI



ETRIER DOUBLE PISTON PINZA DOPPIO PISTONCINO	
282051B	*DERBI SENDA / TREKKER

ETRIER DOUBLE PISTON PINZA DOPPIO PISTONCINO ORO	
282051A	*BOOSTER / TREKKER / TYPHOON

ETRIER DE FREIN PINZA PISTONCINO	
282051C	*PEUGEOT SPEEDFIGHT / LUDIX BLASTER / ELYSEO / ELYSTAR

ETRIER DOUBLE PISTON PINZA PISTONCINO	
282051	
PLAQUETTE DE FREIN PASTIGLIE FRENO	
281020	SARKANY (282051)

FREINAGE FRENI

FREIN A DISQUE FRENI A DISCO

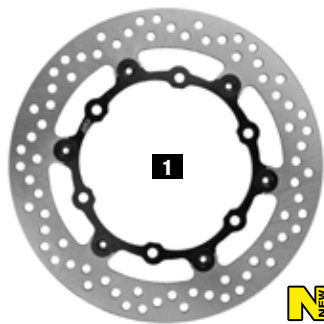

N
NEW

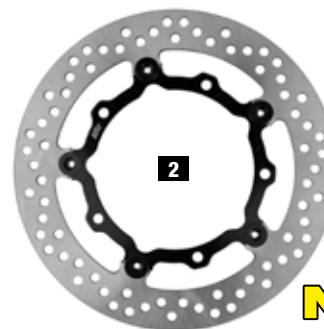

N
NEW

*YAMAHA TMAX 500 2008-11

282020 OEM : 4B52581T0000

267 \varnothing mm Externe Esterno **132** \varnothing mm Interne Interno **4** mm Epaisseur Spessore

8,5 \varnothing mm Perçage Fori **6** \bullet Troux Fori

FERODO : FMD0422
NEWFREN : .DF.4112 AF
NG : 1233
NG : 1195

YAMAHA	XP T-MAX ABS	500 2008/2011	SJ064
YAMAHA	XP T-MAX SV	500 2011/2011	SJ061
YAMAHA	XP T-MAX WHITE MAX	500 2010/2010	SJ061\SJ062
YAMAHA	XP T-MAX	500 2009/2011	SJ061\SJ062
YAMAHA	XP T-MAX ABS SV	500 2010/2011	SJ064
YAMAHA	XP T-MAX	500 2008/2008	SJ061\SJ062

*YAMAHA TMAX 500 / 530CC / XMAX 125 / 400CC

282020A OEM : 225162340

267 \varnothing mm Externe Esterno **132** \varnothing mm Interne Interno **4** mm Epaisseur Spessore

8,5 \varnothing mm Perçage Fori **5** \bullet Troux Fori

FERODO : FMD0437
BRAKING : RL8002
BRAKING : RF8116
EBC : MD9102D
NEWFREN : .DF.4089 A
NEWFREN : .DF.4089 AF
NG : 1081
NG : 1083

YAMAHA	XP530E-A T-MAX	530 2017/2017	SJ141
YAMAHA	XP530D-A T-MAX DX	530 2018/2018	
YAMAHA	XP530D-A T-MAX DX	530 2017/2017	SJ145
YAMAHA	XP T-MAX SP	530 2015/2015	SJ098
YAMAHA	XP T-MAX ABS	530 2012/2012	SJ092
YAMAHA	XP T-MAX	530 2015/2016	SJ098
YAMAHA	XP T-MAX	530 2013/2014	SJ091
YAMAHA	XP T-MAX	500 2004/2005	SJ031\SJ032
YAMAHA	XP T-MAX	500 2006/2006	SJ031\SJ032
YAMAHA	XP T-MAX	500 2007/2007	SJ051\SJ032
YAMAHA	XP530-A T-MAX SX	530 2017/2017	SJ142
YAMAHA	XP T-MAX SP ABS	530 2015/2016	SJ099
YAMAHA	XP T-MAX ABS	530 2015/2016	SJ099
YAMAHA	XP T-MAX ABS	530 2013/2014	SJ092
YAMAHA	XP T-MAX	530 2012/2012	SJ091
YAMAHA	XP T-MAX ABS	500 2006/2006	SJ034
YAMAHA	XP T-MAX ABS	500 2007/2007	SJ052
YAMAHA	XP T-MAX BLACK MAX	500 2006/2006	SJ031
YAMAHA	XP T-MAX ABS	500 2005/2005	SJ034
YAMAHA	YP400RA X-MAX ABS	400 2014/2014	SH072
YAMAHA	YP400RA X-MAX ABS	400 2015/2017	SH072
YAMAHA	YP400RA X-MAX	400 2018/2018	SH121
YAMAHA	YP400R X-MAX	400 2013/2014	SH071
YAMAHA	YP400R X-MAX	400 2015/2016	SH071

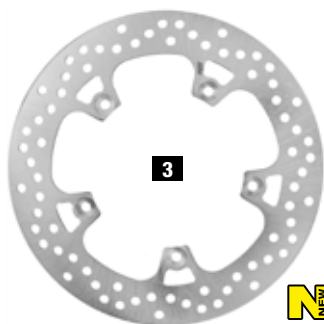

N
NEW

*YAMAHA XMAX 125 / XMAX 250CC

282020B OEM : 1B9F582U0000

267 \varnothing mm Externe Esterno **132** \varnothing mm Interne Interno **4,5** mm Epaisseur Spessore

8,5 \varnothing mm Perçage Fori **5** \bullet Troux Fori

YAMAHA	YP125R X-MAX ABS	125 2011/2011	SE544
YAMAHA	YP125R X-MAX	125 2010/2012	SE541
YAMAHA	YP125R X-MAX	125 2015/2016	SE681\SE686
YAMAHA	YP250R X-MAX	250 2005/2006	SG161
YAMAHA	YP250R X-MAX	250 2014/2016	SG261
YAMAHA	YP250RA X-MAX ABS	250 2012/2013	SG252
YAMAHA	YP250RA X-MAX ABS	250 2014/2015	SG262
YAMAHA	YP125R X-MAX	125 2006/2007	SE321
YAMAHA	YP125R X-MAX	125 2008/2009	SE321
YAMAHA	YP125R X-MAX	125 2012/2013	SG252
YAMAHA	YP125R X-MAX	125 2014/2014	SE681
YAMAHA	YP125RA X-MAX ABS	125 2013/2013	SE644
YAMAHA	YP125RA X-MAX ABS	125 2014/2015	SE684
YAMAHA	YP125RA X-MAX ABS	125 2016/2016	SE684
YAMAHA	YP125RA X-MAX ABS	125 2017/2017	SEC31
YAMAHA	YP250R BLACK X-MAX	250 2009/2009	SG162
YAMAHA	YP250R X-MAX SPORT	250 2011/2012	SG224
YAMAHA	YP250R X-MAX	250 2007/2009	SG162
YAMAHA	YP250R X-MAX	250 2010/2012	SG221
YAMAHA	YP250R X-MAX	250 2012/2013	SG251
YAMAHA	YP250RA X-MAX ABS	250 2011/2012	SG222
YAMAHA	YP250RA X-MAX ABS	250 2016/2016	SG262\SG266

FREINAGE FRENI

FREIN A DISQUE FRENI A DISCO

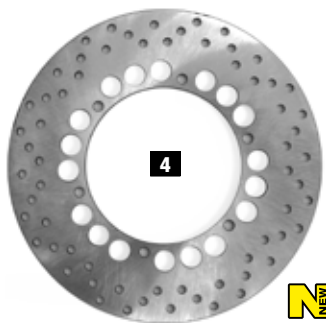

4 **NEW**

*YAMAHA TMAX 500 2001-07

282020C OEM : 5VU258W0000

267 mm Ø Externe Esterno **132** mm Ø Interne Interno **5** mm ✱ Epaisseur Spessore

8,5 mm Ø Percage Fori **5** mm ● Troux Fori

YAMAHA	XP T-MAX	500 2001/2003	SJ011\4\5\6
YAMAHA	XP T-MAX ABS	500 2005/2005	SJ034
YAMAHA	XP T-MAX ABS	500 2006/2006	SJ034
YAMAHA	XP T-MAX ABS	500 2007/2007	SJ052
YAMAHA	XP T-MAX	500 2004/2005	SJ031\SJ032
YAMAHA	XP T-MAX	500 2006/2006	SJ031\SJ032
YAMAHA	XP T-MAX BLACK MAX-NIGHT MAX	500 2007/2007	SJ031
YAMAHA	XP T-MAX BLACK MAX	500 2006/2006	SJ051\SJ032
YAMAHA	XP T-MAX	500 2007/2007	



4 **NEW**

*YAMAHA XMAX 125 / 250CC 2006-13

282020E ARRIERE OEM : 1B9F582W0100

240 mm Ø Externe Esterno **92** mm Ø Interne Interno **5** mm ✱ Epaisseur Spessore

8,5 mm Ø Percage Fori **4** mm ● Troux Fori

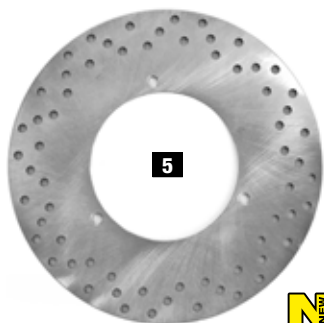

5 **NEW**

*YAMAHA XMAX 125 / 250CC 2011-16

282020D OEM : 1B72582W0000

245 mm Ø Externe Esterno **115** mm Ø Interne Interno **5** mm ✱ Epaisseur Spessore

8,4 mm Ø Percage Fori **3** mm ● Troux Fori

YAMAHA	YP125R X-MAX ABS	125 2011/2011	SE544
YAMAHA	YP125RA X-MAX ABS	125 2013/2013	SE644
YAMAHA	YP125RA X-MAX ABS	125 2014/2015	SE684
YAMAHA	YP250RA X-MAX ABS	250 2011/2012	SG222
YAMAHA	YP250RA X-MAX ABS	250 2014/2015	SG262
YAMAHA	YP250RA X-MAX ABS	250 2016/2016	SG262\SG266
YAMAHA	YP125RA X-MAX ABS	125 2016/2016	SE684
YAMAHA	YP125RA X-MAX ABS	125 2017/2017	SEC31
YAMAHA	YP250RA X-MAX ABS	250 2012/2013	SG252



8 **NEW**

*PIAGGIO FLY / VESPA ET2 / ET4 / LX

282021B OEM : 563246

200 mm Ø Externe Esterno **96** mm Ø Interne Interno **4** mm ✱ Epaisseur Spessore

6,5 mm Ø Percage Fori **5** mm ● Troux Fori

GILERA:

Runner VX 125 4T Grimeca de 2001 à 2003

PIAGGIO	libre 50cc	1997
Hexagon GT 250cc	1998 (v)	
Hexagon LX 125cc	1998	
Hexagon LXT 180cc	1998	
Sfera 125cc 4T Année	1996	
Sfera ET2 50cc année	1997	
Sfera RST année 50cc	1995	
Super Hexagon GTX GT 250cc	2000 (VH)	
Super Hexagon GTX 125cc	2000 (h)	
superbe Hexagon GTX 125cc	2000	
Super Hexagon GTX 180cc	2000 (VH)	
Vespa ET2 50cc	1997	
Vespa ET4 125cc	de 1997 à 2000	
Vespa ET4 150cc	1999	
Vespa PE 200cc	1998	
Vespa PX 125 150cc	1998	
Zip SP 50cc (2t)	1996 2001	
PAS adapté pour Piaggio SKR / modèles Skipper!		
Ils ont un diamètre intérieur de 98mm.		

FREINAGE FRENI

FREIN A DISQUE FRENI A DISCO



N
NEW

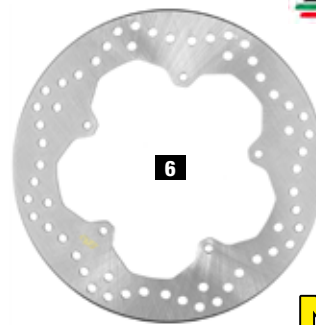

N
NEW

*PIAGGIO MP3 125 / 250 / 300 / 400 / 500CC

282021A OEM : 56394R - 649226

240 mm	Ø Externe Esterno	105 mm	Ø Interne Interno	4,1 mm	Epaisseur Spessore
6,6 mm	Ø Perçage Fori	6 mm	● Troux Fori		

Gilera
Runner 125 VX (2006-)
Runner 200 VXR (2006-)
Fuoco 500
Fuoco 500 Centenario

Piaggio
MP3 125
MP3 125 Hibrido
MP3 125 Touring
MP3 250 LT
MP3 250 MIC
MP3 300 LT
MP3 300 LT Hibrido V4
MP3 300 LT Sport
MP3 300 LT Touring
MP3 300 MIC
MP3 300 Touring
MP3 400
MP3 400 LT
MP3 400 LT Sport
MP3 400 LT Touring
MP3 400 MIC
MP3 400 Touring
MP3 500 LT Business
MP3 500 LT Sport
MP3 500 RL Sport
MP3 Yourban 300 LT
MP3 Yourban 125
MP3 Yourban 300

*PIAGGIO X8 / X9 / MP3 / GILERA RUNNER

282021 OEM : 649163

240 mm	Ø Externe Esterno	125 mm	Ø Interne Interno	4,5 mm	Epaisseur Spessore
6,5 mm	Ø Perçage Fori	5 mm	● Troux Fori		

FERODO : FMD0054
BRAKING : PI03FI
HTF : BD 055 ST
NEWFREN : .DF.4055 A
NG : 638

MP3 125 I.E.	2006=>2009	REAR R
MP3 125 HIBRIDO	2009=>2010	REAR R
MP3 125 RL	2006=>2007	REAR R
SUPER HEXAGON 125 GTX	2001	FRONT L
X7 125 X7 EVO 125 IE	2008=>2013	REAR R
X8 125	2004=>2009	REAR R/
X9 125 4T	2001=>2008	REAR L
X9 125 4T	2001=>2008	FRONT L-R
X-EVO 125	2007=>2011	REAR L
SUPER HEXAGON 180 GTX-12»	2001=>2003	FRONT L
X9 180 AMALFI 4T	2000=>2003	FRONT L-R
X9 180 AMALFI 4T	2000=>2003	REAR L
X8	200 2004	REAR L
X9 200	2002=>2003	FRONT L-R
X9 200	2002=>2003	REAR L
MP3 250 MP3 250 RL	2006=>2007	REAR R
/MP3 250 MIC	2008=>2009	REAR R
X7 250	2008=>2009	REAR R/
X8 250 PREMIUM I.E.	2006=>2009	REAR R
X9 250	2000=>2007	FRONT L-R
X9 250	2000=>2007	REAR L
X9 250 EVOLUTION	2000=>2007	FRONT L-R
X9 250 EVOLUTION	2000=>2007	REAR L
X-EVO 250 I.E.	2007=>2010	REAR L
MP3 300 LT IE LT	2010=>2011	REAR R
MP3 300 MIC IE MIC HIBRIDO	2010	REAR R
MP3 YOURBAN LT 300 IE	2012	REAR R
X7 EVO 300 I.E.	2009=>2013	REAR R
BEVERLY 400 I.E.	2006	REAR C
BEVERLY TOURER 400 I.E.	2007=>2008	REAR C
MP3 400 LT	2008=>2011	REAR R
MP3 400 LT SPORT	2008=>2010	REAR R
MP3 400 MIC	2008=>2009	REAR R
X8 400 IE	2006=>2009	REAR L
X-EVO 400 I.E.	2007=>2010	FRONT L-R
X-EVO 400 I.E.	2007=>2010	REAR L
BEVERLY 500	2002=>2004	REAR L
BEVERLY CRUISER 500 I.E.	2007=>2008	REAR L
MP3 TOURING 500 IE BUSINESS	2012	REAR R
MP3 TOURING 500 IE SPORT	2012	REAR R



N
NEW

*PIAGGIO LIBERTY / NRG / VESPA GTS

282021C AVANT OEM : 56391R - 56484R

220 mm	Ø Externe Esterno	105 mm	Ø Interne Interno	4,1 mm	Epaisseur Spessore
6,6 mm	Ø Perçage Fori	6 mm	● Troux Fori		

* Adaptable
* Adattabile

Les références du constructeur sont seulement indicatives et n'impliquent pas que les pièces de rechange viennent du constructeur.
I codici di riferimento originali sono indicativi e non implicano che i ricambi provengano necessariamente dalla stessa fabbrica del costruttore.

FREINAGE FRENI

FREIN A DISQUE FRENI A DISCO

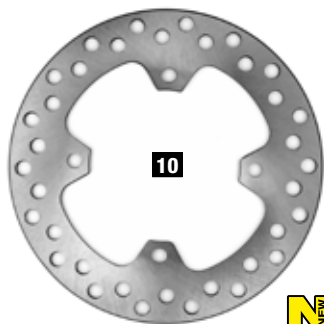

N

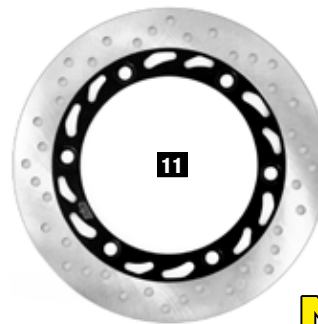

N

*HONDA SWING / PANTHEON / SH 125CC -150CC

282022A OEM : 45351-KRJ-901

220 mm	Ø Externe Esterno	105,3 mm	Ø Interne Interno	4 mm	✱ Epaisseur Spessore
10,5 mm	Ø Percage Fori	4 mm	● Trous Fori		

FERODO : FMD0057
BRAKING : H049FI
HTF : BD 059 ST
NEWFREN : .DF.4059 A
NG : 451

HONDA	PES 125 PS I	125 2008/2008	JF17A
HONDA	PES 125 PS I	125 2006/2006	JF17A
HONDA	PES 125 PS I	125 2007/2007	JF17A
HONDA	PES 125 PS I	125 2009/2009	JF17A
HONDA	PES 125 PS I	125 2010/2013	JF17A
HONDA	PES 150 PS I	150 2007/2007	KF09A
HONDA	PES 150 PS I	150 2008/2008	KF09A
HONDA	PES 150 PS I	150 2009/2009	KF09A
HONDA	PES 150 PS I	150 2006/2006	KF09A
HONDA	PES 150 PS I	150 2010/2010	KF09A
HONDA	SES 125 DYLAN	125 2002/2002	JF10A
HONDA	SES 125 DYLAN	125 2003/2003	JF10A
HONDA	SES 125 DYLAN	125 2004/2006	JF10A
HONDA	SES 150 DYLAN	150 2002/2002	KF05A
HONDA	SES 150 DYLAN	150 2003/2003	KF05A
HONDA	SES 150 DYLAN	150 2004/2004	KF05A
HONDA	SH 125	125 2003/2003	JF09A
HONDA	SH 125 I	125 2007/2007	JF14A
HONDA	SH 125 I	125 2008/2008	JF14A
HONDA	SH 150	150 2001/2002	KF04A
HONDA	SH 150	150 2003/2003	KF04A
HONDA	SH 150	150 2004/2004	KF04A
HONDA	SH 150 I	150 2006/2006	KF08A
HONDA	SH 125	125 2001/2002	JF09A
HONDA	SH 125	125 2004/2004	JF09A
HONDA	SH 125 I	125 2005/2005	JF14A
HONDA	SH 125 I	125 2006/2006	JF14A
HONDA	SH 150 I	150 2005/2005	KF08A
HONDA	SH 150 I	150 2007/2007	KF08A
HONDA	SH 150 I	150 2008/2008	KF08A

*HONDA SH 300 / FORZA 125 / SILVERWING 400

282022B OEM : 45351-KTW-901

256 mm	Ø Externe Esterno	144 mm	Ø Interne Interno	4,5 mm	✱ Epaisseur Spessore
10,5 mm	Ø Percage Fori	6 mm	● Trous Fori		

BRAKING : H051RID
BRAKING : RF7533
BRAKING : RF8118
BRAKING : H021FI
BRAKING : H021FID
NEWFREN : DF4103 A
NG : 1023
NG : 792

HONDA	NSS 125 AD FORZA ABS	125 2015/2016	JF60B
HONDA	SH 300 A I ABS	300 2007/2007	NF02B
HONDA	SH 300 A I ABS	300 2010/2010	NF02B
HONDA	SH 300 A I ABS	300 2011/2011	NF02D
HONDA	SH 300 A I ABS	300 2012/2012	NF02D
HONDA	SH 300 A I ABS	300 2013/2013	NF02D
HONDA	SH 300 A I ABS	300 2014/2015	NF02D
HONDA	SH 300 A I ABS	300 2008/2008	NF02B
HONDA	SH 300 A I ABS	300 2009/2009	NF02B
HONDA	SH 300 I	300 2008/2009	NF02A
HONDA	SH 300 I	300 2010/2010	NF02A



N

*HONDA SWING / PANTHEON / SH 125CC -150CC

282022 OEM : 45351-KRJ-901

240 mm	Ø Externe Esterno	105 mm	Ø Interne Interno	4 mm	✱ Epaisseur Spessore
10,5 mm	Ø Percage Fori	4 mm	● Trous Fori		

FERODO : FMD0057
BRAKING : H049FI
HTF : BD 059 ST
NEWFREN : .DF.4059 A
NG : 451

FREINAGE FRENI

FREIN A DISQUE FRENI A DISCO

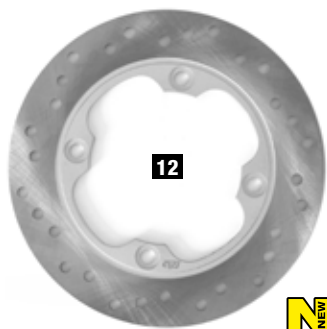

N

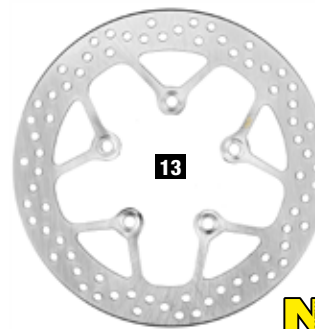

N

*HONDA SH / S-WING / PANTHEON

282022C OEM : 43251-MV4-00

220 mm	∅ Externe Esterno	105 mm	∅ Interne Interno	5 mm	✱ Epaisseur Spessore
10,6 mm	∅ Perçage Fori	4 mm	● Trous Fori		

BRAKING : HO50RID
 BRAKING : HO22RI
 BRAKING : HO22RID
 EBC : MD1004
 NEWFREN : DF4060 A
 NG : 101
 NG : 101A
 NG : 101X
 NG : 101XA

HONDA 125 PANTHEON 2003/2007

HONDA	FES 250 FORESIGHT	250 2000/2000	MF05A
HONDA	FES 250 FORESIGHT	250 2001/2001	MF05A
HONDA	FES 250 FORESIGHT	250 2002/2004	MF05A
HONDA	FES 250 FORESIGHT	250 2005/2005	MF05A
HONDA	NSS 250 JAZZ ABS	250 2004/2004	MF06B
HONDA	NSS 250 JAZZ ABS	250 2001/2002	MF06B
HONDA	NSS 250 JAZZ ABS	250 2003/2003	MF06B
HONDA	NSS 250 JAZZ	250 2001/2001	MF06A
HONDA	NSS 250 JAZZ	250 2003/2003	MF07A
HONDA	NSS 250 JAZZ	250 2004/2004	MF07A
HONDA	NSS 250 JAZZ ES 250	2001/2002	MF07A
HONDA	NSS 250 JAZZ ES 250	2003/2003	MF07A
HONDA	NSS 250 JAZZ ES 250	2004/2004	MF07A

*KYMCO AGILITY 50 / 125CC R16

282023 OEM : 00145010

260 mm	∅ Externe Esterno	87,5 mm	∅ Interne Interno	4 mm	✱ Epaisseur Spessore
8,5 mm	∅ Perçage Fori	5 mm	● Trous Fori		

FERODO : FMD0323
 BRAKING : RF8117
 BRAKING : S38007
 NEWFREN : .DF.4080 A
 NG : 1093

AGILITY 2T 4T R16 50	2008=>2012	FRONT L
AGILITY 2T 4T R16 50	2014	FRONT L
AGILITY CITY 50	2008=>2012	FRONT L
PEOPLE S 50	2005=>2008	FRONT L
PEOPLE S 50 4T	2006=>2008	FRONT L
AGILITY CITY 125	2009=>2012	FRONT L
AGILITY R16 125	2014	FRONT L
PEOPLE GTI 125	2010=>2011	FRONT R
PEOPLE S 125	2007=>2011	REAR R
PEOPLE S 125	2007=>2011	FRONT L
AGILITY 150 R16	2008=>2012	FRONT R
AGILITY CITY 200 I	2012	FRONT L
PEOPLE GTI 200	2010=>2011	FRONT R
PEOPLE S 200 S 200 I	2005=>2011	FRONT L
PEOPLE S 200 S 200 I	2005=>2011	REAR R
PEOPLE LC 250	2003=>2004	FRONT L
PEOPLE LC 250	2003=>2004	REAR R
PEOPLE S 250 I	2006=>2010	FRONT L-R
PEOPLE S 250 I	2006=>2010	REAR R
PEOPLE S 300 I	2008=>2010	REAR R
PEOPLE S 300 I	2008=>2010	FRONT L-R

* Adaptable
 * Adattabile

Les références du constructeur sont seulement indicatives et n'impliquent pas que les pièces de rechange viennent du constructeur.
 I codici di riferimento originali sono indicativi e non implicano che i ricambi provengano necessariamente dalla stessa fabbrica del costruttore.

FREINAGE FRENI PATIN DE FREIN PATINO FRENO

TNT
Original



***SOLEX**

S30874 PIECE

COUVERCLE RESERVOIR COPERCHI POMPA FRENO

TNT
Tuning



***BOOSTER 2004 / BW'S 2004 / STUNT / SLIDER**

280006B CHROME CROMO

280006C STYLE CARBONE CARBONIO

280006E BLANC BIANCO



***NITRO / AEROX**

280010A BLANC BIANCO

280011 STYLE CARBONE CARBONIO

280012 CHROME CROMO

X2



BOCAL DE MAITRE CYLINDRE

SERBATOIO POMPA FRENO

282049 Ø 38MM



N

**MAITRE CYLINDRE DE FREIN ARRIERE COMPLET
POMPA FRENO POSTERIORE COMPLETO**

282049C ENTRAXE 45MM



N

**MAITRE CYLINDRE DE FREIN UNIVERSEL
POMPA FRENO UNIVERSALE**

282049A DROIT DESTRA

282049B GAUCHE SINISTRA



N

**MAITRE CYLINDRE DE FREIN UNIVERSEL
POMPA FRENO UNIVERSALE**

282049D DROIT DESTRA

282049E GAUCHE SINISTRA

FREIN A PIED 5OCC A BOITE 5OCC 6 SPEED FOOT BRAKE

TNT
Tuning



***PEUGEOT XP6 / MBK XLIMIT**

FREIN A PIED ALU PEDALE FRENO ALLUMINIO

280091A ROUGE ANODISE ROSSO ANODIZZATO

280091B NOIR ANODISE NERO ANODIZZATO

280091C STYLE CARBONE CARBONIO



***DERBI SENDA**

FREIN A PIED ALU PEDALE FRENO ALLUMINIO

280092 BLEU ANODISE BLU ANODIZZATO

280092A ROUGE ANODISE ROSSO ANODIZZATO

280092B NOIR ANODISE NERO ANODIZZATO

280092C STYLE CARBONE CARBONIO

PNEUMATIQUE

- > INFORMATIONS TECHNIQUES
- > PNEU MICHELIN
- > PNEU DURO
- > PNEU MAXIMA
- > PNEU SAVA
- > CHAMBRE A AIR
- > REPARATION PNEUMATIQUE
- > ACCESSOIRE DE ROUE

PNEUMATICI

- > INFORMAZIONI TECNICHE
- > PNEUMATICI
- > PNEUMATICI
- > PNEUMATICI
- > PNEUMATICI
- > CAMERE D'ARIA
- > RIPARAZIONE
- > ACCESSORI

EQUIVALENCE DES DIMENSIONS PNEUS SCOOTERS NON RADIAUX			
EQUIVALENZE DELLE DIMENSIONI PNEUMATICI SCOOTER NON RADIALI			
PNEUS À ARCHITECTURE DIAGONALE		PNEUMATICI AD ARCHITETTURA DIAGONALE	
DIMENSIONS EN MILLIMÉTRIQUES	DIMENSIONI IN MILLIMETRI		DIMENSIONS EN POUCES
			DIMENSIONI IN POLLICI
80/80		◄►	2,75
80/90		◄►	2,75 - 3,00
90/90		◄►	3,00 - 3,25 - 3,60
100/90		◄►	3,50 - 4,10
110/90		◄►	4,00 - 4,10 - 4,60
120/80		◄►	4,25 - 4,50 - 4,60
120/90		◄►	4,25 - 4,50
130/80		◄►	4,50 - 4,60 - 5,10
130/90		◄►	4,50 - 4,60 - 5,10
140/80		◄►	4,50 - 5,10 - 5,50
140/90		◄►	5,10 - 5,50

EQUIVALENCE DES DIMENSIONS PNEUS MOTO NON RADIAUX				
EQUIVALENZE DELLE DIMENSIONI PNEUMATICI MOTO NON RADIALI				
	POUCES POLLICI		MILLIMÈTRES MILLIMETRI	
		SERIE BASSE	SERIE 90	SERIE 80
16"	3,25 - 16		100/90 - 16	110/80 - 16
	3,50 - 16	4,60 - 60	110/90 - 16	120/80 - 16
			120/90 - 16	
17"	5,00 - 16	5,10 - 16	130/90 - 16	150/80 - 16
	2,50 - 17	3,10 - 17	80/90 - 17	
	2,75 - 17	3,10 - 17	80/90 - 17	
	4,25 - 17		120/90 - 17	130/80 - 17
18"	4,50 - 17	5,10 - 17	130/90 - 17	140/80 - 17
	2,50 - 18			
	2,75 - 18	3,10 - 18	80/90 - 18	
	3,00 - 18	3,10 - 18	80/90 - 18	
	3,25 - 18	3,60 - 18	90/90 - 18	100/80 - 18
	3,50 - 18	4,10 - 18	100/90 - 18	110/80 - 18
	3,75 - 18	4,10 - 18	100/90 - 18	110/80 - 18
	4,00 - 18	4,25/85 - 18	110/90 - 18	120/80 - 18
		4,60 - 18	120/90 - 18	130/80 - 18
	4,25 - 18		130/90 - 18	140/80 - 18
19"	3,00 - 19			
	3,25 - 19		90/90 - 19	
	3,50 - 19	4,10 - 19	100/90 - 19	
21"			110/90 - 19	
	2,75 - 21		80/90 - 21	
	3,00 - 21		90/90 - 21	

PNEUMATIQUE PNEUMATICI

INFORMATIONS TECHNIQUES INFORMAZIONI TECNICHE

INDICE DE CHARGE INDICE DI CARICO

INDICE	Kg	INDICE	Kg	INDICE	Kg
0	45,0	40	140,0	80	450,0
1	46,2	41	145,0	81	462,0
2	47,5	42	150,0	82	475,0
3	48,7	43	155,0	83	487,0
4	50,0	44	160,0	84	500,0
5	51,5	45	165,0	85	515,0
6	53,0	46	170,0	86	530,0
7	54,5	47	175,0	87	545,0
8	56,0	48	180,0	88	560,0
9	58,0	49	185,0	89	580,0
10	60,0	50	190,0	90	600,0
11	61,5	51	195,0	91	615,0
12	63,0	52	200,0	92	630,0
13	65,0	53	206,0	93	650,0
14	67,0	54	212,0	94	670,0
15	69,0	55	218,0	95	690,0
16	71,0	56	224,0	96	710,0
17	73,0	57	230,0	97	730,0
18	75,0	58	236,0	98	750,0
19	77,5	59	243,0	99	775,0
20	80,0	60	250,0	100	800,0
21	82,5	61	257,0	101	825,0
22	85,0	62	265,0	102	850,0
23	87,5	63	272,0	103	875,0
24	90,0	64	280,0	104	900,0
25	92,5	65	290,0	105	925,0
26	95,0	66	300,0	106	950,0
27	97,5	67	307,0	107	975,0
28	100,0	68	315,0	108	1000,0
29	103,0	69	325,0	109	1030,0
30	106,0	70	335,0	110	1060,0
31	109,0	71	345,0	111	1090,0
32	112,0	72	355,0	112	1120,0
33	115,0	73	365,0	113	1150,0
34	118,0	74	375,0	114	1180,0
35	121,0	75	387,0	115	1215,0
36	125,0	76	400,0	116	1250,0
37	128,0	77	412,0	117	1285,0
38	132,0	78	425,0	118	1320,0
39	136,0	79	437,0	119	1360,0

INDICE DE VITESSE INDICE DI VELOCITA

INDICE	Km/h
A1	5
A2	10
A3	15
A4	20
A5	25
A6	30
A7	35
A8	40
B	50
C	60
D	65
E	70
F	80
G	90
J	100
K	110
L	120
M	130
N	140
P	150
Q	160
R	170
S	180
T	190
U	200
H	210
V	240
W	270

DIMENSIONS
DIMENSIONI

130/60-13 M/C

INDICE DE CHARGE
INDICE DI CARICO

60

INDICE DE VITESSE
INDICE DE VELOCITA

P

PNEU TUBELESS
TUBELESS

TL

PROFIL
PROFILO

MC 16

* Adaptable
* Adattabile

Les références du constructeur sont seulement indicatives et n'impliquent pas que les pièces de rechange viennent du constructeur.
I codici di riferimento originali sono indicativi e non implicano che i ricambi provengano necessariamente dalla stessa fabbrica del costruttore.

LES SCOOTERS VONT ENFIN ADORER LA PLUIE.



MICHELIN
CITY 

Vous ne pouvez plus vous passer de votre scooter ? Grâce à la nouvelle MICHELIN Progressive Sipe Technology PST, MICHELIN CityGrip vous évitera les glissades sur sol mouillé, bandes blanches et autres plaques d'égout. MICHELIN City Grip vous offre ainsi :

- Des lamelles « pleine profondeur » qui brisent le film d'eau quelque soit l'usure du pneu.
- Une augmentation progressive du nombre de lamelles au fur et à mesure de la prise d'angle.

MICHELIN City Grip vous permet de garder le contrôle de votre véhicule en toutes circonstances. Bref, votre scooter va enfin adorer la pluie !

www.michelin.com



PNEUMATIQUE PNEUMATICI

SCOOTER & MAXI SCOOTER SCOOTER & MAXI SCOOTER



POWER PURE SC

		AVANT ANT.	ARRIERE POST.
12"	120 X 70 X 12	S35261 (51P)	
	130 X 70 X 12	S35726 (56P)	S35262 (62P)
	140 X 70 X 12		S35263 (53P)
13"	130 X 60 X 13		S35264 (53P)
	140 X 60 X 13		S35731 (57L)
	120 X 70 X 13		S35732 (53P)
	130 X 70 X 13		S35727 (63P)
	130 X 70 X 13		S35728 (57P)
14"	150 X 70 X 13		S35266
	120 X 80 X 14		S35268 (58S)



CITY GRIP

		CITY GRIP	AVANT ANT.	ARRIERE POST.
10"	120 X 70 X 10			S35729 (54L)
11"	110 X 70 X 11	S35730 (54L)		
12"	120 X 70 X 12		S35260 (51S)	
	120 X 70 X 12		S5425 (51P)	
	130 X 70 X 12		S5423 (62P)	251609 (56P)
13"	110 X 70 X 13		251602A (48P)	
	140 X 60 X 13		S466678	
14"	120 X 70 X 14		S5428 (55)	
	140 X 60 X 14	S5369 (64P)		
	140 X 70 X 14	S5429 (68S)		S5429 (68S)
	140 X 70 X 14	S5370		
	110 X 80 X 14			251610 (59S)
15"	90 X 90 X 14			S466679
	100 X 90 X 14		S466680	
	120 X 70 X 15		S640949	
16"	140 X 70 X 15		251602B (69P)	
16"	140 X 70 X 16	S5431 (65P)		
	900 X 80 X 16		251611 (51S)	



CITY GRIP WINTER

		AVANT ANT.	ARRIERE POST.
10"	3.50 X 10	251600 (59J)	
12"	120 X 70 X 12		251602 (58S)
	130 X 70 X 12	251604 (62P)	
14"	140 X 60 X 14		251605 (64S)
	140 X 70 X 14		251606 (68S)



S1

10"	90 X 90 X 10	S841015 (50J)
	110 X 80 X 10	S223490 (58J)
	130 X 70 X 10	S237280 (62J)

* Adaptable
* Adattabile

Les références du constructeur sont seulement indicatives et n'impliquent pas que les pièces de rechange viennent du constructeur.
I codici di riferimento originali sono indicativi e non implicano che i ricambi provengano necessariamente dalla stessa fabbrica del costruttore.

PNEUMATIQUE PNEUMATICI

SCOOTER & MAXI SCOOTER SCOOTER & MAXI SCOOTER



BOPPER

10"	120 X 90 X 10	S256430 (57L)
	130 X 90 X 10	S256440 (61L)
12"	120 X 70 X 12	S104772 (50L)
	130 X 70 X 12	S104984 (56P)



PILOT POWER 3

15"	120 X 70 X 15	S810102 (56H)
	160 X 60 X 15	S810103 (67H)



PILOT ROAD 4

15"	120 X 70 X 15	S810105 (56H)
	160 X 60 X 15	S810104 (67H)



S83

10"	100/90 X 10	S841036A (56J)



REGGAE

10"	120 X 90 X 10	S220120 (57J)
	130 X 90 X 10	S220110 (61J)



10"	120 X 90 X 10	S821946D (57P)
	130 X 90 X 10	S821946C (61P)
	3.50 X 10	S821946G (59P)
12"	120 X 70 X 12	S821946B (58P)
	130 X 70 X 12	S821946A (62P)
13"	130 X 60 X 13	S821946E (60P)
	140 X 60 X 13	S821946F (63P)

Nouveau pneu MICHELIN City grip Winter, plus de sérénité en hiver.



Avec le nouveau pneu MICHELIN City grip Winter, c'est plus de sérénité en hiver sur votre scooter. En effet, il offre plus de grip sur routes mouillées*, sèches ou enneigées** ainsi qu'un freinage efficace. De plus, sa mise en régime rapide, sa stabilité et sa maniabilité vous apportent du confort dans les conditions les plus difficiles.

Ainsi, avec MICHELIN Total Performance, c'est davantage de performances réunies.

* Selon tests internes réalisés en 2013, avec le nouveau pneu MICHELIN City Grip Winter un gain de 4 secondes au tour vs. MICHELIN City Grip.
** Selon tests internes réalisés en 2013 démontrant le potentiel d'adhérence sur neige supérieur du nouveau pneu MICHELIN City Grip Winter vs. MICHELIN City Grip.



PNEUMATIQUE PNEUMATICI

SCOOTER & MAXI SCOOTER SCOOTER & MAXI SCOOTER

DURO



HF-228

8"	3.50 X 8	251212A
10"	3.00 X 10	251212
	3.50 X 10	251212B



HF 291

10"	1/2 SLICK	
	100 X 90 X 10	251152 (56J)



HF 263A

10"	1/2 SLICK	
	300 X 10	251161 (42J)
	350 X 10	251162 (51J)



DM 1068

10"	1/2 SLICK	
	100 X 80 X 10	251221 (54L)
	120 X 70 X 10	251222 (54L)



HF 296 A

10"	1/2 SLICK	
	100 X 80 X 10	251151 (52J)
	110 X 80 X 10	251190 (58J)
	130 X 70 X 10	251169 (62J)
12"	120 X 70 X 12	251210 (56J)
	130 X 70 X 12	251211 (58J)
	140 X 70 X 12	251185 (60J)
13"	130 X 60 X 13	251180 (55J)



DM 1092A

10"	1/2 SLICK	
	100 X 90 X 10	251154 (56J)
	300 X 10	251159 (42J)
13"	120 X 60 X 13	251149A (55R)
	130 X 60 X 13	251149B (60R)



HF 260

10"	1/2 SLICK	
	130 X 90 X 10	251164 (61J)



HF 290

10"	1/2 SLICK	
	120 X 90 X 10	251167 (56J)
	130 X 90 X 10	251168 (61J)



HF 912A

12"	1/2 SLICK	
	110 X 70 X 12	251210B (47J)
	120 X 70 X 12	251210A (51J)
	130 X 70 X 12	251211A (59J)



HF 916

13"	1/2 SLICK	
	130 X 60 X 13	251180A (55J)
	140 X 60 X 13	251181 (57L)



DM 1107

10"	RACING SPORT	
	90 X 90 X 10	251148A (50M)
	100 X 90 X 10	251148 (56M)
	350 X 10	251148B (51M)

PNEUMATIQUE PNEUMATICI

SCOOTER & MAXI SCOOTER SCOOTER & MAXI SCOOTER

DURO



DM 1017
RACING SPORT

10"	90 X 90 X 10	251150 (50J)

12"	120 X 70 X 12	251214 (56J)
	130 X 70 X 12	251215 (62M)
	140 X 70 X 12	251216 (65P)



DM 1060
RACING CITY

12"	120 X 70 X 12	251149C (51L)
	130 X 70 X 12	251149D (56L)

13"	110 X 90 X 13	251224A (56P)

16"	110 X 70 X 16	251224 (53P)



DM 1091
RACING CITY RAIN

12"	120 X 70 X 12	251149E (58M)
	130 X 70 X 12	251149F (62L)



DM 1092
RACING CITY

12"	110 X 70 X 12	251149 (47R)



DM 1057
ROAD

13"	130 X 70 X 13	251225A (63P)

16"	140 X 70 X 16	251225 (65P)



HF 903
ROAD

10"	120 X 90 X 10	251165 (56J)
	130 X 90 X 10	251166 (61J)

12"	120 X 70 X 12	251200 (56J)
	130 X 70 X 12	251201 (58J)

13"	130 X 60 X 13	251205 (55J)



HF 348
ROAD

16"	90 X 80 X 16	251223 (54J)
	100 X 80 X 16	251223A (54J)



DM 1075
ROAD

16"	120 X 80 X 16	251228 (60P)



DM 1059
TUBELESS

12"	110 X 90 X 12	251217 (64P)



HF 910
OFF ROAD

10"	120 X 90 X 10	251195 (54J)
	130 X 90 X 10	251196 (61J)

* Adaptable
* Adattabile

Les références du constructeur sont seulement indicatives et n'impliquent pas que les pièces de rechange viennent du constructeur.
I codici di riferimento originali sono indicativi e non implicano che i ricambi provengano necessariamente dalla stessa fabbrica del costruttore.



HF 918		
TUBELESS		
16"	120 X 80 X 16	251035 (60H)
17"	110 X 70 X 17	251040 (54H)



HF 297		
TUBELESS		
17"	100 X 80 X 17	251045 (52H)
	120 X 80 X 17	251046 (61H)



HF 903		
TRIAL & ROAD		
21"	90 X 90 X 21	251030 (54S)



EXCELEATOR		
OFF ROAD		
18"	110/100-18	251850A (64M)
19"	100/90-19	251850B (57M)
	110/90-19	251850C (62M)
21"	80/100-21	251850 (51M)

CYCLE CICLOMOTORE



LIGNE		
ROAD		
16"	250 X 16	251175
	275 X 16	251176



HF 311		
TUBELESS		
16"	250 X 16	251186 (4PR)
17"	250 X 17	251186A (4PR)



HF 245

8"	18 X 11 X 8	251507 NH
9"	20 X 11 X 9	251509 NH
10"	20 X 11 X 10	251510 NH



D12003

7"	16 X 8 X 7	251512 NH
10"	22 X 7 X 10	251513
	22 X 10 X 10	251514



HF 240 A & B

6"	145 X 70 X 6	251505 NH
7"	16 X 8 X 7	251500
8"	18 X 9,5 X 8	251506
9"	25 X 12 X 9	251508 NH



HF 246

8"	19 X 7 X 8	251502



HF 247

8"	18 X 9,5 X 8	251504
	19 X 7 X 8	251503
10"	21 X 7 X 10	251511



D12014

9"	22 X 10 X 9	251517A
10"	21 X 7 X 10	251517



D12019

10"	21 X 7 X 10	251519
	22 X 22 X 10	251518



DI 2010

12"	25 X 8 X 12	251515
	25 X 10 X 12	251515A



DI 2013

12"	25 X 8 X 12	251516 NH
	25 X 10 X 12	251516A NH

NH : NON HOMOLOGUÉ - NON OMOLOGATO

* Adaptable
 * Adattabile

Les références du constructeur sont seulement indicatives et n'impliquent pas que les pièces de rechange viennent du constructeur.
 I codici di riferimento originali sono indicativi e non implicano che i ricambi provengano necessariamente dalla stessa fabbrica del costruttore.

PNEUMATIQUE PNEUMATICI

SCOOTER & MAXI SCOOTER SCOOTER & MAXI SCOOTER



N

FORCE-SC

12"	120 X 70 X 12	251620 (51L)
	120 X 70 X 12	251620A (51S)
	120 X 70 X 12	251620B (58P)
	130 X 70 X 12	251620C (56L)
	130 X 70 X 12	251620D (64P)
14"	100 X 90 X 14	251620E (57P)
	140 X 60 X 14	251620F (64S)
	140 X 70 X 14	251620G (68S)
15"	120 X 70 X 15	251620H (56S)



MC12

10"	3.00 X 10	S61805 (42J)



MC28

14"	120 X 70 X 14	251190A (55P)



MC26

14"	80 X 80 X 14	S511668 (53L)



MC7

18"	300 x 18	S82854



B13

8"	400 X 8C	S82408 (4PR)



MC17

10"	150 X 80 X 10	S147170 (65L)
	120 X 90 X 10	S147170A (65L)
	130 X 90 X 10	S147170B (65L)



MC20

10"	120 X 70 X 10	S5982 (54L)
11"	110 X 70 X 11	S5983 (45L)

> SCOOTER



MC19

12"

130 X 80 X 12	251192
130 X 80 X 12	251192A

> MAXI SCOOTER



MC32

12"

120 X 70 X 12	36252 (58P)
130 X 70 X 12	36255 (62P)

14"

100 X 70 X 14	36254 (53L)
80 X 80 X 14	36253 (53L)
110 X 80 X 14	36257 (59L)

16"

110 X 70 X 16	36258 (52P)
90 X 80 X 14	36256 (52P)



> MOTO



MC50

17"

100 X 70 X 17	S821946 (52H)
130 X 70 X 17	S821947 (62H)



MC25

17"

100 X 80 X 17	S821945 (52R)
130 X 70 X 17	S821944 (62R)



MC23

18"

110 X 80 X 18	S82711
---------------	--------

21"

80 X 90 X 21	S821035 (48P)
--------------	---------------



PIT BIKE MITAS

10"

	AVANT ANT.	ARRIERE POST.
2.50 X 10	251608D (33J)	251608D (33J)

12"

80/100 X 12	251608E (50M)	
-------------	---------------	--

* Adaptable
* Adattabile

Les références du constructeur sont seulement indicatives et n'impliquent pas que les pièces de rechange viennent du constructeur.
I codici di riferimento originali sono indicativi e non implicano che i ricambi provengano necessariamente dalla stessa fabbrica del costruttore.

> CYCLO CICLOMOTORE



MC2		
16"	225 X 16	S65765 (38J)
	250 X 16	S427008 (42J)
	275 X 16 tubeless	S427009



MC11		
17"	2 X 17	S427003 (31J)
	250 X 17	S427010 (43J)
	225 X 17	S23417 (39J)
	275 X 17	S427011 (47J)



B8		
16"	225 X 16	S427005 (38J)
	250 X 16	S427002



B4		
17"	225 X 17	S427012 (39J)
18"	225 X 18	S427004 (42J)



B7		
17"	275 X 17	S427013 (47J)

> CYCLO CICLOMOTORE



SPHERUS		
16"	250 X 16	S69528 (TL)
	225 X 16	S69526 (TT)
17"	225 X 17	S69530



VROOM		
16"	250 X 16	S51808
	225 X 16	
17"	200 X 17	S1781
18"	225 X 18	S1882



GP1		
16"	275 X 16	S16341
17"	225 X 17	S177225
	250 X 17	S177250



TURBO		
17"	225 X 17	S51736
	275 X 17	S51737

#MitasMoto
#Scooter
#RideMitas



TOURING FORCE-SC



NOUVEAU

La gamme TOURING FORCE-SC est développée pour tous types de scooter afin d'assurer des trajets courts urbain ou des longues distances de voyage. Disponible progressivement dans un large choix de tailles courant 2018 et 2019. Renseignement auprès de notre conseiller commercial.

mitas-moto.com

 Mitas Moto

Mitas

PNEUMATIQUE PNEUMATICI CHAMBRE A AIR CAMERE D'ARIA



MICHELIN			
8"			
S84408	3.50 X 8		8B1
S843500	400 X 8		8B4
S4008	3.80/90 X 8		8B3
10"			
S4510	130/90 X 10		10CG13
S103500	300/3.50 X 10	VALVE DROITE	10B1
S103501	300/3.50 X 10	VALVE COUDÉE	10B4
12"			
S30012	300/3.50 X 12		B1
14"			
S125389	90/100 X 14	RENFORCÉE	14TT
16"			
S163000	300/325 X 16		16MF
17"			
S17300	2.50/2.75 X 17		17MC
17"			
S174001	400 X 17		17MG
S364698	130/70 X 17		17MH
S173005	300 X 17		17ME
S174502	4.25 X 17		17MI
18"			
S184100	120/90 X 18		18MFR
S18300	2.75-300 X 18		18ME
S183250	3.25/3.50 X 18		18MF
S184000	400 X 18		18CG
S1839	400/4.25 X 18		18MG
19"			
S19325	325 X 19		19MF
21"			
S212750	2.50 X 21		21MD
14"			
S931670	60/100 X 14		MBR



TDH			
8"			
251350	3.50/4.00 X 8		JS87 90/90
10"			
251351	2.50/3.50 X 10		JS87 90/90
251352	3.50/4.50 X 10		JS87 90/90
12"			
251353	2.50/3.00 X 12		JS87 90/90
251354	4.00/4.50 X 12		JS87 90/90
13"			
251355	130-140/60 X 13		JS87 90/90
14"			
251357	120/70 X 14	140/60 X 14	TR4
251356	60/100 X 14	80/80 X 14	TR4
251380	2.25→2.75 X 14	60/100 X 14	TR4
15"			
251358	130/90 X 15	150/90 X 15	TR4
16"			
251359	2.25 X 16		TR4
251360	2.50/2.75 X 16		TR4
251361	3.00/3.25 X 16		TR6
251362	4.50/5.10 X 16		TR4
251381	3.25/3.50 X 16	90/100 X 16	TR4
17"			
251363	2.00/2.25 X 17		TR4
251364	2.75/3.00 X 17		TR6
251365	3.00/3.25 X 17		TR4
251366	4.25-5.10 X 17		TR4
18"			
251367	2.25/2.50 X 18		TR4
251368	2.75→3.25 X 18		TR6
251369	4.00→5.00 X 18		TR4
251382	100/100 X 18	110/100-100/90 X 18	TR4
251383	140/80 X 18	110/100-120/90-130/80 X 18	TR4
251387	110/100 X 18	100/100-100/90 X 18	TR4
251388	140/80 X 18	120/90-130/80 X 18	TR4
19"			
251370	3.25/3.50 X 19		TR6
251385	100/90-110/90 X 19	120/80-130/70 X 19	TR4
251384	70/100 X 19		TR4
251389	100/90-110/90 X 19	120/80-130/70 X 19	
21"			
251371	2.50→3.25 X 21		TR4
251386	2.50→3.25 X 21	80/90-80/100-90/90-90/100 X 21	TR4
251390	90/90 X 21	80/100 X 21	TR4



TNT ORIGINAL			
10"			
251260	300-350 X 10		JS87
251261	120-130/90 X 10		JS87
12"			
960209Z	1/2-2.75 X 12	DIRT 50 AV/AR	
13"			
251263	120-130/60 X 13		
16"			
254100	250-275 X 16		
17"			
254105	250 X 17		
254106	275 X 17		
17"			
251280	400/450 X 17		
	120/70 X 17		
	130/70 X 17		
18"			
251300	350 X 18		TR4
21"			
251305	2.75/3.00 X 21		
MINI / POCKET			
960126D	3.00 X 4	MINI-QUADER 50	
960906P	110/50 X 6.5	MINI-SCOOT 50	
960906Q	90/65 X 6.5	MINI-SCOOT 50	
251310	15 X 6	DURO	



TDH 2DAY

251373	2.50/2.75/3.00-10 RENF.		TR4
251374	3.00/3.25/3.50-12 (80/100-12) RENF.		TR4
251375	2.25/2.50/2.75-14 (60/100-14) RENF.		TR4
251372	2.00/2.25-19 (2-19 /2 ¼-19)		TR4
251379	2.75-19 (2 3/4-19)		TR4

PNEUMATIQUE PNEUMATICI ACCESSOIRES & REPARATION ACCESSORI & RIPARAZIONE

TNT
Original



KIT REPARATION TUBELESS
KIT RIPARAZIONE TUBELESS
255005



KIT REPAR TUBELESS A MECHE + CO2
KIT RIPARAZIONE TUBELESS + CO2
255005A + CARTOUCHES D'AIR COMPRI
+ CARTUCCE ARIA COMPRESSA



MECHES
255005B 50 PIECES PEZZI



BOITE REPARATION CREVAISON
KIT RIPARAZIONE FORATURA
255000 CYCLO MOPED



BOMBE ANTI-CREVAISON
BOMBOLETTA GONFIA E RIPARA
255010 100 ml (1)
255012 300 ml (2)



DEMONTE OBUS UNIVERSEL
SMONTA VALVOLA UNIVERSALE
255005F



REMA
TOP
TOP



MASSES AUTOCOLLANTES POUR ÉQUILIBRAGE
PESI ADESIVI PER EQUILIBRATURA
255005E 25 BARRETTES



BOMBE ANTI-CREVAISON
BOMBOLETTA GONFIA E RIPARA
S5160 200 ML
S5161 300 ML



BOITE REPARATION CREVAISON
KIT RIPARAZIONE FORATURA
S2410



BEAD SEALER
S240807 1 L



PATE A PNEU
PATE A PNEUMATICO
S593059 1 KG



SPECIAL CEMENT
MASTICE SPECIAL
S515934 POT 40 G (1)
S515004 TUBE (2)

* Adaptable
* Adattabile

Les références du constructeur sont seulement indicatives et n'impliquent pas que les pièces de rechange viennent du constructeur.
I codici di riferimento originali sono indicativi e non implicano che i ricambi provengano necessariamente dalla stessa fabbrica del costruttore.

PNEUMATIQUE PNEUMATICI

VALVE & BOUCHON VALVOLA & COPPIA TAPPI

TNT
Tuning



PAIRE BOUCHON VALVE OBUS
COPPIA TAPPI VALVOLE OBUS

252008 BLEU BLU

252008A ROUGE ROSSO



PAIRE BOUCHON VALVE SMILE
COPPIA TAPPI VALVOLE SMILE

252007 BLEU BLU



BOUCHON VALVE LED LIGHTER
TAPPO VALVOLA LED LIGHTER

252017 BLEU BLU



PAIRE BOUCHON VALVE PISTON
COPPIA TAPPI VALVOLE PISTONE

252000 CHROME CROMO

252000A BLANC BIANCO

252001 BLEU BLU

252003 OR ORO

252004 NOIR NERO

252005 ROUGE ROSSO

TNT
Original

TNT
Tuning



VALVE TUBELESS COUDÉE
VALVOLE TUBELESSE

255006 ALU ALLUMINIO

255007 BLEU BLU

255008 VIOLET VIOLA

255009 ROUGE ROSSO



VALVES TUBELESS COUDÉE
VALVOLE TUBELESSE

252003



VALVES TUBELESS STRAIGHT
VALVOLE TUBELESSE

252004

ACCESSOIRES ACCESSORI

TNT
Tuning



STYLO PNEU
PENNARELLO PNEUMATICI

259000 BLANC BIANCO

259001 BLEU BLU

259002 ROUGE ROSSO

259003 JAUNE GIALLO



MAINTENANCE

- > HUILE
- > PEINTURE

MANUTENZIONE

- > OLIO
- > VERNICE



STROKE 2R
RED BULL MOTO GP ROOKIES CUP
 100 % SYNTHÈSE
 S28152 1L



2T-SAMOURAI RACING
 100 % SYNTHÈSE
 S28480 1L
 S28480A 1L FRAISE FRAGOLA



2T-SCOOT RUN 2
 100 % SYNTHÈSE
 S28115 1L
 S28154 1L FRAISE FRAGOLA



2T-R2000
 SEMI-SYNTHÈSE
 S28350 1L
 S28153 1L FRAISE FRAGOLA



2T-SCOOT CITY
 SEMI-SYNTHÈSE
 S28125 1L
 S28155 1L FRAISE FRAGOLA
 S28125A 2L



SELF OIL
 SEMI-SYNTHÈSE
 S28156 1L
 S28157 1L FRAISE FRAGOLA
 S28140 60L (fût)



4T KATANA SCOOT 5W40

100 % SYNTHÈSE
 S28959A 2 L



4T SCOOT 4 10W30

SEMI-SYNTHÈSE
 S28131 1 L



4T-SCOOT 4 10W40

SEMI-SYNTHÈSE
 S28130 1 L



4T-R4000 RS 10W40

SEMI-SYNTHÈSE
 S28145 1 L
 S28106 4 L



4T R4000 RS 10W50

SEMI-SYNTHÈSE
 S28146 1 L



4T-ATV 4000

SEMI-SYNTHÈSE
 S28990 1 L



STROKE 4 5W40

RED BULL MOTO GP ROOKIES CUP

100 % SYNTHÈSE
 S28151 1 L
 S28150 4 L

* Adaptable
 * Adattabile

Les références du constructeur sont seulement indicatives et n'impliquent pas que les pièces de rechange viennent du constructeur.
 I codici di riferimento originali sono indicativi e non implicano che i ricambi provengano necessariamente dalla stessa fabbrica del costruttore.



BOX X-TREM
MOTO GP ROOKIES CUP
 HUILE BOITE 100% SYNTHÈSE
 OLIO SET 100% SYNTHÈSE
 S28916 1 L



BOX2 SYNTHÈSE
 HUILE BOITE
 OLIO SET
 S28283 1 L



TRANS'SCOOT
 HUILE BOITE
 OLIO SET
 S28304 DOSE 125 ML



TRANS 4
 HUILE BOITE/PONT
 OLIO SET
 S28280 80/90 1 L
 S28280A 80/140 1 L



FORK SYNTHETIC
 HUILE DE FOURCHE
 OLIO FORCELLA
 S28281 5 1 L



XTREM CHAIN ROAD
 HUILE DE CHAIN
 OLIO CATENA
 S28751 250 ML
 S28751A 750 ML



DOT 5.1
 HUILE DE FREIN 100% SYNTH.
 OLIO FRENI
 S1901A 500 ML



DOT 4
 HUILE DE FREIN
 OLIO FRENI
 S1901 250 ML



FILTER OIL
 HUILE DE FILTRE
 OLIO FILTRO
 S28757 500 ML



RADIATOR
 LIQUIDE DE REFROIDISSEMENT
 LIQUIDO REFRIGERANTE

S39145 1 L



SPRAY CARBU CLEANER
 NETTOYANT
 PULITO

S28755 750 ML



SPRAY AIR FILTER OIL
 NETTOYANT
 PULITO

S28758 750 ML



AIR FILTER
 NETTOYANT
 PULITO

S28756 5 L



ABSOLUT WASH
 LIQUIDE DE LAVAGE FONTAINE
 LIQUIDO DI LAVAGGIO

S283807 58 L



DOSEUR D'HUILE
 CONTEGGIO OLIO

S47100 500 ML



DOSEUR GRADUE IPONE
 CONTEGGIO OLIO IPONE

S47100A 2 L



DOSEUR GRADUE IPONE
 CONTEGGIO OLIO IPONE

S47100B 5 L

MAINTENANCE MANUTENZIONE
HUILE 2 TEMPS OLIO 2T



2T KART-2
 100% SYNTHÈSE
 621110 1L



2T SCOOTER OIL
 SYNTHÈSE
 621113 1L
 621113A 50L



2T MOPED OIL
 SYNTHÈSE
 621112 DOSETTE 125ML



2T UNIVERSAL
 MINÉRALE
 621114 1L

HUILE 4 TEMPS OLIO 4T



4T GLOBAL SPIRIT
 20W50
 621108B 50L



ROBINET POUR FUT GRO
RUBINETTO
 621121B

MAINTENANCE MANUTENZIONE
HUILE 4 TEMPS OLIO 4T



4T GLOBAL RACING

100% SYNTHÈSE 5W40

621100 1L

621100A 50L



4T GLOBAL RACING

100% SYNTHÈSE 10W30

621101 1L

621101A 4L



4T GLOBAL RACING

100% SYNTHÈSE 10W50

621102 1L

621102A 4L

621102B 50L



4T GLOBAL SCOOTER

100% SYNTHÈSE 5W40

621103 1L

621103A 50L



4T GLOBAL SMART

SYNTHÈSE 10W40

621104 1L

621104A 4L

621104B 50L



4T GLOBAL SMART

SYNTHÈSE 15W50

621105 1L

621105A 4L



4T GLOBAL SCOOTER

SYNTHÈSE 10W40

621106 1L

621106A 50L



4T UNIVERSAL

MULTIGRADE 15W40

621107 1L

621107A 50L

* Adaptable
 * Adattabile

Les références du constructeur sont seulement indicatives et n'impliquent pas que les pièces de rechange viennent du constructeur.
 I codici di riferimento originali sono indicativi e non implicano che i ricambi provengano necessariamente dalla stessa fabbrica del costruttore.



GEAR EXTREM 75W

HUILE DE BOITE
 OLIO SET

621115 1L



GEAR TRANS 10W40

HUILE DE BOITE
 OLIO SET

621116 10W40 1L

621117 85W140 1L



LONGTIME GCC-30Z

LIQUIDE DE REFROIDISSEMENT
 LIQUIDO REFRIGERANTE

621118 1L

621119 5L



FORK FLUID

HUILE DE FOURCHE 1L
 OLIO FORCELLA 1L

621123 2,5W

621123A 5W

621123B 7,5W

621123C 10W

621123D 15W

621123E 20W



GEAR TRANS

HUILE DE TRANSMISSION
 OLIO DI TRASMISSIONE

621121A 80W90 (1L)



MOTOSIERRAS

HUILE CHAINE TRONÇONEUSE
 OLIO CATENA MOTOSEGA

621122 SAE30 (5L)



DOT-4

LIQUIDE DE FREIN
 OLIO FRENI

621121C 500 ml



DOT-5.1

LIQUIDE DE FREIN
 OLIO FRENI

621121 500 ml



COGELSA ULTRAPASTE

GRASSE CUIVRE CU 25
 GRASSO RAME CU 25

621120 1L



DISPLAY

PRESENTOIR GLOBAL RACING OIL

621120A LIVRÉ VIDE VENDUTE VUOTE



MOTO 2T - MOTO 4T
MOTO GEARBOX - MOTO CARE



**PUISSANCE MAXIMALE
POUR TON MOTEUR**



GLOBALRACINGOIL.COM



GRAISSE CHAÎNE TOUT TERRAIN
 OLIO CATENA OFF ROAD
 S202141 AEROSOL 500 ML



GRAISSE CHAÎNE
 OLIO CATENA
 S202140 AEROSOL 250 ML
 S202157 AEROSOL 750 ML

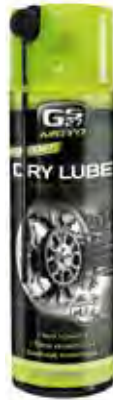

LUBRIFIANT CHAÎNE PTFE
 OLIO CATENA PTFE
 S202147 500 ML



HUILE FILTRE À AIR
 OLIO FILTRO ARIA
 S202162 AEROSOL 750 ML



DEGRAISSE CHAÎNE
 PULITO CATENA
 S202160 AEROSOL 750 ML

N



NETTOYANT CARBURATEUR
 PULITO CARBURATORE
 S202161 AEROSOL 750 ML

N



NETTOYANT JANTES TITANIUM
 PULITO CERCHIO TITANIUM
 S202135 SPRAY 500 ML



LAVAGE & BRILLANCE EXPRESS
 PULITO & BRILLO EXPRESS
 S202133 SPRAY 500 ML



NETTOYANT INSECTES & FIENTES
 IPULITO INSETTI
 S202134 SPRAY 500 ML



LINGETTES ULTRA DÉGRAISSANTES
 SALVIETTE ULTRA SGRASSANTI
 S202163 PACK 35

N



NETTOYANT CASQUE
 PULITO CASCHI
 S202136 AEROSOL 250 ML



ASSAINISSANT CASQUE, BOTTES,...
 ODORE DISTRUTTORE
 S202139 AEROSOL 250 ML



ANTI BUÉE
 ANTI NEBBIA
 S202149 AEROSOL 250 ML



ANTI PLUIE
 ANTIPIOGGIA
 S202138 AEROSOL 250 ML



RENOVATEUR PNEUS
 RINNOVATO PNEUMATICI
 S202143A AEROSOL 400 ML



EFFACE RAYURES TITANIUM
 RIPARA GRAFFI
 S202144 150 G



RENOVATEUR ALU & CHROM
 RINNOVATO ALLU & CROM.
 S202143 150 G



LUSTREUR TITANIUM
 LUCIDATURA TITANIUM
 S202142 400 ML



BAUME CUIR
 CREMA PELLE
 S202145 400 ML



REPARATION CREVAISON
 ANTIFORATURA
 S202137 AEROSOL 300 ML

NOUVEAU!

**GS
27
MOTO**

**GS27 PRESENTE SA
NOUVELLE GAMME
100% MOTARD!**



16 PRODUITS HAUTE PERFORMANCE



Des produits pour l'entretien technique de votre moto :
Graisse Chaîne Route et Tout Terrain, Dégraissant Chaîne, Frein & Disques, etc.



Des produits pour laver et faire briller votre moto :
Nettoyant Jantes, Lavage & Brillance Express, Rénovateur Alu & Chromes, etc.



Des produits spécifiques à l'entretien de tout l'équipement du motard :
Nettoyant Casque Extérieur, Assainissant Casque, Bottes & Gants, Baume Cuir, etc.



**UNE GAMME COMPLETE
RÉPONDANT A TOUS LES
BESOINS DES MOTARDS**

GS27
25 Rue de la Flottière - ZAC de la Liodière - CS90415
37304 Joué-lès-Tours Cedex - France - www.gs27.com

uoodoo ride



NETTOYANT ANTIBACTERIEN
 PULITO BATTERICIDA
 S202202 750 ML



NETTOYANT JANTES PNEUS
 PULITO CERCHIONI PNEUMATICI
 S202200 750 ML



SHAMPOING ULTRA GLOSS
 PULITO ULTRA GLOSS
 S202203 500 ML



POLISH RENOVATEUR LUSTRANT
 RINNOVATORE CHE LUSTRA
 S202207 500 ML



EFFACE RAYURES
 CANCELLA RIGHE
 S202201 150G



CIRE DE FINITION
 CERA DI RIFINITURA
 S202206 400ML



RENOVATEUR TOUS METAUX
 RINNOVATORE OGNI METALLO
 S202205 150G



BRILLANT PNEU
 BRILLANDO PNEUMATICO
 S202204 400ML



N

LINGETTES
 SALVIETTE
 S202215



GANT DE LAVAGE
 GUANTO DI LAVAGGIO
 S202209 A L'UNITÉ
 S202213 CROSS MERCH PAR 5



MICROFIBRE
 MICROFIBRE
 S202208 A L'UNITÉ
 S202212 CROSS MERCH PAR 5



PRESENTOIR STARTER
 DISPLAY STARTER
 S202211



PRESENTOIR AVEC ECRAN
 DISPLAY CON MONITOR
 S202210

NOUVEAU

**woodoo
ride®**

⚠ DANGER

**UN EXCÈS DE BRILLANCE
PEUT CAUSER
JALOUSIE ET ENVIE**





DISPLAY WD-40
 S202108 24 SPRAY 100 ML



WD-40
 S800020 SPRAY 100 ML
 S51400 SPRAY 200 ML



NETTOYANT CONTACTS
 PULITO CONTATTI
 S33009A 400 ML



3 EN 1
 S33009 SPRAY 250 ML



WD-40
 S51452 5 L



PULVERISATEUR WD-40
 S51452A 500 ML (VIDE)



LUBRIFIANT REFROIDISSEUR
 LIQUIDO REFRIGERANTE
 S5839A -30° AEROSOL 400 ML



NETTOYANT FREIN PRESTO
 PULITO FRENI
 5839 AEROSOL 600 ML



QUATOR METAL POLISH
 S202132 75 G

MAINTENANCE MANUTENZIONE

PEINTURE VERNICE



PEINTURE GLYCERO AEROSOL 400 ML
 510000 BLANC BRILLANT BIANCO BRILLAN
 510030 NOIR BRILLANT NERO BRILLANTE
 510032 NOIR MAR NERO OPACO

VERNICE GLICEROFTALICHE 400 ML
 510033 NOIR SATINE NERO SATINE
 S424011 GRIS BRILLANT GRIGIO BRILLANTE

510037 BLEU METAL BLU METAL
 510038 ROUGE METAL ROSSO METAL
 510039 GRIS METAL GRIGIO METAL

510044 ARGENT ARGENTO
 510045 VERT DERBI VERDE DERBI
 510241 ROUGE SIGNAL ROSSO SIGNAL



PEINTURE GLYCERO AEROSOL 400 ML
 S424009 JAUNE GIALLO
 S424008 ORANGE ARANCIONE
 S424012 ROUGE RUBIS BRILLANT ROSSO

VERNICE GLICEROFTALICHE 400 ML
 S424006 VERT FEUILLE VERDE
 S424010 BLEU BRILLANT BLU BRILLANTE



FLUO

PEINTURE ACRYLIQUE AEROSOL 400 ML
 S424018 NOIR METAL NERO METAL
 S424019 VIOLET METAL VIOLA METAL
 S424015 ROUGE METAL ROSSO METAL

VERNICE ACRILICO 400 ML
 510310 EFFET CHROME EFFETTO CROMO

PEINTURE ACRYLIQUE AEROSOL 400 ML
 510001 ROSE ROSA
 510001A JAUNE GIALLO
 510001B VERT VERDE

VERNICE ACRILICO 400 ML
 510001C ORANGE ARANCIONE



650°



650°



APPRET AEROSOL 400 ML
APPRETTO SPRAY 400 ML
 510300 GRIS GRIGIO

APPRET AEROSOL 400 ML
APPRETTO SPRAY 400 ML
 S511611 BLANC BIANCO

PEINTURE HAUTE T° 400 ML
VERNICE ALTA T° 400 ML
 510304 NOIR NERO

VERNIS
VERNICE
 510305 400 ML HAUTE TEMP.
 510306 500 ML TRANSP.

PEINTURE AEROSOL 400 ML
VERNICE 400 ML
 S790652 3D

LISERET LINER



LISERET DE JANTE 10M X 6MM
LINER DE CERCHIO 10M X 6MM
 500322 BLEU FONCÉ BLU
 500322A VERT CLAIR VERDE
 500322B JAUNE GIALLO
 500322C ROUGE ROSSO
 500322D BLANC BIANCO
 500322E NOIR NERO
 500322F OR ORO

* Adaptable
 * Adattabile

Les références du constructeur sont seulement indicatives et n'impliquent pas que les pièces de rechange viennent du constructeur.
 I codici di riferimento originali sono indicativi e non implicano che i ricambi provengano necessariamente dalla stessa fabbrica del costruttore.

ANTIVOL MOTO

homologué

**CLASSE
S.R.A.**

- Anse en acier trempé de 18 mm de diamètre
- Mécanisme de verrouillage blindé 5 mm d'épaisseur
- Double mécanisme de verrouillage par cames en acier
- Serrure tubulaire de sécurité à 7 pins
- Anti-sciage, anti-crochetage
- Dispositif anti-giratoire de la anse en cas de coupure
- Bloc de verrouillage en acier cimenté
- Cache de protection contre l'humidité
- Service de copie de clé par code exclusif

Disponible en 2 dimensions :
Réf. 603034 - 85 x 100
Réf. 603031 - 85 x 250

LOCK FORCE



ANTIVOL
> ANTIVOL

ANTIFURTO
> ANTIFURTO



F5

603034	85 X 100 CM	(1)
603031	85 X 250 CM	
603033	85 X 310 CM	

**CLASSE
S.R.A.**



(1)

F5

- Anse en acier trempé de 18 mm de diamètre
- Serrure tubulaire de sécurité à 7 pins
- Anti-sciage, anti-crochetage
- Cache de protection contre l'humidité
- Service de copie de clé par code exclusif

- Archetto da 18 mm di diametro in acciaio temprato
- Serratura tubolare di sicurezza a 7 pin
- Anti-taglio, anti-scasso,
- Sistema di protezione contro l'umidità
- Servizio di copia chiave per codice esclusivo



LOKNESS

ANTIVOL DE CASQUE
ANTIFURTO DI CASCHI
603002



STEELCABLE

603045	10 MM X 2 M
603045A	10 MM X 9 M



BOA

603018	120 CM Ø10
603019	150 CM Ø10
603020	180 CM Ø10

BOA

- Section carrée trempée haute résistance
- Gaine en nylon assurant protection aux chocs et aux rayures
- Clés de précision haute sécurité
- Maillon 10 mm de diamètre

- Sezione maglia quadra temprata ad alta resistenza
- Guaina in nylon antiurto ed antigraffio
- Chiavi di precisione alta sicurezza
- Archetto da 10 mm di diametro



ANACONDA

603023	100 CM Ø10
603025	150 CM Ø10
603026	180 CM Ø10

ANACONDA

- Chaîne en acier cémenté de 10 mm de diamètre
- Cadenas intégré
- Clés sécurités
- Cache de protection contre l'humidité

- Catena in acciaio cementato di 10 mm di diametro
- Lucchetto integrato
- Chiavi di precisione alta sicurezza
- Sistema di protezione contro l'umidità



GOLIATH

603037A 55 X 55 MM



HERCULE

603030A 320 MM X 165 MM
 603030 240 MM X 165 MM



ARTICULE

601225 Ø22 X 1000 MM
 601226 Ø22 X 1200 MM
 601227 Ø22 X 1500 MM



BLOC DISQUE ALARME
BLOCCA DISCO ALARME INTERNO

603042 INOX
 603042A CROMO (1)



BLOC DISQUE ALARME ON/OFF
BLOCCA DISCO ALARME ON/OFF

603043 INTELLIGENT



BLOC «WHEEL»

603038 MINI - Ø5,5 MM
 603039 MEDIA - Ø8 MM
 603040 STRONG - Ø10 MM (1)



FLIBUSTIER

603037 Ø11 MM



CABLE ANTI-OUBLI

603044 COURT CORTO (SCOOTER)
 603044A LONG LUNGO (MAXI SCOOTER)



PILE DE RECHANGE
BATTERIA DI RICAMBIO

603042B LR44

* Adaptable
 * Adattabile

Les références du constructeur sont seulement indicatives et n'impliquent pas que les pièces de rechange viennent du constructeur.
 I codici di riferimento originali sono indicativi e non implicano che i ricambi provengano necessariamente dalla stessa fabbrica del costruttore.



CROMA R

603070	95 X 250
603070A	150 X 310



ESCUDO CHAIN H

603070C	110 CM
603070J	140 CM



ESCUDO CHAIN PLUS

603070G	120 CM
---------	--------

EQUIPEMENT PILOTE

- > GANT
- > CASQUES
- > MASQUES
- > VETEMENT DE PLUIE
- > CAGOLE

ABBIGLIAMENTO MOTO

- > GUANTI
- > CASCHI
- > MASCHERE
- > ANTIPIOGGIA
- > SOTTOCASCO

> GLOBE

N



Le gant universel avec coques de protection.

Le Globe n'a d'autre prétention que d'apporter le minimum de protection indispensable à la pratique de toute activité deux roues (moto, scooter, vélo). Son dénuement le rend agréable à porter et il est rapidement devenu le gant basique universel de référence. Il se décline en noir pour les plus classiques d'entre nous, et en versions graphiques Globe Replica pour les plus audacieux. Léger tout en intégrant des coques de protection PU sur le dessus de la main et dans la paume, il offre un compromis satisfaisant entre agrément et sécurité. Un gant simple, pratique, et très abordable.

- Homologué EN 13594:2015

Il guanto universale con inserti protettivi.

Il Globe non ha altra pretesa se non quella di fornire la minima protezione necessaria alla pratica di qualsiasi attività a due ruote (moto, scooter, bici). La sua naturale ergonomia lo rende comodo da indossare e rapidamente è diventato il guanto di riferimento europeo. In nero per il più classico e nelle versioni grafiche Globe Replica per i più audaci. Leggero ed al tempo stesso incorpora gusci di protezioni in PU sulla parte superiore della mano e sul palmo, offre un compromesso soddisfacente tra piacere e sicurezza. Un semplice guanto, pratico e molto conveniente.



GLOBE	
NOIR NERO	
XS	447908
S	447908A
M	447908B
L	447908C
XL	447908D
XXL	447908E



EN 13594:2015



GLOBE REPLICARACER	
BLACK	
XS	447915
S	447915A
M	447915B
L	447915C
XL	447915D
XXL	447915E



EN 13594:2015



> GLOBE

NEW



FLUO YELLOW



FLUO RED

GLOBE REPLICA CAMO

	FLUO GREEN	FLUO YELLOW	FLUO RED
XS	447914	447912	447913
S	447914A	447912A	447913A
M	447914B	447912B	447913B
L	447914C	447912C	447913C
XL	447914D	447912D	447913D
XXL	447914E	447912E	447913E



EN 13594:2015

> TEXAS

NEW



BROWN/WHITE



WHITE/BLUE

Culture custom, misez sur le 5.

L'esthétique vintage et son numéro 5 ne sont pas sans évoquer la compétition d'antan, à une époque où le cuir ornait l'équipement des pilotes de la tête aux pieds. Son cuir ultrasouple procure un agrément d'utilisation exceptionnel. Il est doté d'une fermeture zip pour faciliter l'enfilage et s'ajuste à l'aide d'une patte de cuir située sous le poignet. Les perforations des doigts, du dessus de la main et du pouce sont là pour l'esthétique mais également pour la ventilation.

Cultura custom, scommetti sul 5.

L'estetica vintage e il suo numero 5 ricordano la competizione dei tempi passati, in un periodo in cui la pelle adorna l'equipaggiamento dei piloti dalla testa ai piedi. La sua pelle ultra morbida offre un'esperienza di utilizzo eccezionale. Ha una chiusura a zip per indossarsi facilmente e si adatta con una linguetta di cuoio sotto il polso. Le perforazioni delle dita, la parte superiore della mano e il pollice sono lì per l'estetica ma anche per la ventilazione.

CALIFORNIA

	BROWN/WHITE	WHITE/BLUE
XS	447953	447954
S	447953A	447954A
M	447953B	447954B
L	447953C	447954C
XL	447953D	447954D
XXL	447953E	447954E



EN 13594:2015

* Adaptable
* Adattabile

Les références du constructeur sont seulement indicatives et n'impliquent pas que les pièces de rechange viennent du constructeur.
I codici di riferimento originali sono indicativi e non implicano che i ricambi provengano necessariamente dalla stessa fabbrica del costruttore.

> MUSTANG

NEW



BLACK



Simplicité à l'état pur – Ultra-court.

Ce gant surprend par son esthétique minimaliste et son aspect ultra-compact, en raison d'un poignet des plus courts. Le cuir perforé dont est constituée sa zone supérieure, sans couture ni empiècement additionnel, participe à la sobriété et au classicisme de l'ensemble. Bien qu'extrêmement élégant, doté d'une coque sous cuir, le Mustang saura se montrer protecteur. Son poignet court intègre un soufflet d'aisance en Lycra pour un excellent maintien et une totale liberté de mouvement. Équipé de ce gant, on se sent donc libre... comme un Mustang.

Semplicità allo stato puro - Ultra-corto.

Questo guanto sorprende con la sua estetica minimalista e il suo aspetto ultra-compacto, grazie al polso corto. La pelle perforata di cui è costituita la zona superiore, senza cucitura o inserto aggiuntivo, partecipa alla sobrietà e al classicismo al tempo stesso. Sebbene estremamente elegante, con protezioni di pelle, il Mustang è protettivo. Il polso corto incorpora un tassello in Lycra per un eccellente sostegno e completa la libertà di movimento. Con questo guanto, ci si sente liberi ... come un Mustang.



CE

EN 13594:2015

MUSTANG

BLACK
447955 XS
447955A S
447955B M
447955C L
447955D XL
447955E XXL

> CALIFORNIA

NEW



BLACK/WHITE



BLACK



BROWN



Pour les hommes de caractère.

Ce gant tout cuir en impose grâce à ses coutures transversales et à son aspect matelassé que l'on retrouve habituellement sur les selles des plus belles machines custom. La large patte d'ajustement en cuir qui se ferme par le dessus du poignet rompt avec la tradition et renforce l'esthétique plutôt virile du California. Le renfort de paume en cuir qui se prolonge en languette visant à faciliter l'enfilage témoigne de notre volonté de conjuguer esthétique et fonctionnalité. Un gant de caractère pour hommes (et motos) de caractère.

Per uomini di carattere.

Questo guanto tutto il cuoio si impone grazie alle sue cuciture trasversali ed al suo aspetto trapuntato che vediamo di solito sulle selle delle più belle moto custom. L'ampia appendice in pelle che si chiude nella parte superiore del polso rompe con la tradizione e rafforza l'estetica piuttosto virile del California. Il rinforzo del palmo in pelle che si estende nella chiusura per facilitare la vestizione, testimonia il nostro desiderio di coniugare estetica e funzionalità. Un guanto di carattere per uomini (e motociclette) di carattere.

CALIFORNIA

	BLACK	BLACK/WHITE	BROWN
XS	447950	447951	447952
S	447950A	447951A	447952A
M	447950B	447951B	447952B
L	447950C	447951C	447952C
XL	447950D	447951D	447952D
XXL	447950E	447951E	447952E



CE

EN 13594:2015

➤ **STUNT EVO**



BLACK



BLACK/WHITE



BLACK/RED

Évolution de l'espèce.

Concept de gant inventé par FIVE et destiné à un usage urbain et péri-urbain engagé, souvent copié mais jamais égalé, le STUNT était considéré, à juste titre, comme l'original du genre. Il a évolué pour devenir STUNT EVO avec un nouveau design et de nouvelles coques de protection, ainsi qu'une nouvelle protection de paume en carbone. Caractérisé par sa paume en cuir, son fitting, son confort et ses sensations des commandes s'avèrent exceptionnelles grâce à sa structure supérieure extensible.



EN 13594:2015

STUNT EVO			
	BLACK	BLACK/WHITE	BLACK/RED
XS	447903	447904	447907
S	447903A	447904A	447907A
M	447903B	447904B	447907B
L	447903C	447904C	447907C
XL	447903D	447904D	447907D
XXL	447903E	447904E	447907E

➤ **STUNT EVO LITE**



L'essentiel du Stunt Original, à moindre coût.

Modèle visant à rendre très accessible ce concept de gant urbain à succès. Il reprend l'esthétique si caractéristique du STUNT, qui s'est imposé pendant 10 ans comme la référence du genre. La sécurité n'est pas en reste avec ses coques de phalanges héritées du modèle d'origine et une coque de paume en PU. Il conserve l'essentiel de l'esprit STUNT dans un prix très contenu.



EN 13594:2015

STUNT EVO LITE	
	BLACK
XS	447902
S	447902A
M	447902B
L	447902C
XL	447902D
XXL	447902E
XXXL	447902F

* Adaptable
 * Adattabile

Les références du constructeur sont seulement indicatives et n'impliquent pas que les pièces de rechange viennent du constructeur.
 I codici di riferimento originali sono indicativi e non implicano che i ricambi provengano necessariamente dalla stessa fabbrica del costruttore.

PLANET



- **Dessus** : Tissu synthétique et fourchettes en lycra
- **Paume** : Clarino, manchette en néoprène
- **Patte de serrage** poignet en TPR

- **Dorso** : Tessuto sintetico con fascia in lycra
- **Palmo** : Clarino con polsino in neoprene
- **Fascia** per regolazione polso in TPR



BRAZIL



CORSICA



ENGLAND



ITALIA



JAPAN



USA

PLANET PATRIOT

	BRAZIL	CORSICA	ENGLAND	ITALIA	JAPAN	USA
XS	-	-	447872A	447873A	-	447875A
S	447870B	447871B	447872B	447873B	-	447875B
M	447870C	447871C	447872C	447873C	-	447875C
L	447870D	447871D	447872D	447873D	447874D	447875D
XL	447870E	-	447872E	447873E	447874E	447875E
XXL	-	-	-	447873F	-	447875F



USA KID



FLAMING

PLANET PATRIOT

S	447911
M	447911A
L	447911B
XL	447911C

PLANET FASHION

S	447876B
M	447876C
L	447876D
XL	447876E



LOGO BLUE



LOGO ORANGE

PLANET LOGO

	LOGO BLUE	LOGO ORANGE
XS	447887A	447888A
S	447887B	447888B
M	447887C	447888C
L	-	447888D
XL	447887E	447888E
XXL	447887F	447888F
XXXL	447887G	447888G

PROTECTION / FITTING / DESIGN



GLOBE BLACK



GLOBE BLACK

GANTS CERTIFIÉS



FIVE GLOBE



GLOBE CAMO FLUO RED



GLOBE CAMO FLUO YELLOW



GLOBE CAMO FLUO GREEN



GLOBE RACER



ENJOY
THE
CITY.
RIDE
THE
GLOBE!*

***Profitez de la ville. Roulez en Globe !** Le gant universel par excellence selon FIVE : certifié CE, il répond à l'obligation de porter des gants homologués. Léger, tout en intégrant des coques de protection PU sur le dessus de la main et dans la paume, il offre la protection indispensable à la pratique de toute activité deux roues (moto, scooter, vélo) et représente le bon compromis pour affronter la circulation urbaine. Globe bénéficie de tout le soin apporté à la conception et à la fabrication des gants FIVE. En spécialiste du gant, nous équipons les pilotes les plus exigeants, en championnats du monde MotoGP, Superbike, Endurance et Motocross, comme à la ville ! Voici le plus accessible des FIVE ADVANCED GLOVES. Globe. Du XS au XXL. À découvrir et essayer chez votre revendeur.

> ICE



Hiver

Le gant hiver entrée de gamme, accessible et efficace!

Membrane étanche respirante Hipora®.

Doublure Thinsulate 180g.

Ajustement de la manchette par velcro.

Gant confortable pour un utilisateur qui privilégie le budget sans négliger la qualité et l'efficacité, et qui recherche un gant chaud et étanche en usage urbain et péri-urbain.

Invernali

I guanti invernali di entrata gamma accessibili ed efficaci!

Membrana impermeabile e respirante Hipora®.

Doppio tessuto 180 g.

regolazione polso tramite velcro.

Guanti confortevoli per l'utilizzazione di chi privilegia il prezzo senza trascurare qualità ed efficacia, per chi ricerca un guanto caldo ed impermeabile nell'utilizzo urbano ed extra-urbano.



ICE
WATERPROOF

NOIR NERO
447921A XS
447921B S
447921C M
447921D L
447921E XL
447921F XXL
447921G XXXL

> BLIZZARD



Hiver

Le gant hiver accessible et universel à l'esthétique très typée moto!

Structure textile avec coque de protection des phalanges et de paume en PU.

Membrane étanche respirante Hipora®. Doublure Thinsulate® 180g pour l'isolation thermique.

Fourrure synthétique à l'intérieur du manchon pour protéger du froid et accroître la sensation de confort. Soufflets d'aisance aux doigts et pouces. Large patte d'ajustement de la manchette par velcro.

Homologation CE, EN 13594/2015

Invernali

I guanti invernali accessibili ed universali con un'estetica motociclistica!

Struttura tessile con protezione falangi e palmo in PU.

Membrana impermeabile traspirante Hipora®.

Doppia Densità® 180 g per isolamento termico.

Cuciture rosse rinforzate.

Pelo sintetico interno polso per proteggere dal freddo ed aumentare la sensazione del confort. Sistema soffiato di ritorno allieva dita e pollice. Ampia base di regolazione per il polso tramite velcro.

Guanti per utilizzo extra-urbano



BLIZZARD
WATERPROOF

NOIR NERO
447920A XS
447920B S
447920C M
447920D L
447920E XL
447920F XXL
447920G XXXL



> SMX



Hiver

Le gant urbain multi-fonctions.

Destiné à ceux qui recherchent un gant fonctionnel et économique offrant un bon niveau de protection.

Ajustement de la manchette par velcro.

Protection monocoque sur le dessus de la main.

Protection de la paume.

Homologation CE, EN 13594/2015

Inverno

Il guanto urbano multi-funzione.

Destinato a chi ricerca un guanto funzionale ed economico ma avente un buono livello di protezione.

Regolazione del polsino tramite velcro.

Protezione nocchie con monoscocca superiore.

Protezione del palmo.

Omologato CE secondo la norma EN 13594



SMX
COQUES

NOIR NERO
447922A XS
447922B S
447922C M
447922D L
447922E XL
447922F XXL



> 4 SEASONS



Mi-Saison/Hiver

- **Dessus** : Tissu synthétique et fourchettes en lycra, Coque de protection
- **Paume** : AMARA, Slider de protection PU
- **Doublure** : waterproof, membrane Hipora
- **Homologation** CE, EN 13594/2015

Mezza-Stagione/Inverno

- **Dorso** : Tessuto sintetico e forcelle in lycra, Guscio di protezione
- **Palmo** : AMARA, protezione di scorrimento PU
- **Fodera** : impermeabile, membrana Hipora
- Omologato CE

**4 SEASONS
 WATERPROOF**

NOIR NERO
 447892A XS
 447892B S
 447892C M
 447892D L
 447892E XL
 447892F XXL
 447892G XXXL



> ALL WEATHER



Mi-Saison/Hiver

- **Dessus** : Tissu synthétique et fourchettes en lycra
- **Paume** : AMARA microperforé
- **Doublure** : waterproof, membrane Hipora

Mezza-Stagione/Inverno

- **Dorso** : Tessuto sintetico e forcelle in lycra
- **Palmo** : AMARA micro-perforata
- **Fodera** : impermeabile, membrana Hipora

ALL WEATHER

NOIR NERO
 447893A XS
 447893B S
 447893C M
 447893D L
 447893E XL
 447893F XXL
 447893G XXXL



> FLUO



Mi-Saison/Hiver

- **Dessus** : Tissu synthétique et fourchettes en lycra
- **Paume** : AMARA microperforé
- **Doublure** : waterproof, membrane Hipora

Mezza-Stagione/Inverno

- **Dorso** : Tessuto sintetico e forcelle in lycra
- **Palmo** : AMARA micro-perforata
- **Fodera** : impermeabile, membrana Hipora

FLUO

NOIR NERO
 447894B S
 447894C M
 447894D L
 447894G XXXL



➤ **TRIBUTE**

NOEND



N
NEW

FLUOR BLACK

- Calotte ABS polycarbonate
- 3 tailles de calotte XS, S/M et L/XL
- Intérieur look cuir et tissus
- Boucle micrométrique
- Accroche lunettes

- Calotta ABS polycarbonato
- 3 taglie di calotta XS, S/M, L/XL
- Interni look pelle e tessuto
- Chiusura micrometrica
- Aggancio mascherina



	XS	S	M	L	XL
SOLID					
WHITE	441950	441950A	441950B	441950C	441950D
BLACK	441951	441951A	441951B	441951C	441951D
MAT					
BLACK	441952	441952A	441952B	441952C	441952D
GREY	441953	441953A	441953B	441953C	441953D
GLITTER					
WHITE	441954	441954A	441954B	441954C	441954D
BLACK	441955	441955A	441955B	441955C	441955D
FLUOR					
WHITE	441956	441956A	441956B	441956C	441956D
BLACK	441957	441957A	441957B	441957C	441957D
STAR					
BLACK	441958	441958A	441958B	441958C	441958D
ARCHIVE					
BLACK	441970	441970A	441970B	441970C	441970D
BLUE	441971	441971A	441971B	441971C	441971D
GREEN	441972	441972A	441972B	441972C	441972D

ACCESSOIRES ACCESSORI

441950X	CASQUETTE BRILLANTE VISIERA BRILLANTE
441950Y	CASQUETTE MATE VISIERA OPACA
441950Z	ECRAN PLAT TRANSPARENT VISIERA INCOLORE

> **TRIBUTE**

NOEND



N
NEW

FLUOR WHITE



N
NEW

GLITTER BLACK



N
NEW

SOLID BLACK



N
NEW

MAT BLACK



N
NEW

STAR BLACK



N
NEW

GLITTER WHITE



N
NEW

SOLID WHITE



N
NEW

MAT GREY

> **ARCHIVE**

NOEND



N
NEW

ARCHIVE BLACK



N
NEW

ARCHIVE BLUE



N
NEW

ARCHIVE GREEN

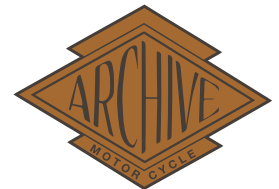

* Adaptable
* Adattabile

Les références du constructeur sont seulement indicatives et n'impliquent pas que les pièces de rechange viennent du constructeur.
I codici di riferimento originali sono indicativi e non implicano che i ricambi provengano necessariamente dalla stessa fabbrica del costruttore.

➤ **AERO**

TNT
Helmets



TNT
Helmets

NORMES ECE 22-05

- Coque en polycarbonate
 - Calotte en EPS
 - Tissu hypoallergénique, démontable et lavable
 - Ecran sphérique
 - Jugulaire à boucle rapide et a réglages micrométriques
- Calotta in polycarbonato
 - Interno Calotta in EPS
 - Tessuto ipoallergico ed estraibile
 - Visiera sferica antigraffio
 - Chiusura sottocollo a gancio rapido



3



4



7

	BRILLANT BRILLANTE	XS	S	M	L	XL	XXL
1	APNR	441881	441881A	441881B	441881C	441881D	441881E
2	ITALIA	441880	441880A	441880B	441880C	441880D	441880E
3	BLANC/NOIR BIANCO/NERO (liner NOIR NERO)	441837L	441837M	441837N	441837O	441837P	441837Q
4	NOIR NERO (liner NOIR NERO)	441725	441725A	441725B	441725C	441725D	441725E
	MAT OPACO						
5	REFLEX BLUE	441882	441882A	441882B	441882C	441882D	441882E
6	REFLEX ORANGE	441883	441883A	441883B	441883C	441883D	441883E
7	NOIR NERO (liner BLEU BLU)	441725F	441725G	441725H	441725I	441725J	441725K

➤ **ACCESSOIRES - ACCESSORI**

TNT
Helmets



FIXATION
FISSAGGIO

441726Z NOIR NERO
441727Y BLANC BIANCO



ECRAN INCOLORE
VISIERA INCOLORE

441880Z BLANC BIANCO



ECRAN INCOLORE
VISIERA INCOLORE

441880W NOIR NERO



ECRAN FUMÉ
VISIERA SOLAIRE

441837Y

> AERO



APNR



1

ITALIA



2

REFLEX BLUE



5

REFLEX ORANGE



6

* Adaptable
* Adattabile

Les références du constructeur sont seulement indicatives et n'impliquent pas que les pièces de rechange viennent du constructeur.
I codici di riferimento originali sono indicativi e non implicano che i ricambi provengano necessariamente dalla stessa fabbrica del costruttore.

➤ PUCK

TNT
Helmets



TNT
Helmets

NORMES ECE 22-05

- Coque en polycarbonate
 - Calotte en EPS
 - Tissu hypoallergénique, démontable et lavable
 - Ecran sphérique anti rayures avec contour finition sky
 - Jugulaire à boucle rapide et à réglages micrométriques
- Calotta in polycarbonato
 - Interno Calotta in EPS
 - Interneco pelle ipoallergico ed estraibile
 - Visiera sferica antigraffio
 - Chiusura sottocollo a gancio rapido



BRILLANT BRILLANTE	XS	S	M	L	XL
CAFE RACER ITALIA			441729C	441729D	
CAFE RACER UNION JACK		441730B	441730C	441730D	
ITALIA BLACK	441727A	441727B	441727C	441727D	441727E

➤ ACCESSOIRES - ACCESSORI

TNT
Helmets



FIXATION
FISSAGGIO

441723S VIS SCREW
441725Y KIT FIX. FIX. SET



ECRAN INCOLORE
VISIERA INCOLORE

441725T Ø18
441725Z Ø30



ECRAN FUMÉ
VISIERA SOLARE

441725U Ø18
441726Y Ø30 - 2 POSITIONS

> NEO

TNT
Helmets



TNT
Helmets

NORMES ECE 22-05

- Coque en polycarbonate
 - Calotte en EPS
 - Tissu hypoallergénique, démontable et lavable
 - Ecran sphérique
 - Jugulaire à boucle rapide et a réglages micrométriques
- Calotta in polycarbonato
 - Interno Calotta in EPS
 - Interneco pelle ipoallergico ed estraibile
 - Visiera sferica antigraffio
 - Chiusura sottocollo a gancio rapido



MAT OPACO	XS	S	M	L	XL	XXL
NOIR NERO	441766	441766A	441766B	441766C	441766D	441766E

> ACCESSOIRES - ACCESSORI

TNT
Helmets



FIXATION
FIXATION
441766G



ECRAN INCOLORE
SCREEN COLOURLESS
441766F

* Adaptable
* Adattabile

Les références du constructeur sont seulement indicatives et n'impliquent pas que les pièces de rechange viennent du constructeur.
I codici di riferimento originali sono indicativi e non implicano che i ricambi provengano necessariamente dalla stessa fabbrica del costruttore.

➤ APOLLO



NORMES ECE 22-05

- Coque en polycarbonate
 - Calotte en EPS
 - Tissu hypoallergénique
 - Ecran sphérique
 - Jugulaire à boucle rapide et à réglages micrométriques
- Calotta in policarbonato
 - Interno Calotta in EPS
 - Tessuto ipoallergico ed estraibile
 - Visiera sferica
 - Chiusura sottocollo a gancio rapido

	BRILLANT BRILLANTE	XS	S	M	L	XL
3	NOIR NERO	441827L	441827M	441827N	441827O	441827P

➤ ACCESSOIRES - ACCESSORI



ECRAN INCOLORE
 VISIERA INCOLORE
 441829



FIXATION MAT
 FISSAGGIO OPACO
 441829C NOIR NERO



FIXATION BRILLANTE
 FISSAGGIO BRILLANTE
 441829E NOIR NERO



FIXATION BRILLANTE
 FISSAGGIO BRILLANTE
 441829F GRIS GRIGIO



FIXATION MAT
 FISSAGGIO OPACO
 441829H BLANC BIANCO

➤ **URBAN**

ALT-1



ALT-1

NORMES ECE 22-05

- Coque en polycarbonate
- Calotte en EPS
- Tissu hypoallergénique, démontable et lavable
- Ecran sphérique
- Jugulaire à boucle rapide et a réglages micrométriques

- Calotta in polycarbonato
- Interno Calotta in EPS
- Tessuto ipoallergico ed estraibile
- Visiera sferica antigraffio
- Chiusura sottocollo a gancio rapido

3



1

2

4

	BRILLANT BRILLANTE	XS	S	M	L	XL	XXL
1	BLANC BIANCO	441003	441003A	441003B	441003C	441003D	441003E
2	NOIR NERO	441001	441001A	441001B	441001C	441001D	441001E
3	GRIS GRIGIO	441015	441015A	441015B	441015C	441015D	441015E
	MAT OPACO						
4	NOIR NERO	441002	441002A	441002B	441002C	441002D	441002E

➤ **ACCESSOIRES - ACCESSORI**

ALT-1



FIXATION
 FIXATION
 441001Y



ECRAN INCOLORE
 VISIERA INCOLORE
 441001Z

* Adaptable
 * Adattabile

Les références du constructeur sont seulement indicatives et n'impliquent pas que les pièces de rechange viennent du constructeur.
 I codici di riferimento originali sono indicativi e non implicano che i ricambi provengano necessariamente dalla stessa fabbrica del costruttore.

EQUIPEMENT PILOTE ABBIGLIAMENTO MOTO

CASQUES CASCHI

> CRACKED



N
NIT END

2

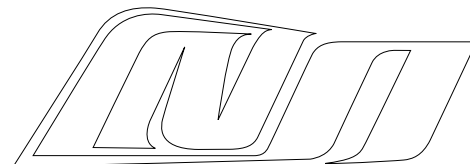

- Coque en polycarbonate
- Intérieur confortable, démontable et lavable
- Large découpe pour un confort visuel maximum
- Guide anti-glissement masque
- Boucle double D
- Poids : 1300 ± 50 grs

- Calotta in polycarbonato
- Interno confortevole, smontabile e lavabile
- Ampia apertura per una massima visibilità
- Sistema di aereazione top traspirabilità
- Chiusura OM gara doppia DD
- Peso : 1300g ± 50g



1



3



4



5

ENFANT BAMBINO

	BRILLANT BRILLANTE	YS	YM	YL	VISIÈRE
1	BLEU/JAUNE BLU/GIALLO	441960	441960A	441960B	441960Y
2	ROUGE/NOIR ROSSO/NERO	441961	441961A	441961B	441961Y
3	VERT/NOIR VERDE/NERO	441962	441962A	441962B	441962Y
4	FR/USA	441963	441963A	441963B	441963Y
5	ORANGE/NOIR ARANCIONE/NERO	441964	441964A	441964B	441964Y

ADULTE ADULTO

	BRILLANT BRILLANTE	XS	S	M	L	XL	XXL	VISIÈRE
1	BLEU/JAUNE BLU/GIALLO	441960C	441960D	441960E	441960F	441960G	441960H	441960Z
2	ROUGE/NOIR ROSSO/NERO	441961C	441961D	441961E	441961F	441961G	441961H	441961Z
3	VERT/NOIR VERDE/NERO	441962C	441962D	441962E	441962F	441962G	441962H	441962Z
4	FR/USA	441963C	441963D	441963E	441963F	441963G	441963H	441963Z
5	ORANGE/NOIR ARANCIONE/NERO	441964C	441964D	441964E	441964F	441964G	441964H	441964Z

> ACCESSOIRES - ACCESSORI



KIT VIS - FISSAGGIO
441846Y

EQUIPEMENT PILOTE ABBIGLIAMENTO MOTO

CASQUES CASCHI

> DEFCON BY OCD

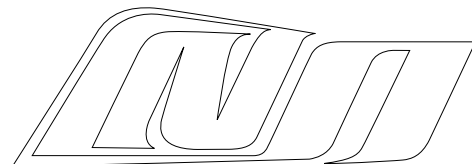

- Coque en polycarbonate
- Intérieur confortable, démontable et lavable
- Large découpe pour un confort visuel maximum
- Guide anti-glisement masque
- Boucle double D
- Poids : 1300 ± 50 grs

- Calotta in policarbonato
- Interno confortevole, smontabile e lavabile
- Ampia apertura per una massima visibilità
- Sistema di aereazione top traspirabilità
- Chiusura OM gara doppia DD
- Peso : 1300g ± 50g



	BRILLANT BRILLANTE	XS	S	M	L	XL	XXL
1	PATRIOT	441871	441871A	441871B	441871C	441871D	441871E
2	WHITE/BLUE	441872	441872A	441872B	441872C	441872D	441872E
3	WHITE/RED	441873	441873A	441873B	441873C	441873D	441873E
4	ORANGE	441874	441874A	441874B	441874C	441874D	441874E
5	BLUE/YELLOW	441875	441875A	441875B	441875C	441875D	441875E

> ACCESSOIRES - ACCESSORI



KIT VIS - FISSAGGIO
441846Y



VISIÈRE - VISIERA
441871Z PATRIOT



VISIÈRE - VISIERA
441872Z WHITE/BLUE



VISIÈRE - VISIERA
441873Z WHITE/RED



VISIÈRE - VISIERA
441874Z ORANGE



VISIÈRE - VISIERA
441875Z BLUE/YELLOW

* Adaptable
* Adattabile

Les références du constructeur sont seulement indicatives et n'impliquent pas que les pièces de rechange viennent du constructeur.
I codici di riferimento originali sono indicativi e non implicano che i ricambi provengano necessariamente dalla stessa fabbrica del costruttore.

EQUIPEMENT PILOTE ABBIGLIAMENTO MOTO

CASQUES CASCHI

> OCD STAR

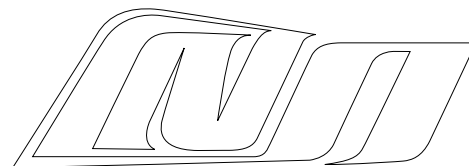

NORMES ECE 22-05

- Coque en polycarbonate
 - Intérieur confortable, démontable et lavable
 - Ecran 5 positions et démontable rapidement
 - Ecran fumé rétractable
 - Nombreuses aérations
 - Fermeture rapide et efficace grâce à la boucle micrométrique
 - Homologué CE
 - Poids : 1400 ± 50 grs
- Calotta in policarbonato
 - Interno confortevole
 - Visiera con 5 posizioni e smontaggio rapido
 - Visiera solar retrattile
 - Numerose aereazioni
 - Chiusura rapida ed efficace grazie alla sicurezza micrometrica
 - Omologato CE
 - Peso : 1400 ± 50 g



4



3



2



1

		XS	S	M	L	XL	XXL
1	BLUE	441875	441875A	441875B	441875C	441875D	441875E
2	RED	441876	441876A	441876B	441876C	441876D	441876E
3	GREEN	441877	441877A	441877B	441877C	441877D	441877E
4	PATRIOT	441878	441878A	441878B	441878C	441878D	441878E

> ACCESSOIRES - ACCESSORI



ECRAN INCOLORE
VISIERA INCOLORE
441748H

➤ **OCD STAR KID**

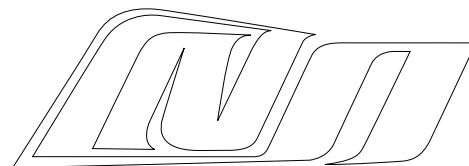

NORMES ECE 22-05

Design exclusif by ocd pour les graines de champions !

- Coque en polycarbonate
- Intérieur confortable, démontable et lavable
- Ecran 5 positions et démontable rapidement
- Nombreuses aérations
- Fermeture rapide et efficace grâce à la boucle micrométrique
- Homologué CE
- Poids : 1200 ± 50 grs

- Calotta in polycarbonato
- Interno confortevole
- Visiera con 5 posizioni e smontaggio rapido
- Numerose aereazioni
- Chiusura rapida ed efficace grazie alla sicurezza micrometrica
- Omologato CE
- Peso : 1200 ± 50 g



1



2



3

		YS	YM	YL
1	BLUE	441887	441887A	441887B
2	RED	441888	441888A	441888B
3	GREEN	441889	441889A	441889B

➤ **ACCESSOIRES - ACCESSORI**



ECRAN INCOLORE
 VISIERA INCOLORE
 441890Z

* Adaptable
 * Adattabile

Les références du constructeur sont seulement indicatives et n'impliquent pas que les pièces de rechange viennent du constructeur.
 I codici di riferimento originali sono indicativi e non implicano che i ricambi provengano necessariamente dalla stessa fabbrica del costruttore.



2



ALT-1

- Coque en polycarbonate
- Intérieur confortable, démontable et lavable
- Ecran 5 positions et démontable rapidement
- Nombreuses aérations
- Fermeture rapide et efficace grâce à la boucle micrométrique
- Homologué CE
- Poids : 1500 ± 50 grs

- Calotta in polycarbonato
- Interno confortevole
- Visiera con 5 posizioni e smontaggio rapido
- Numerose aereazioni
- Chiusura rapida ed efficace grazie alla sicurezza micrometrica
- Omologato CE
- Peso : 1500 ± 50 g



1



3

	BRILLANT BRILLANTE	XS	S	M	L	XL	XXL
1	NOIR NERO	441013	441013A	441013B	441013C	441013D	441013E
2	BLANC BIANCO	441018	441018A	441018B	441018C	441018D	441018E
	MAT OPACO						
3	NOIR NERO	441014	441014A	441014B	441014C	441014D	441014E



ECRAN INCOLORE
 VISIERA INCOLORE
 441014Z

➤ MINO KID

TNT
 Helmets



TNT
 Helmets

NORMES ECE 22-05

- Coque en polycarbonate
 - Protège nez
 - Jous démontables et lavables
 - Ecran 5 positions, démontable rapide
 - Aérations mentonnière et crâne
 - Boucle à attache rapide
 - Poids : 1150 ± 50 grs
- Calotta in policarbonato
 - Para naso
 - Set interno smontabile e lavabile
 - Visiera 5 posizioni, smontaggio rapido
 - Aerazione mentoniera e testa
 - Anelli a fissaggio/regolazione rapida
 - Peso 1150 ± 50 g

	BRILLANT BRILLANTE	S	M	L
1	BLANC BIANCO	441741A	441741B	441741C
2	NOIR NERO	441742A	441742B	441742C
3	SILVER ARGENTO	441743A	441743B	441743C

* Adaptable
 * Adattabile

Les références du constructeur sont seulement indicatives et n'impliquent pas que les pièces de rechange viennent du constructeur.
 I codici di riferimento originali sono indicativi e non implicano che i ricambi provengano necessariamente dalla stessa fabbrica del costruttore.

➤ 3.6 SERIES



3.6 SERIES

- Monture semi rigide pour une application optimale sur le visage
- Mousse confort hypoallergénique simple densité
- Ecran polycarbonate anti buée
- Support de tear off intégrés
- Bandeau ajustable silicone 3 vagues

- Struttura semi-rigida per una vestibilità ottimale sul viso
- Spugna comfort ipoallergenica densità media
- Visiera in policarbonato anti-fog
- Supporto per tear off integrato
- Fascia regolabile con 3 bande silicone antiscivolo



3.6 SERIES

448400	NOIR NERO
448400A	BLANC BIANCO
448400B	ROUGE ROSSO
448400C	BLEU BLU
448400D	ORANGE ARANCIONE
448400E	VERT VERDE
448400I	JAUNE GIALLO



ECRAN SEUL VISIERA

448400H	TRANSPARENT TRASPARENTE
448400J	JAUNE GIALLO
448400K	BLEU BLU



TEAR OFF

448400G	X10
---------	-----



3.6 KID SERIES

448402	NOIR NERO
448402A	BLANC BIANCO
448402B	ROUGE ROSSO
448402C	BLEU BLU

> **PROGRIP**



3204

- | | | |
|---------|-------------|-----------|
| 448120L | ROUGE FLUO | ROSSO |
| 448120M | JAUNE FLUO | GIALLO |
| 448120N | VERT FLUO | VERDE |
| 448120O | ORANGE FLUO | ARANCIONE |



3301

- | | | |
|---------|---------------------------|--|
| 448120J | NOIR + VERRE SENSITIVE | |
| | BNERO + VISIERA SENSITIVA | |
| 448120K | VERRE SENSITIVE RECHANGE | |
| | VISIERA DI RICAMBIO | |



3301

- | | | |
|---------|--------|-----------|
| 448120 | ROUGE | ROSSO |
| 448120A | ARGENT | ARGENTO |
| 448120B | JAUNE | GIALLO |
| 448120C | VERT | VERDE |
| 448120D | ORANGE | ARANCIONE |
| 448120E | BLEU | BLU |
| 448120F | BLANC | BIANCO |
| 448120G | NOIR | NERO |

TEAR OFF

- | | | |
|---------|-----|-----|
| 448120H | X10 | (1) |
| 448120I | | (2) |



(2)



(1)

* Adaptable
 * Adattabile

Les références du constructeur sont seulement indicatives et n'impliquent pas que les pièces de rechange viennent du constructeur.
 I codici di riferimento originali sono indicativi e non implicano che i ricambi provengano necessariamente dalla stessa fabbrica del costruttore.

EQUIPEMENT PILOTE ABBIGLIAMENTO MOTO

HABILLEMENT ANTIPOGGIA & SOTTOCASCO



- Veste avec pantalons 100% étanche avec bandes réfléchissantes.
- Sac de transport 100% étanche.

- vestito con pantaloni impermeabili al 100% con bande rifrangenti



VESTE + PANTALON PLUIE

GIACCA + PANTALONE

503350	S
503351	M
503352	L
503353	XL
503354	XXL



GILET DE SECURITE

GILET DI SICUREZZA

S3337 HOMOLOGUE TAILLE XL



SOUS GANTS COTON

SOTTOGUANTI

447901	S
447901A	M
447901B	L
447901C	XL



TOUR DE COU

SCALDACOLLO POLARE

440175A NEOPRENE



CAGOLE SOIE

SCALDACOLLO POLARE

440200	HUBLLOT	(1)
440200A	CHOUETTE	(2)

➤ **VESTE JACKET GIACCHETTA**

NOEND



VESTE ELEMENTARY

100% coupe-vent, chaude et polyvalente !
 Dynamique, cette veste softshell décline protection totale au vent, déperlance durable à l'eau et résistance à l'usure dans une formule assouplie et allégée. L'intérieur en maille mesh assure la respirabilité nécessaire et le bon maintien des protections. Efficace pour de nombreuses conditions climatiques rencontrées sur tous les trajets quotidiens, elle privilégie le bien-être d'une ergonomie confortable et d'un style facilement détournable au quotidien.

Caractéristiques :

- Coupe confortable et protectrice
- Capuche ajustable et amovible
- 1 poche poitrine zippée
- 1 poche portefeuille intérieure
- 1 poche CB au bras gauche
- Fermeture centrale zippée avec sous-patte de protection
- Poignets et bas ajustables
- Protections coudes & épaules homologuées **CE**

ELEMENTARY

BLOUSON SOFTSHELL + PROTECTIONS CE

504444 XS

504444A S

504444B M

504444C L

504444D XL

504444E XXL



VESTE HI-TECH

L'élégance d'une veste citadine dans un équipement moto !

Sa structure softshell incroyablement souple et l'ergonomie de ses protections CE vous fera oublier que la Hi-Tech est un équipement technique, chaud, étanche, et adapté à la pratique quotidienne du deux roues motorisé.

Caractéristiques :

- Coupe élégante et confortable
- Col haut avec doublure fourrure synthétique amovible
- Doublure thermique amovible
- 2 poches poitrine zippées
- 2 poches portefeuille ou smartphone intérieures
- 2 poches cargo
- 1 poche CB au bras gauche
- Fermeture centrale zippée avec sous-patte de protection boutonnable
- Poignets et taille ajustable par sangle
- 2 Zips d'aisance au bas du dos
- Protections coudes & épaules homologuées **CE**

HI-TECH

VESTE SOFTSHELL + PROTECTIONS CE

504445 XS

504445A S

504445B M

504445C L

504445D XL

504445E XXL



* Adaptable
 * Adattabile

Les références du constructeur sont seulement indicatives et n'impliquent pas que les pièces de rechange viennent du constructeur.
 I codici di riferimento originali sono indicativi e non implicano che i ricambi provengano necessariamente dalla stessa fabbrica del costruttore.



SUPPORT UNIVERSEL IMPERMEABLE
CUSTODIA/ASTUCCIO IMPERMEABILE

540016F TELEPHONE / GPS ADAPT SCOOTER / MOTO



SUPPORT UNIVERSEL IMPERMEABLE
CUSTODIA/ASTUCCIO IMPERMEABILE

540016G TELEPHONE / GPS ADAPT SCOOTER / MOTO
 FIXATION GUIDON FISSAGGIO MANUBRIO



CHARGEUR USB UNIVERSEL 3GS /4G
CARICA USB UNIVERSALE 3GS /4G

540016D VOITURE / SCOOTER / MOTO



CHARGEUR DOUBLE USB UNIVERSEL
CARICA DOPPIO USB UNIVERSALE

540016E SCOOTER / MOTO 12V / 2.1A

FIXATION GUIDON OU PERÇAGE
 FISSAGGIO MANUBRIO O PÉRFORAZIONE



POIGNEE CHAUFFANTE
MANOPOLE RISCALDANTE

323301 UNIVERSEL MOTO/SCOOTER L.130

The background features several large, overlapping, abstract shapes in a vibrant yellow color against a solid black background. These shapes include a large, curved, teardrop-like form in the upper right, a long, diagonal rectangular shape in the lower left, and a large, irregular shape in the lower right. The shapes are defined by thick black outlines and create a dynamic, modern composition.

OUTILLAGE

> OUTILLAGE ATELIER

ATTREZZI

> ATTREZZI OFFICINA

OUTILLAGE ATTREZZI

OUTILLAGE ATELIER ATTREZZI OFFICINA



CLIP VERSEUR MULTI USAGE
IMBUTO MULTIUSO PVC FLESSIBILE
 622009A



ENTONNOIR MULTI USAGE FLEXIBLE
IMBUTO MULTI FUNZ. FLESSIBILE
 622009



DOSEUR D'HUILE DOUBLE MINIMAX
COPPIA DOSATORI OLIO MINIMAX
 622011A



RECUPERATEUR D'HUILE
IMBUTO MULTIUSO PVC FLESSIBILE
 622009B 7 L



DOSEUR GRADUE IPONE
BROCCA IPONE GRADUATA
 S47100A 2 L



DOSEUR GRADUE
BROCCA GRADUATA
 S47100B 5 L



BOITE DE 110 COLLIERIS ASSORTIS
CASSETTA DA 110 FASCETTE ASSORTITE
 541100



COFFRET JOINTS TORIQUE 400 PCS
COFANETTO GUARNIZIONI O-RING 400 PZ.
 541105 34 TAILLES DIMENSIONE

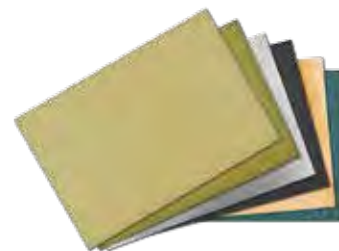

FEUILLES A4 POUR REALISER DES JOINTS
FOGLI A4 PER REALIZZO GUARNIZIONI

070000	PAPIER CARTA 0,3 MM
070000A	PAPIER CARTA 0,5 MM
070000B	FIBRE FIBRA 0,5 MM
070000C	GRAPHIC + GRILLE 1,25 MM
070000D	CUIVRE RAME 0,35 MM
070000E	ALU. ALLUMINIO 0,35 MM



COSSES ELECTRIQUE MALE/FEMELLE
FASTON/CAPICORDA M/F

500063A	2 CONNECTIONS	X1
500063D	3 CONNECTIONS	X1
500063B	4 CONNECTIONS	X1
500063C	6 CONNECTIONS	X1
500063E	1 CONNECTIONS WATERPROOF	X1



COFFRET ASSORTIMENT DE FUSIBLES
COFANETTO ASSORTIMENTO FUSIBILI

500068	X 250
--------	-------



ASSORTIMENT DE FUSIBLES
ASSORTIMENTO FUSIBILI

500066	6 X 30 8A	X10
500066A	6 X 30 10A	X10
500066B	6 X 30 15A	X10

OUTILLAGE ATTREZZI

OUTILLAGE ATELIER ATTREZZI OFFICINA



COFFRET COSSES ELECT. + PINCE
COFANETTO BAGCELLI ELETTRICI CON PINZA

500064 200 PIECES PEZZI



COFFRET COSSES ELECTRIQUES
COFANETTO BAGCELLI ELETTRICI

500064A 165 PIECES PEZZI



COFFRET GAINES RETRACTABLES
COFANETTO GUAINA RITRATTABILI

500063 74 PIECES PEZZI



CABLES DEMARRAGE MOTO / SCOOTER / QUAD
CAVI DI PARTENZA MOTO / SCOOTER / QUAD

540014 (16mm²) 240A (L= 2 X 3M)



MAGNETISEUR / DEMAGNETISEUR
MAGNETIZZATORE

541050N



PINCE A DURITE ESSENCE UNIVERSEL
PINZA PER TUBO BENZINA UNIVERSALE

541050P



PINCE A DENUDER + COUPE FIL
PINZA SPELA FILI ELETTRICI

540021B



PINCE A SERTIR
PINZA STRIGI CAPOCORDA ELETTRICI AUTOMAT.

540021A



PINCE A FREINER
PINZA GRIP A COMPASSO PER TORSIONE

541050H 50M X 25mm



PINCE A CIRCLIPS UNIVERSELLE
PINZA SIEGER UNIVERSALE AD APRIRE

970911



COFFRET CIRCLIPS A OEIL
COFANETTO SIEGER CON DIVISORIE ASSORTITO

500064B 300 PIECES PEZZI



CLE DEMONTE EMBRAYAGE
CHIAVE SMONTA FRIZIONE

540022 PIAGGIO Ø34

540022A PIAGGIO Ø39

541021 MINARELLI Ø41 (1)

541022 MINARELLI Ø46



CLES DE VARIATEUR/EMBRAYAGE/CORRECTEUR
CHIAVI DI VARIATORE / FRIZIONE / CORRETTORE

540503 *YAMAHA TMAX 500-530



BLOQUE VARIATEUR
ATTREZZO BLOCCAGGIO VARIATORE

540015 *PIAGGIO MP3

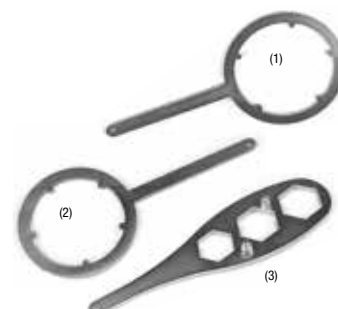

CLE DEMONTE EMBRAY. EASYBOOST
CHIAVE SMONTA FRIZIONE

540500 MINARELLI Ø46 (1)

540501 DERBI EURO 2/3 (2)

540502 SCOOTER UNIVERSEL 4 EN 1 (3)

* Adaptable
* Adattabile

Les références du constructeur sont seulement indicatives et n'impliquent pas que les pièces de rechange viennent du constructeur.
I codici di riferimento originali sono indicativi e non implicano che i ricambi provengano necessariamente dalla stessa fabbrica del costruttore.



PURGEUR MANUEL DE LIQUIDE DE FREINS
SPURGO MANUALE LIQUIDO FRENI
 541050Q



ARRACHE ROULEMENT UNIVERSEL
SET ESTRATTORE CUSCINETTI UNIVERSALE
 5410500 50-75 MM



BLOQUE PISTON
BLOCCO PISTONE
 540010 M14 X 1,25 2 TEMPS (1)
 540010A M12 X 1,25 4 TEMPS CULOT D
 540010B M10 X 1,25 4 TEMPS CULOT C



FIL A FREINER INOX
FILO DI SICUREZZA IN ACCIAIO INOX
 541050K 0,6 MM X 20 M



SCOTCH WELD RT41
FREIN FILETT FORT (VERT)
FRENA FILETTI 3M FORTE (VERDE)
 S3769 500 ML



SCOTCH WELD RT43
FREIN FILETT MOYEN (BLEU)
FRENA FILETTI 3M MEDIO (BLU)
 S3814 500 ML

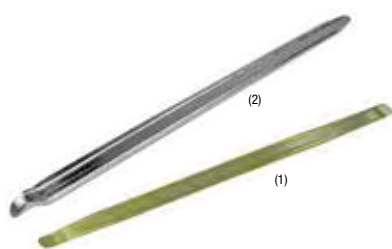

DEMONTE PNEU METAL
SMONTA PNEUMATICI METAL
 543610A L.350mm (1)
 543610B L.500mm (2)

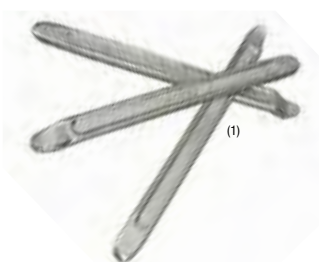

JEU DE 3 DEMONTE PNEU METAL
KIT 3 SMONTA PNEUMATICI METAL
 543611 L.240 MM (1)
 543612 L.300 MM



DEMONTE PNEU METAL
SMONTA PNEUMATICI METAL
 541050J L.270mm (CROSS)



CLE A BOUGIE
CHIAVE CANDELA
 541015 SCOOTER 21 MM



CLE A BOUGIE SCOOTER 4TEMPS
CHIAVE SMONTA CANDELA SCOOTER 4T
 541015A 16mm

new



CLE UNIVERSELLE
CHIAVE UNIVERSALE
 970911B 8 MM

OUTILLAGE ATTREZZI

OUTILLAGE ATELIER ATTREZZI OFFICINA



CLE EN T JEU DE 7 PIECES
SET DI 7 CHIAVI A T NERE
541050F 8/10/12 MM + 2 JEU PHILLIPS



CLE EN T 3 EN 1 AVEC DOUILLE
CHIAVE A T CON INSERTI A BUSSOLA
541050C 8/10/12 MM



CLE A CLIQUET POUR BOUGIE
LLAVE BUJIA DE CARRACA
541050G 21 MM



DEMONTE SOUPAPE UNIVERSEL
COMPRESI MOLLE VALVOLE
540008



JEU DE CALE CONTROLE SOUPAPE
SPESSIMETRO PER CONTROLLO
541050E



CLE DOUBLE REGLAGE SOUPAPE
CHIAVE PER REGOLAZIONE VALVOLE
970911A



ARRACHE VOLANT 3 VIS
ESTRATTORE VOLANO 3 VITI
541050M 75mm



ARRACHE VOLANT
ESTRATTORE VOLANO

- 540026 UNIVERSEL Ø65MM
- 540200 *MOB/PIAGGIO/STRADA/FYM
- 540210 *MOB/AM6/BUXY/DERBI SENDA (1)
- 540220 *CPI SM/SX
- 540300 *103
- 540315 *BOOSTER/SCOOT CPI/PIAGGIO/MBK
- 540316 *MVT
- S5255 *CIAO Ø17MM
- 970889P *TNT MOTORS CITY 1 & 2

JAUGE REGLAGE AVANCE
REGOLATORE ANTICIPO
540015



DOUILLE 6 PANS ROUE AVANT
ATTREZZO PROFESSIONALE A PRESA ESAGONALE
540318



JEU DE 3 PROTEGE JANTE
KIT DI 3 PROTEGGI CERCHIO
543613



REPOUSSE PISTON ETRIER
ATTREZZO BLOCCO/RIENTRO PISTONCINI
540318A MOTO/SCOOTER



SERINGUE DE NIVEAU DE FOURCHE
SIRINGA PER OLIO FORCELLE
541050L 60 ML



TIR VALVE TUBELESS
TIR VALVE TUBELESS
255005GL

* Adaptable
* Adattabile

Les références du constructeur sont seulement indicatives et n'impliquent pas que les pièces de rechange viennent du constructeur.
I codici di riferimento originali sono indicativi e non implicano che i ricambi provengano necessariamente dalla stessa fabbrica del costruttore.

OUTILLAGE ATTREZZI

OUTILLAGE ATELIER ATTREZZI OFFICINA



DERIVE CHAINE
APRI MAGLIE CATENA
240000



CLE A RAYON
CHIAVE RAGGI
540023 5,65 A 6,85



TIRE RESSORT
TIRA MOLLA
540020



DOUILLE CRANTEE EMNRAYAGE
BUSSOLA DENTATA FRIZIONE
970911C PIT BIKE & DAX



DEMONTE CARTOUCHE FILTRE A HUILE
CHIAVE SMONTA CARTUCCE FILTRO OLIO
540024 Ø60MM A Ø100MM (1)
540024A Ø60MM A Ø105MM (2)



MULTIMETRE DIGITAL
TESTER MULTIMETRO DIGITALE
540017C 12V



RODOIR ET JEU DE PIERRE
SMERIGLIA CILINDRO + PIETRE
540005 RODOIR / CYLINDER HONING (1)
540006 JEU DE PIERRES / STONES (2) X3



TOILE ADHESIVE
NASTRO ADESIVO
500310A 48 MM X 30 M ■
500312A 48 MM X 30 M ■



ADHESIF ALUMINIUM
NASTRO ADESIVO ALLUMINIO
500315 50 MM X 5 M



ADHESIF ISOLANT PVC
ADESIVO ISOLANTE PVC
500051 19 MM X 10 M ■



BALADEUSE DE POCHE
LAMPADA TASCABILE DA LAVORO
540017D LED



PLATEAU MAGNETIQUE
PIATTO MAGNETICO PROFESSIONALE
540019A Ø 150 MM



PLATEAU MAGNETIQUE
VASSOIO MAGNETICO
540019 240 MM X 140 MM X 45 MM



TIGE TELESCOPIQUE MAGNETIQUE
CALAMITA MAGNETICA TELESCOPICA
540025 CAPACITÉ 0,5 KG (1)
540025A CAPACITÉ 5 KG (2)



POMPE MANUELLE POUR FUT
POMPA MANUALE PER FUSTO
543590B



POMPE MANUELLE A GASOIL
POMPA MANUALE CARBURANTE
543590A



POMPE A PURGER LES FREINS
POMPA PNEUMATICA PER SPURGO FRENI
541050I

OUTILLAGE ATTREZZI

OUTILLAGE ATELIER ATTREZZI OFFICINA



PIED À COULISSE DIGITAL
CALIBRO DIGITALE

543620 15 MM



MANOMETRE DIGITAL
MANOMETRO DIGITALE

540017E



GRAISSEUR DE CABLE UNIVERSEL
INGRASSATORE PER CAVI UNIVERSALE

160070A



TESTEUR DE COMPRESSION POUR MOTEUR
MISURA COMPRESSIONE CILINDRO

540007



MANOGONFLEUR UNIVERSEL
PISTOLA GONFIA PNEUM. UNIVERSALE

540017



SOUFFLETTE D'ATELIER
PISTOLA ARIA PER OFFICINA

540017B 1 L



COFFRET 8 EMBOUTS 6 PANS
COFANETTO DI 8 BUSSOLE ESAGONALI VANADIUM

549795N 10 / 11 / 12 / 13 / 14 / 17 / 19 / 22



TOURNEVIS A FRAPPER AVEC EMBOUTS
CACCIAVITE FORTE PRESA A CRICCHETTO 4 INSERTI

541050D

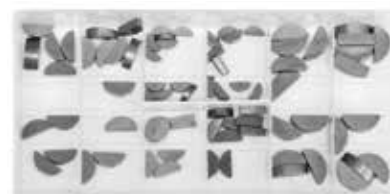

COFFRET ASSORTIMENT CLAVETTES 1/2 LUNE
COFANETTO DI CHIAVETTE MEZZALUNA

500064C 80 PIECES 80 PIECES



BOITE A CLIQUETS 46 PIECES
CASSETTA CHIAVI A CRICCHETTO 46 PEZZI

541050A



CLEFS A CHOCS 1/2 + 10 DOUILLES
PISTOLA PNEUMATICA 1/2 + 10 BUSSOLE

541055



FRAISEUSE PNEUMATIQUE + FRAISES
FRESINO PNEUMATICO + FRESE

541055A



COFFRET TARAUDS + FILIERES 110 PIECES
COFANETTO MASCHI + FILIERE 110 PEZZI
 541060



COFFRET REPOUSSE PISTON 18 PIECES
COFANETTO PROFESSIONALE RESPINGI PISTONE
 549795J



COFFRET 8 EMBOUSES BTR
COFANETTO 8 BUSSOLE VANADIUM + PROLONGHE BTR
 549795M H4 / H5 / H6 / H7 / H8 / H10 / H12 / H14



OUTIL DIAGNOSTIC INJECTION OBD2
SET DIAGNOSTICA OBD2
 540017F UNIVERSEL (MULTI LANGUAGE)

INTERFACCIA/PROGRAMMA/CONNESSIONI
 MUTILINGUA



BALADEUSE
LAMPADA DA LAVORO

540016 NEON 220 VOLTS 8 WATTS (1)
 540016A LEDS RECHARGEABLE REFILLABLE LEDS (2)



LUNETTE DE PROTECTION TRANSPARENTE
OCCHIALI DI PROTEZIONE TRASPARENTI

540018



FONTAINE DE LAVAGE 220 V
VASCA PER LAVAGGIO 220 V
 549720A 13 L



RESERVOIR AUXILIAIRE CARBURANT
RISERVA AUSILIARIA CARBURANTE

420000 1 L



FONTAINE DE LAVAGE 220 V
VASCA PER LAVAGGIO 220 V
 549720 151 L



JEU DE 2 SANGLES MOTO
KIT DI 2 CINGHIE DI FISSAGGIO
 2550056L 25 MM X 2 M



BOULE ATTELAGE 4X4 3.5T
SFERA PER GANCIO TRAINO

549795E



BAGUE DE MONTAGE REGLABLE 32 A 46
ANELLO REGOLABILE DA 32 A 46

540321 JOINT SPY MOTO/SCOOTER

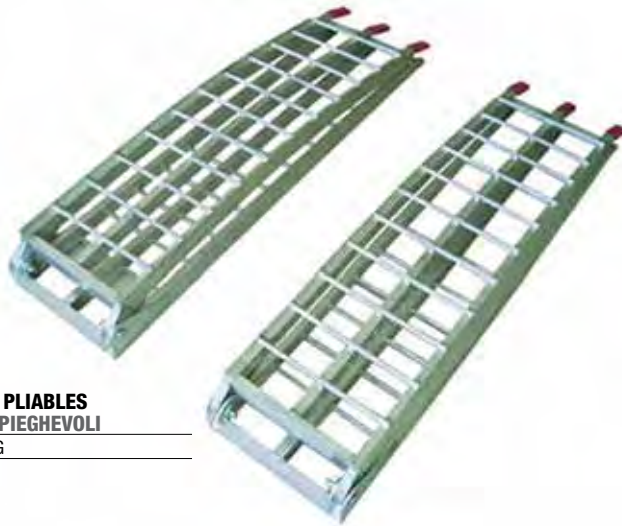

PAIRE RAMPES ALUMINIUM PLIABLES
COPPIA RAMPE ALLUMINIO PIEGHEVOLI
 549850 230 CM X 28 CM 360 KG



BEQUILLE UNIVERSELLE MOTO CROSS
CAVALLETTO PER MOTOCROSS, UNIVERSALE
 549825B



LEVE MOTO ARRIERE
ALZA MOTO POSTERIORE TAMPONI/FORCHETTE
 549826



BEQUILLE DE PONT MOTO
CAVALLETTO PONTE SOLLEVA MOTO
 549780C











LEVE MOTO CROSS
ALZA MOTO CROSS
 549825



PONT A COLONNE POUR MOTO
PONTE A COLONNA PER MOTO
 549780B

TNT[®]
MOTOR



	COMMERCIAL	TELEPHONE	EMAIL	ASSISTANCE A.D.V.	
	FRANCE				
	Stéphane BERTHON 16-17-19-23-24-33-36-79-86-87	06 83 47 02 23	sberthon@sacim.fr	 ANGERS 02 41 96 15 00	
	Juën DE HASQUE 60-75-77-78-91-92-93-94-95	06 31 74 04 13	jdehasque@sacim.fr		
	David CORDELETTE 02-27-51-59-62-76-80	06 88 46 83 26	dcordelette@sacim.fr		
	Laurent CHOPLIN 14-18-28-37-41-45-50-53-61-72	06 88 46 82 36	laurent.choplin@sacim.fr		
	Patrice LARCHER 22-29-35-44-49-56-85	06 78 69 75 81	plarcher@sacim.fr		
	Stéphane PIANELLI 04-06-12-13-30-34-48-83-84	06 84 80 82 30	spianelli@sacim.fr	 AVIGNON 04 32 74 30 00	
	Laurent PLICHON 01-03-05-07-26-38-42-43-58-63-69-71-73-74	06 88 46 83 48	lplichon@sacim.fr		
	Maxime BERNARD 2A-2B	06 33 19 07 06	mbernard@sacim.fr		
	Raphaël PORENTRU 10-21-25-39-52-54-55-57-67-68-70-88-90	06 88 46 82 57	rporentru@sacim.fr		
	Kevin GUIGARD 09-11-31-32-40-46-47-64-65-66-81-82	06 76 34 51 92	kguigard@sacim.fr		
	Stéphane BECH 08	00 32 47 49 78 036	sbech@sacim.fr		
	DEUTSCHLAND	Stéphane BECH	00 32 47 49 78 036	sbech@sacim.fr	
	NEDERLAND			Sébastien JUAREZ 0033 (0)432 743 027 sjuarez@sacim.fr	
	BELGIQUE				
	LUXEMBOURG				
	SUISSE	Nicolas LOCHE	06 70 03 62 84	nloche@sacim.fr	
	ITALIA	DISTRIBUTEUR DREAM MOTORS Salvo GARZIANO	0923 538 594	info@dreammotors.it	Ilaria BORSARELLI 0033 (0)432 743 022 iborsarelli@acsud.fr
		Andrea MOLINARI	348 9347050	amolinari@acsud.fr	
	EASTERN EUROPE	Andrea MOLINARI	00 39 348 9347050	amolinari@acsud.fr	
	MAGHREB				
	OTHER COUNTRIES		00 33 432 743 022	iborsarelli@acsud.fr	
	ESPAÑA	NORTE - CATALUÑA - ANDORRA			Sandra ALVES 0033 (0)432 743 025 salves@acsud.fr
		Dani CAMPO	00 33 658 879 952	dcampo@sacim.fr	
		CENTRO - SUR - CANARIAS - BALEARES			
		Dominique GARCIA	00 34 690 079 290	dgarcia@sacim.fr	
	PORTUGAL	Sandra ALVES	00 33 432 743 025	pmoreira@sacim.fr	
	DOM-TOM	Jean-Luc POISSON	00 33 676 769 567	jlpe exotic@wanadoo.fr	

Direction Commerciale France / Export

Nicolas LOCHE

06 70 03 62 84

nloche@sacim.fr

PASSAGE DE COMMANDES

AVEC L'AIDE DE VOTRE COMMERCIAL

PAR NOTRE SITE WWW.ACSUD-PRO.COM

CONSEIL TECHNIQUE MOTORISÉ

SAV ACCESSOIRES ET PIÈCES DÉTACHÉES

04 32 74 30 10

CONSEIL TECHNIQUE VÉLO

Rémi CERIZIER

02 41 96 15 00

IMMATRICULATION

ADV ANGERS

02 41 96 15 00

ADV AVIGNON

04 32 74 30 25

SAV TNT MOTOR & ARCHIVE

Philippe CARDOT

04 32 74 30 29

Alain BOISELLE

04 32 74 30 10



www.ACSUD-PRO.com

AVIGNON

135, rue Pierre Séward - Bât D3
 84000 Avignon - France
 Standard : +33 (0)4 32 74 30 00
 Fax : +33 (0)4 90 86 09 53
 contact@acsud.com

ANGERS

6, rue Michaël Faraday
 49070 Beaucouze - France
 Standard : +33 (0)2 41 96 15 00
 Fax : +33 (0)2 41 96 15 03
 contact@sacim.fr

